

Artikel-Nr.	0822-10v
Bezeichnung	CEE-Stecker 16A 2p 24/42VDC IP67 TWIST
Langbeschreibung	CEE-Stecker 16A 2p 24/42VDC IP67 TWIST Gehäusematerial: PA6 Nennstrom: 16A Polzahl: 2 (2P) Uhrzeit-Stellung: 10h Nennspannung/Frequenz: 24/42V DC Kontakte: Messing vernickelt Anschlussstechnik: Schraubklemmen Schutzart: IP67
GTIN (EAN)	9003399094934
Ursprungsland	AT
Zolltarifnummer	85366990
Nettogewicht	0,163 kg
Verpackungsmenge	10
Mindestbestellmenge	10

ETIM 9.0	EC000140
IEC-Stromstärke	16 A
Polzahl	2
Spannung nach EN 60309-2	<50 V DC grau
Uhrzeit-Stellung	10 h
Schutzart (IP)	IP67
Anschlussstechnik	Schraubklemme
Kabeleinführung	Verschraubung
Steckrichtung	gerade
Werkstoff	Kunststoff

a	135 mm
b	71 mm
K (Kabel Ø)	9,5-24 mm
SW	48 mm
Leitung flexibel	1-10 mm ²
Kontaktschrauben	160 Ncm
Zugentlastung	600 Ncm
Abmantelungslänge	70 mm
Abisolierlänge	14-16 mm
Umgebungstemperatur	-25 – 40 °C
Temperaturbeständigkeit	-25 – 80 °C

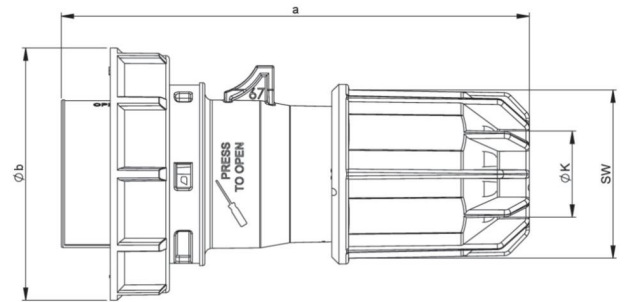

<https://www.pcelectric.at/shop/de/?func=detail&nr=0822-10v>

