

LUZ-TZ32 110.830.BW



Beschreibung

- Stromschieneleuchte in rechteckigem Design mit drehbarem Zentraladapter und Batwing-Lichtverteilung für spezielle Anforderungen der Warenbeleuchtung (z. B. Regalwege)
- hohe Wartungsfreundlichkeit
- keine UV- und Wärmestrahlung
- Gehäuse aus Stahlblech
- vorgesetzte Linsenoptik aus PMMA-Kunststoff matt
- 3-Phasen-Stromschieneadapter
- Betriebsgerät (LED-Konverter) integriert

Standardoptionen



Sonderoptionen



Farbe	Artikelnummer	EAN
silber	667549	4043544768469
schwarz	667550	4043544768476
weiß	667551	4043544768483

Lichttechnik / Normen

Leuchtmittel	LED Modul / CRI 80 / 3000 K
Lebensdauer	L90 B50 50.000 h L80 B50 100.000 h L80 B20 50.000 h
Systemleistung	64.8 W
Leuchten-Lichtstrom	9740 lm
Systemeffizienz	150.30 lm/W
Moduleffizienz	160.00 lm/W
UGR 4H/8H 70/50/20	22.6/24.3 (C0/C90)
Abstrahlwinkel	Batwing
Versorgungsspannung	220 - 240 V / 50 Hz
Schutzklasse	I
Schutzart	IP20

Abmessungen / Gewichte

Länge	587 mm
Breite	193 mm
Höhe	62 mm
Nettogewicht	2.58 kg
Bruttogewicht	2.72 kg

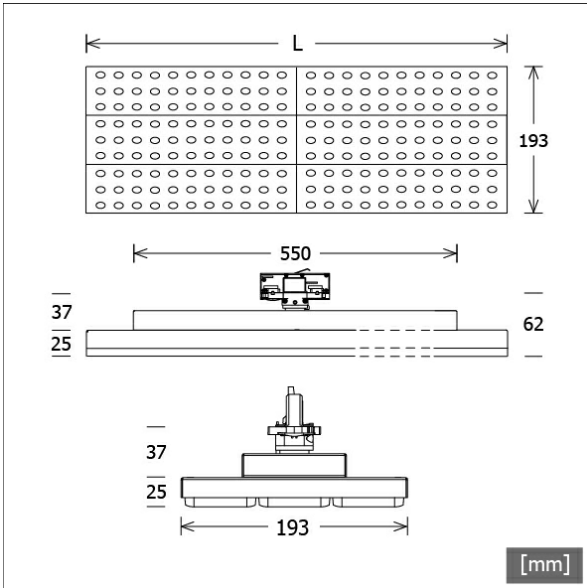

LUZ-TZ32 110.830.BW

LUZ-TZ32 110.830.BW

LUZ | Track-Mounted Central Adapter (1xLED 65W 830/3000K 9740lm)

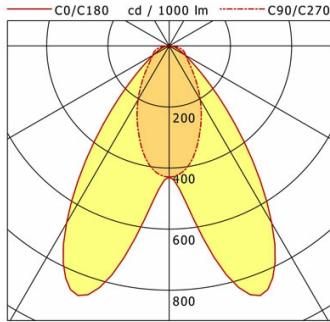

	C0	C90	C180	C270
0°	430	430	430	430
15°	800	346	800	346
30°	670	203	670	203
45°	213	102	213	102
60°	59	63	59	63
75°	22	43	22	43
90°	4	2	4	2
cd / 1000 lm				

LDC unsuitable for cone representation.
The C90 angle is oversized.

η	LED
Efficiency	150 lm/W
Direct/Indirect	↓ 99% / ↑ 1%
System Power	65 W
UGR	X=4H, Y=8H
Reflection factors	70/50/20
UGR C0/C180	22.6
UGR C90/C270	24.3
CIE Flux Codes	72 91 98 99 100
Ra/CRI	>80

LTS

Zubehör



EU 10
Anbau-Stromschiene Professional
(Länge: 1000 mm)



EU 20
Anbau-Stromschiene Professional
(Länge: 2000 mm)



EU 21
Anbau-Stromschiene Professional
(Länge: 3000 mm)



EU 22
Anbau-Stromschiene Professional
(Länge: 4000 mm)



EUE 20
Einbau-Stromschiene Professional
(Länge: 2000 mm)



EUE 21
Einbau-Stromschiene Professional
(Länge: 3000 mm)



EUE 22
Einbau-Stromschiene Professional
(Länge: 4000 mm)



ST-A 10/9000-1-ST
Anbau-Stromschiene ONETrack mit Datenbus
(Länge: 1000 mm)



ST-A 20/9000-2-ST
Anbau-Stromschiene ONETrack mit Datenbus
(Länge: 2000 mm)



ST-A 30/9000-3-ST
Anbau-Stromschiene ONETrack mit Datenbus
(Länge: 3000 mm)



ST-A 40/9000-4-ST
Anbau-Stromschiene ONETrack mit Datenbus
(Länge: 4000 mm)



ST-E 10/9000-1-R
Einbau-Stromschiene ONETrack mit Datenbus
(Länge: 1000 mm)

LUZ-TZ32 110.830.BW

Zubehör



ST-E 20/9000-2-R
Einbau-Stromschiene ONETrack mit Datenbus
(Länge: 2000 mm)



ST-E 30/9000-3-R
Einbau-Stromschiene ONETrack mit Datenbus
(Länge: 3000 mm)



ST-E 40/9000-4-R
Einbau-Stromschiene ONETrack mit Datenbus
(Länge: 4000 mm)