

Panel mounting appliance inlet - with hinged cover



Product description	
BALS-Prd.-Nr	2655
EAN	4024941026550
Product category	GT surface mounting appliance inlet
Current	32A
Number of poles	5p
Poles	3p+N+PE
Position of earth contact	6 h
Voltage	200/346 up to 240/415V
Frequency	50 and 60Hz

Product description	
Protection degree	IP44
Colour code	red RAL 3000
Colour of appliance	Hinged lid grey RAL 7035, Collar red RAL 3000, Enclosure grey RAL 7035
Connection design	with screw terminal
Maximum conductor size	6,0 qmm
Cable entry	other
Height	148mm
Width	90mm
Depth	116mm
Flange size vertical	75mm
Flange size horizontal	90mm
Drill hole distance vertical	45mm
Drill hole distance horizontal	78mm
Material of enclosure	Polyamide
Contact	The contact carrier is made of polyamide, The contacts are brass

Additional technical properties	
	With hinged lid

Logistics data	
Weight/pcs	0.337 kg / Piece

Logistics data	
Packaging	Bag
Content amount	1 ST
EAN	4024941026550
Length	116 mm
Width	90 mm
Height	148 mm
Weight	0.338 kg
Volume	1,545.12 ccm
Packaging	Carton
Content amount	10 ST
EAN	4024941967723
Length	325 mm
Width	217 mm
Height	210 mm
Weight	3.576 kg
Volume	13,588.4 ccm

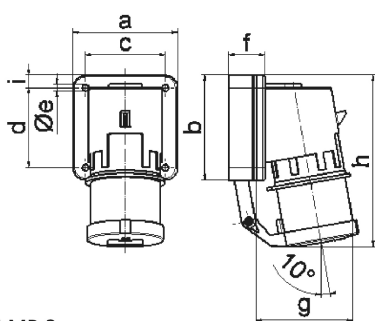

5 MB 2

Ampere Polzahl	16 3	16 4	16 5	32 3	32 4	32 5
a	74,0	75,0	84,0	90,0	90,0	90,0
b	84,0	100,0	84,0	75,0	75,0	75,0
c	58,0	62,0	64,0	78,0	78,0	78,0
d	64,0	74,0	64,0	45,0	45,0	45,0
e ø	5,5	4,3	5,5	5,5	5,5	5,5
f	12,0	12,0	29,0	29,0	29,0	29,0
g	78,0	88,0	105,0	114,0	114,0	115,0
h	134,0	151,0	138,0	149,0	149,0	150,0
i	-	-	-	13,0	13,0	13,0
Leiter mm ² min	1	1	1	2,5	2,5	2,5
Leiter mm ² max	2,5	2,5	2,5	6	6	6