

SCHALTBILDER

EZS 50/6 B

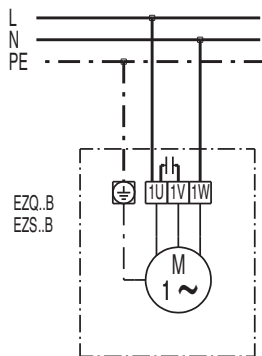

SCHALTBILDER

EZS 50/6 B

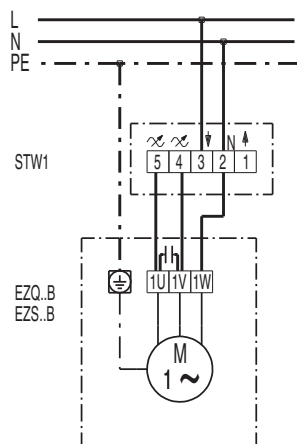
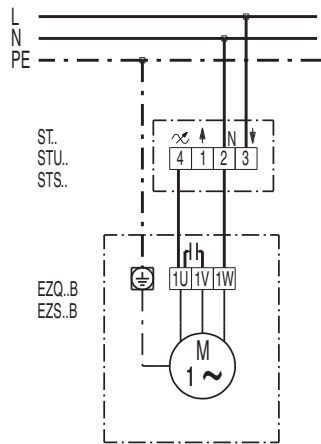

EZS 50/6 B

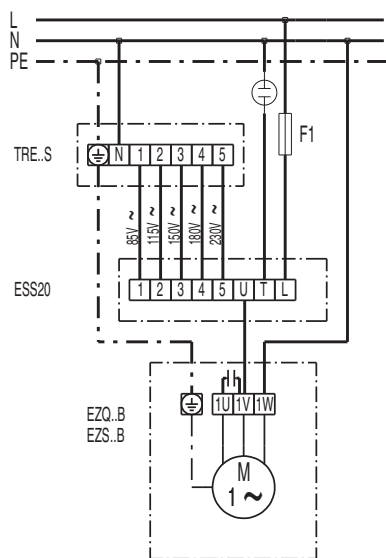
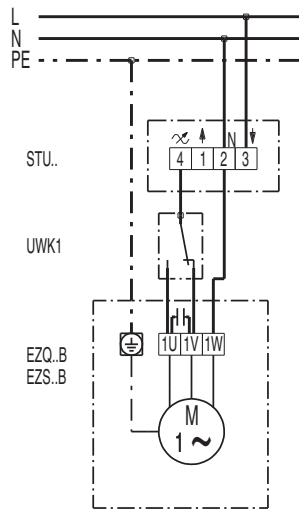

SCHALTBILDER

EZS 50/6 B

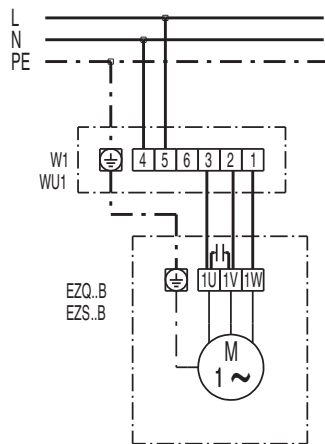
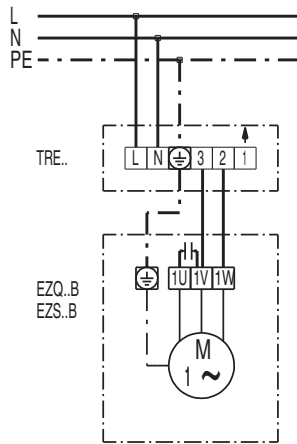

SCHALTBILDER

EZS 50/6 B

