

FLIQ 100.1027.01/DALI

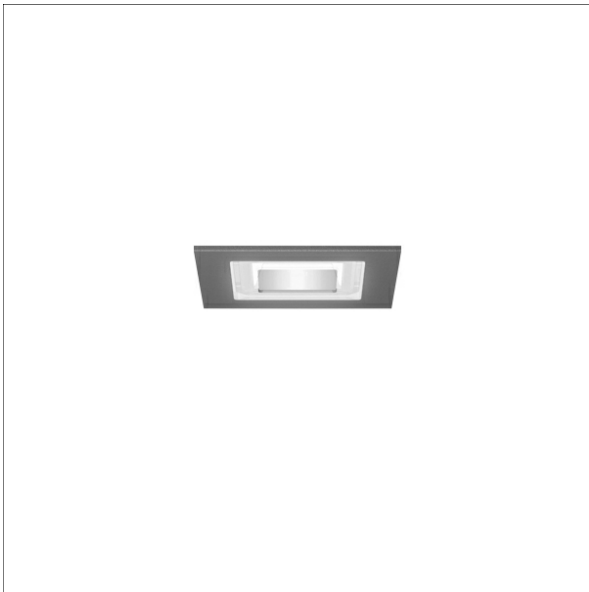

Farbe	Artikelnummer	EAN
schwarz	647588	4043544548221
silber	647589	4043544548238
weiß	647590	4043544548245

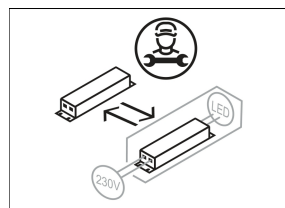
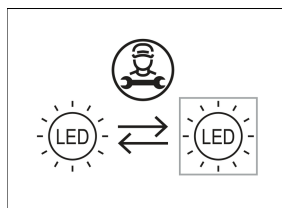
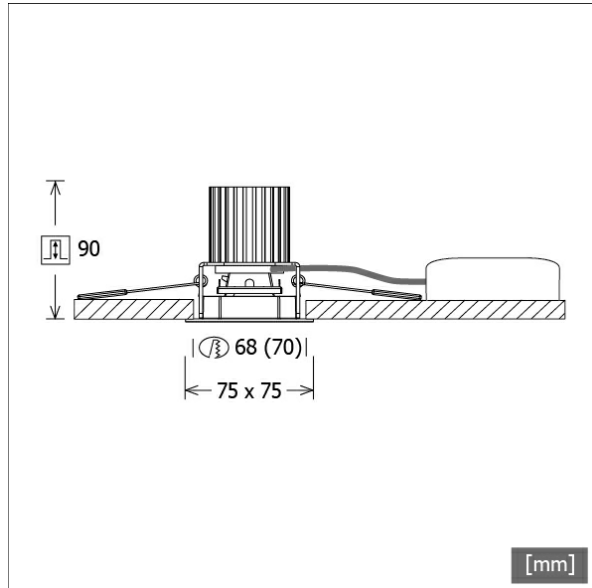

Beschreibung

- Einbau-Downlight mit optischen Designvarianten für Allgemeinbeleuchtung
- hohe Wartungsfreundlichkeit
- keine UV- und Wärmestrahlung
- innovatives Wärmemanagement mit Passivkühlung (Kühlkörper aus Aluminium)
- entspiegelter Mattreflektor aus Aluminium für maximale Lichtausbeute und optimale Entblendung
- Front-/Einbaurahmen aus Zinkdruckguss mit Lichteffektrahmen klar (weitere Dekor-/Lichteffektrahmen und Dekogläser sind als Option erhältlich)
- werkzeugloser Deckeneinbau mit Schnellspannfedern (automatische Anpassung der Deckenstärke)
- Anschluss an Betriebsgerät über Leuchtenkabel mit Mini-Clamp Steckverbindung
- Betriebsgerät (LED-Konverter DALI, dimmbar) inklusive (Platzierung extern)

Hinweise

Das Aussägemeaß = 68 mm gilt nur für Gipskartondecken. Für andere Deckenarten gilt das Aussägemeaß = 70 mm.

Standardoptionen

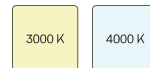

Sonderoptionen



Lichttechnik / Normen

Leuchtmittel	LED Spot / CRI 80 / max. 2700 K
Lebensdauer	L90 B50 50.000 h L80 B50 100.000 h L80 B20 50.000 h
Systemleistung	15,0 W
Leuchten-Lichtstrom	max. 1110 lm
Systemeffizienz	70,66 lm/W
Moduleffizienz	128,00 lm/W
UGR 4H/8H 70/50/20	29,6/29,7 (C0/C90)
Abstrahlwinkel	65°
Versorgungsspannung	220 - 240 V / 50 Hz
Schutzklasse	III
Schutzart	IP20

Abmessungen / Gewichte

Länge	75 mm
Breite	75 mm
Höhe	92 mm
Ausschnittsmaß (∅)	68 mm
Deckenstärke	1 - 25 mm
Einbautiefe	90 mm
Nettogewicht	0,54 kg
Bruttogewicht	0,57 kg

FLIQ 100.1027.01/DALI

FLIQ 100.1027.01/DALI

Flixx 100 Square (FLIQZ 100.25, 1xLED 15W 827/2700K 1060lm 65 °)

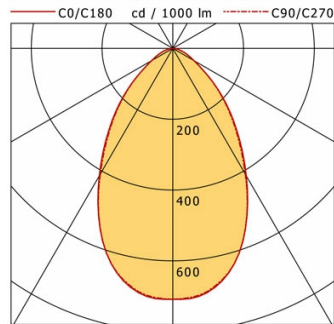

	C0	C90	C180	C270
0°	709	709	709	709
15°	643	642	643	642
30°	416	410	416	410
45°	205	201	205	201
60°	69	68	69	68
75°	24	24	24	24
90°	0	0	0	0

cd / 1000 lm

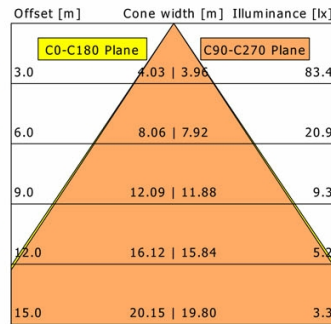

η	LED
Efficiency	71 lm/W
Direct/Indirect	↓ 100% / ↑ 0%
System Power	15 W
UGR	X=4H, Y=8H
Reflection factors	70/50/20
UGR C0/C180	29.6
UGR C90/C270	29.7
CIE Flux Codes	71 92 99 100 100
Ra/CRI	>80

LTS

FLIQ 100.1027.01/DALI

Flixx 100 Square (FLIQZ 100.24, 1xLED 15W 827/2700K 960lm 65 °)

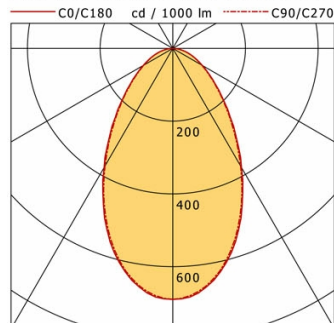

	C0	C90	C180	C270
0°	690	690	690	690
15°	596	591	596	591
30°	378	374	378	374
45°	194	191	194	191
60°	94	92	94	92
75°	39	37	39	37
90°	1	1	1	1

cd / 1000 lm

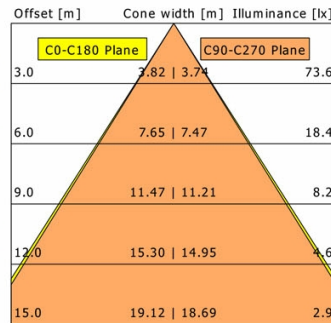

η	LED
Efficiency	64 lm/W
Direct/Indirect	↓ 100% / ↑ 0%
System Power	15 W
UGR	X=4H, Y=8H
Reflection factors	70/50/20
UGR C0/C180	31.4
UGR C90/C270	31.3
CIE Flux Codes	65 88 97 100 100
Ra/CRI	>80

LTS

FLIQ 100.1027.01/DALI

Flixx 100 Square (FLIQZ 100.05, 1xLED 15W 827/2700K 1110lm 65 °)

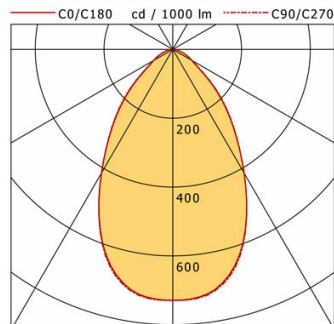

	C0	C90	C180	C270
0°	729	729	729	729
15°	666	670	666	670
30°	415	415	415	415
45°	193	199	193	199
60°	64	65	64	65
75°	23	24	23	24
90°	0	0	0	0

cd / 1000 lm

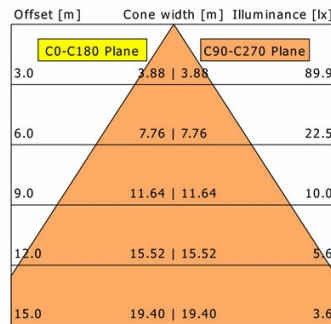

η	LED
Efficiency	74 lm/W
Direct/Indirect	↓ 100% / ↑ 0%
System Power	15 W
UGR	X=4H, Y=8H
Reflection factors	70/50/20
UGR C0/C180	29.4
UGR C90/C270	29.6
CIE Flux Codes	73 93 99 100 100
Ra/CRI	>80

LTS

FLIQ 100.1027.01/DALI

Zubehör



FLIQ 100.01
Dekorrahmen schwarz



FLIQ 100.02
Dekorrahmen silber



FLIQ 100.03
Dekorrahmen weiß



FLIQ 100.04
Lichteffektrahmen opal



FLIQ 100.05
Lichteffektrahmen klar



FLIQ 100.06
Lichteffektrahmen rot matt



FLIQ 100.07
Lichteffektrahmen gelb matt



FLIQ 100.08
Lichteffektrahmen blau matt



FLIQ 100.16
Lichteffektrahmen rot transluzent



FLIQ 100.17
Lichteffektrahmen gelb transluzent



FLIQ 100.18
Lichteffektrahmen blau transluzent



FLIQ 100.24
Dekoglas opal



FLIQ 100.25
Dekoglas klar