

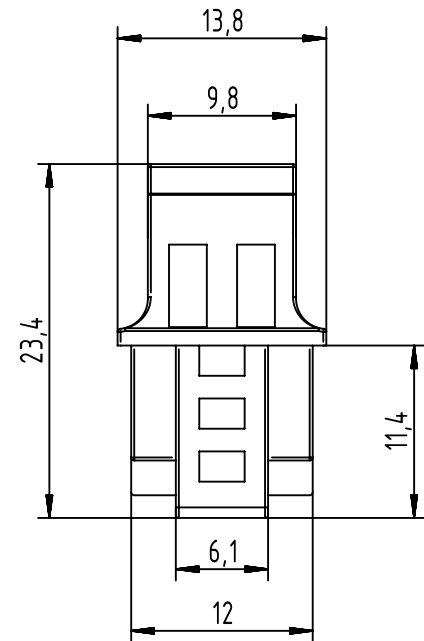

1 2 3 4 5 6

A
B
C
D

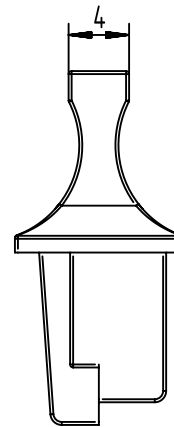
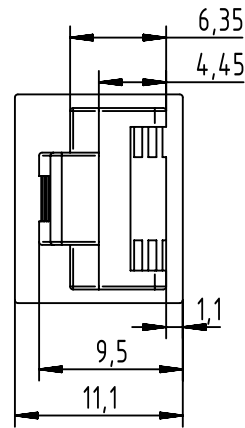
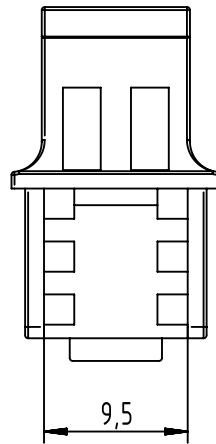
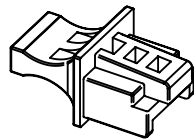
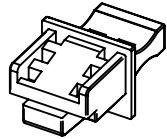

09458520001
Part number

	All rights reserved		Scale 2:1		Free size tol.		Ref.		
	Department EC PD - FR		Created by BOURGEOIS		Inspected by BHUTANI		Standardisation HOFFMANN		
HARTING Electronics GmbH		D-32339 Espelkamp		Title RJ45 jack cover black				Date 2014-08-20	
				Type TB				Number 09458520001	
								State Final Release	
								Doc-Key / ECM-Nr. 100591138/UGD/000/A 500000079030	
								Rev. A	
								Page 1/1	