

5

4

3

2

1

D

C

B

A

Hood lower part

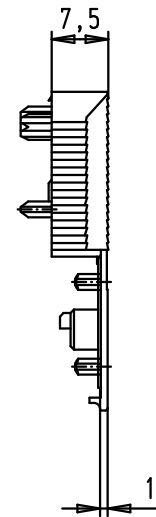
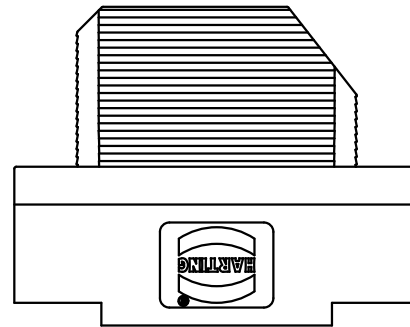
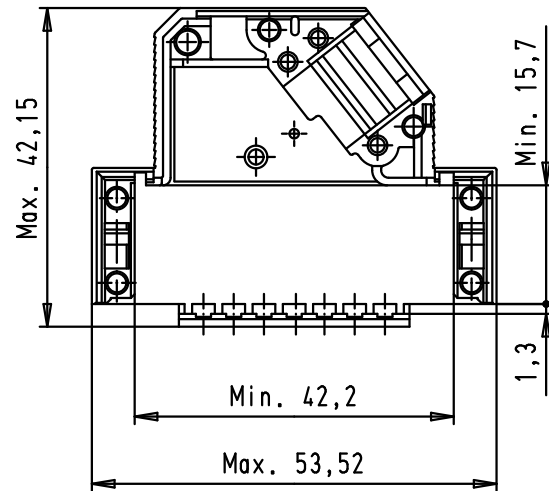
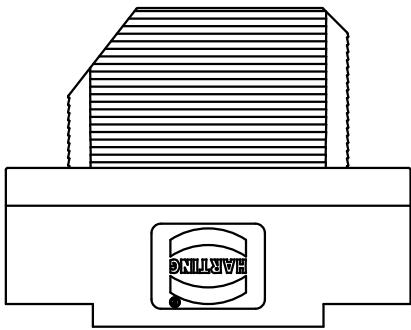

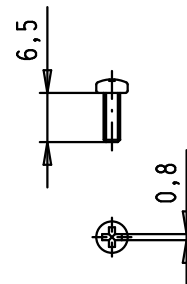
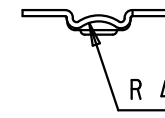
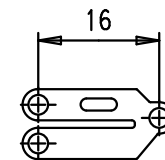
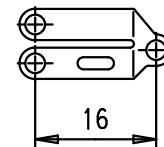
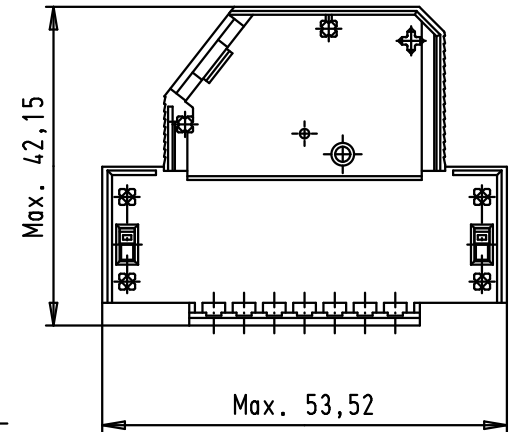

Hood upper part



Strain relief 1

Strain relief 2

Flathead screws

			Dot.	Name	 All Dim. in mm Orig. Size DIN A 4	D-Sub hoods 25 poles not shielded	Maßstab/ Scale 1:1	
			Detail.	27/02/03				SH
ECO1696	20/04/10	SC	Insp.					
34793	09/01/08	PK	Stand.					
33806	26/09/06	PK	HARTING EURL F-95972 Paris				 TB 09 67 025 0571	Blatt/ Page 1 / 1
31392	27/02/03	SH						
Mod.	Dot.	Name					Sub.	