

STRL 607.3370.840/DALI

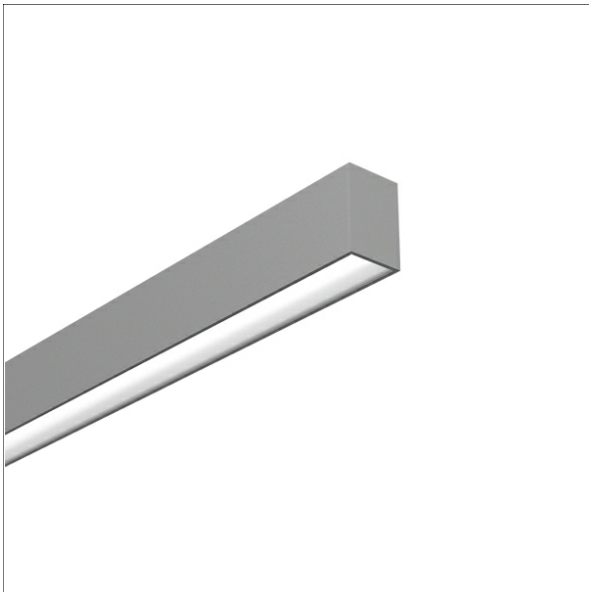

Farbe	Artikelnummer	EAN
silber eloxiert	667745	4043544770929
schwarz	667746	4043544770936
weiß	667747	4043544770943

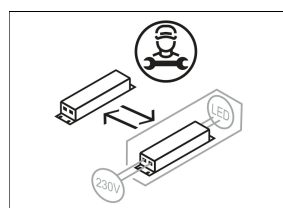
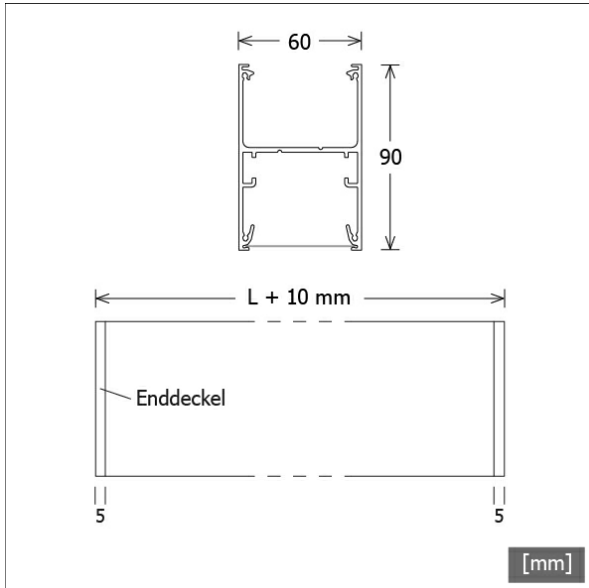

Beschreibung

- Lichtmodul als Fixlänge zur Realisierung von variablen Lichtbandsystemen
- für sehr große Längen geeignet
- hohe Wartungsfreundlichkeit
- keine UV- und Wärmestrahlung
- hochwertiges Aluminiumprofil für Decken- oder Pendelmontage
- integriertes LED-Lichtband mit gewölbtem PMMA-Diffusor für homogene Lichtverteilung
- erforderliche Systemkomponenten separat bestellen
- einschiebbare opale Diffusorfolien in verschiedenen Längen und Abstrahlcharakteristiken
- Montage über Anbauklammern oder Drahtseilabhängung
- steckerfertig für Durchgangsverdrahtung
- Betriebsgerät (LED-Konverter DALI, dimmbar) integriert

Hinweise

Die thermische Längenausdehnung des Aluminiumprofils beträgt bei $dT = 10$ Kelvin 0.3 mm pro Meter.

Standardoptionen



Sonderoptionen



Lichttechnik / Normen

Leuchtmittel	LED linear / CRI 80 / max. 4000 K
Lebensdauer	L90 B50 50.000 h L80 B50 100.000 h L80 B20 50.000 h
Systemleistung	47.3 W
Leuchten-Lichtstrom	max. 5430 lm
Systemeffizienz	100.63 lm/W
Moduleffizienz	164.17 lm/W
UGR 4H/8H 70/50/20	22.7/23.2 (C0/C90)
Versorgungsspannung	220 - 240 V / 50 Hz
Schutzklasse	I
Schutzart	IP20

Abmessungen / Gewichte

Länge	3370 mm
Breite	60 mm
Höhe	90 mm
Nettogewicht	9.33 kg
Bruttogewicht	10.10 kg

STRL 607.3370.840/DALI

STRL 607.3370.840/DALI

StraitLine | Light-Module (Opal Diffuse_si_wh, 1xLED 47W 840/4000K 4760lm)

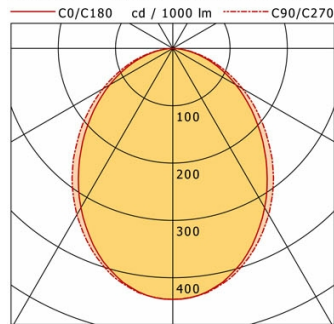

	C0	C90	C180	C270
0°	438	438	438	438
15°	405	410	405	410
30°	321	335	321	335
45°	220	238	220	238
60°	127	141	127	141
75°	51	57	51	57
90°	0	0	0	0
cd / 1000 lm				

Offset [m]	Cone width [m]		Illuminance [lx]
3.0	6.04	6.65	231.5
6.0	12.07	13.30	57.9
9.0	18.11	19.95	25.7
12.0	24.14	26.60	14.5
15.0	30.18	33.26	9.3

η	LED
Efficiency	101 lm/W
Direct/Indirect	↓ 100% / ↑ 0%
System Power	47 W
UGR	X=4H, Y=8H
Reflection factors	70/50/20
UGR C0/C180	22.7
UGR C90/C270	23.2
CIE Flux Codes	53 83 97 100 100
Ra/CRI	>80

LTS

STRL 607.3370.840/DALI

StraitLine | Light-Module (Deep Beam nanoOptix_si_wh, 1xLED 47W 840/4000K 5090lm)

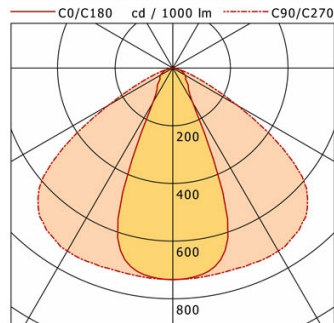

	C0	C90	C180	C270
0°	734	734	734	734
15°	673	730	673	730
30°	138	732	138	732
45°	70	662	70	662
60°	50	260	50	260
75°	23	33	23	33
90°	0	0	0	0
cd / 1000 lm				

Offset [m]	Cone width [m]		Illuminance [lx]
3.0	2.64	9.19	415.0
6.0	5.28	18.38	103.7
9.0	7.92	27.57	46.1
12.0	10.56	36.76	25.9
15.0	13.20	45.95	16.6

η	LED
Efficiency	108 lm/W
Direct/Indirect	↓ 100% / ↑ 0%
System Power	47 W
UGR	X=4H, Y=8H
Reflection factors	70/50/20
UGR C0/C180	16.9
UGR C90/C270	22.3
CIE Flux Codes	71 92 99 100 100
Ra/CRI	>80

LTS

STRL 607.3370.840/DALI

StraitLine | Light-Module (Batwing/Wide Beam nanoOptix_si_wh, 1xLED 47W 840/4000K 5430lm)

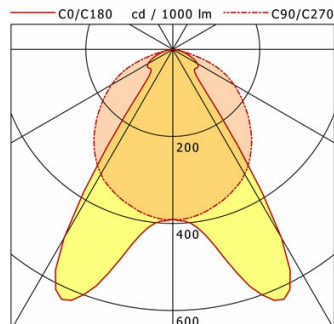

	C0	C90	C180	C270
0°	391	391	391	391
15°	515	373	515	373
30°	500	330	500	330
45°	71	252	71	252
60°	66	163	66	163
75°	25	46	25	46
90°	0	0	0	0
cd / 1000 lm				

Offset [m]	Cone width [m]		Illuminance [lx]
3.0	2.95	4.05	235.7
6.0	7.90	8.12	58.9
9.0	11.85	12.17	26.2
12.0	15.80	16.23	14.7
15.0	19.76	20.29	9.4

η	LED
Efficiency	116 lm/W
Direct/Indirect	↓ 100% / ↑ 0%
System Power	47 W
UGR	X=4H, Y=8H
Reflection factors	70/50/20
UGR C0/C180	18.6
UGR C90/C270	22.6
CIE Flux Codes	66 90 99 100 100
Ra/CRI	>80

LTS

STRL 607.3370.840/DALI

StraitLine | Light-Module (Opal Diffuse_bk, 1xLED 47W 840/4000K 3960lm)

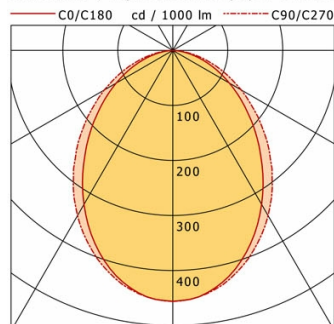

	C0	C90	C180	C270
0°	456	456	456	456
15°	418	424	418	424
30°	323	347	323	347
45°	214	246	214	246
60°	119	144	119	144
75°	45	57	45	57
90°	0	0	0	0
cd / 1000 lm				

Offset [m]	Cone width [m]		Illuminance [lx]
3.0	5.59	6.54	200.6
6.0	11.18	13.07	50.2
9.0	16.77	19.61	22.3
12.0	22.36	26.14	12.5
15.0	27.95	32.68	8.0

η	LED
Efficiency	84 lm/W
Direct/Indirect	↓ 100% / ↑ 0%
System Power	47 W
UGR	X=4H, Y=8H
Reflection factors	70/50/20
UGR C0/C180	21.5
UGR C90/C270	22.5
CIE Flux Codes	54 83 97 100 100
Ra/CRI	>80

LTS

STRL 607.3370.840/DALI

STRL 607.3370.840/DALI

StraitLine | Light-Module (Deep Beam nanoOptix_bk, 1xLED 47W 840/4000K 4470lm)

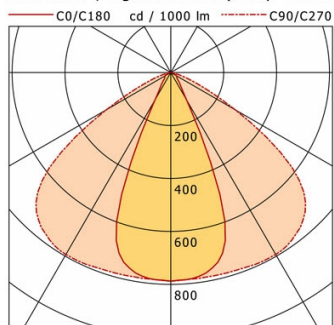

	C0	C90	C180	C270
0°	788	788	788	788
15°	725	786	725	786
30°	118	793	118	793
45°	36	721	36	721
60°	25	282	25	282
75°	9	32	9	32
90°	0	0	0	0

cd / 1000 lm

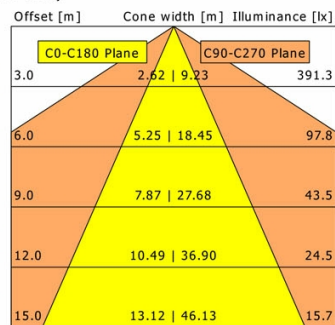

η	LED
Efficiency	95 lm/W
Direct/Indirect	↓ 100% / ↑ 0%
System Power	47 W
UGR	X=4H, Y=8H
Reflection factors	70/50/20
UGR C0/C180	11.4
UGR C90/C270	22.1
CIE Flux Codes	75 94 99 100 100
Ra/CRI	>80

LTS

STRL 607.3370.840/DALI

StraitLine | Light-Module (Batwing/Wide Beam nanoOptix_bk, 1xLED 47W 840/4000K 4680lm)

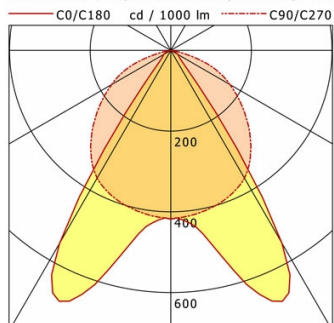

	C0	C90	C180	C270
0°	418	418	418	418
15°	547	402	547	402
30°	552	366	552	366
45°	40	275	40	275
60°	20	169	20	169
75°	7	46	7	46
90°	0	0	0	0

cd / 1000 lm

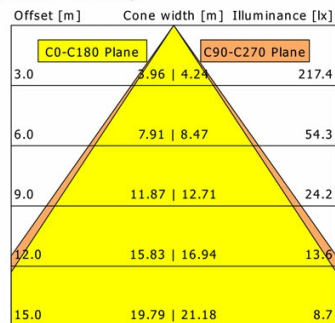

η	LED
Efficiency	100 lm/W
Direct/Indirect	↓ 100% / ↑ 0%
System Power	47 W
UGR	X=4H, Y=8H
Reflection factors	70/50/20
UGR C0/C180	14.1
UGR C90/C270	22.3
CIE Flux Codes	71 94 99 100 100
Ra/CRI	>80

LTS

STRL 607.3370.840/DALI

Zubehör



STRL-LK-Z070-060.102.00
Verbinder-Set linear



STRL-LK060-Z690.BW-WB.03
Lichtlenkungsfolie nanoOptix "Batwing und breitstrahlend"
(Länge: 3 m)



STRL-LK060-Z690.BW-WB.05
Lichtlenkungsfolie nanoOptix "Batwing und breitstrahlend"
(Länge: 5 m)



STRL-LK060-Z690.BW-WB.10
Lichtlenkungsfolie nanoOptix "Batwing und breitstrahlend"
(Länge: 10 m)



STRL-LK060-Z690.BW-WB.15
Lichtlenkungsfolie nanoOptix "Batwing und breitstrahlend"
(Länge: 15 m)



STRL-LK060-Z690.BW-WB.20
Lichtlenkungsfolie nanoOptix "Batwing und breitstrahlend"
(Länge: 20 m)



STRL-LK060-Z690.BW-WB.25
Lichtlenkungsfolie nanoOptix "Batwing und breitstrahlend"
(Länge: 25 m)



STRL-LK060-Z690.BW-WB.30
Lichtlenkungsfolie nanoOptix "Batwing und breitstrahlend"
(Länge: 30 m)



STRL-LK060-Z690.DB.03
Lichtlenkungsfolie nanoOptix "tiefstrahlend"
(Länge: 3 m)



STRL-LK060-Z690.DB.05
Lichtlenkungsfolie nanoOptix "tiefstrahlend"
(Länge: 5 m)



STRL-LK060-Z690.DB.10
Lichtlenkungsfolie nanoOptix "tiefstrahlend"
(Länge: 10 m)



STRL-LK060-Z690.DB.15
Lichtlenkungsfolie nanoOptix "tiefstrahlend"
(Länge: 15 m)



STRL-LK060-Z690.DB.20
Lichtlenkungsfolie nanoOptix "tiefstrahlend"
(Länge: 20 m)



STRL-LK060-Z690.DB.25
Lichtlenkungsfolie nanoOptix "tiefstrahlend"
(Länge: 25 m)



STRL-LK060-Z690.DB.30
Lichtlenkungsfolie nanoOptix "tiefstrahlend"
(Länge: 30 m)



STRL-LK060-Z690.OPDF.03
Lichtlenkungsfolie "opal diffus"
(Länge: 3 m)



STRL-LK060-Z690.OPDF.05
Lichtlenkungsfolie "opal diffus"
(Länge: 5 m)



STRL-LK060-Z690.OPDF.10
Lichtlenkungsfolie "opal diffus"
(Länge: 10 m)

STRL 607.3370.840/DALI

Zubehör



STRL-LK060-Z 690.OPDF.15
Lichtlenkungsfolie "opal diffus"
(Länge: 15 m)



STRL-LK060-Z 690.OPDF.20
Lichtlenkungsfolie "opal diffus"
(Länge: 20 m)



STRL-LK060-Z 690.OPDF.25
Lichtlenkungsfolie "opal diffus"
(Länge: 25 m)



STRL-LK060-Z 690.OPDF.30
Lichtlenkungsfolie "opal diffus"
(Länge: 30 m)



STRL-LKDI-Z 060.001
Enddeckel
(2 Stück)

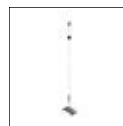

STRL-LKDI-Z 060.104.03
Drahtseil-Set ohne Einspeisung
(Länge: 3000 mm)

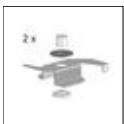

STRL-Z 104
Anbauklammern
(2 Stück)