

SCHALTBILDER

DZR 45/6 B

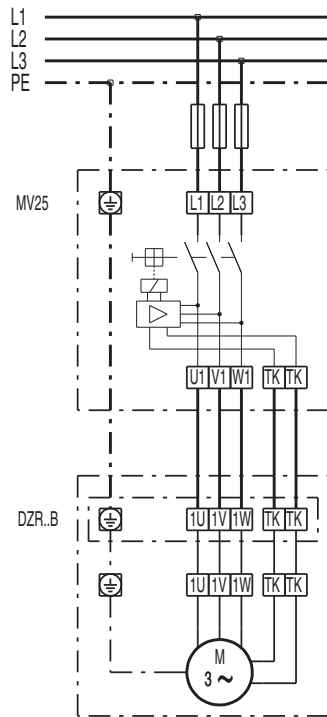

SCHALTBILDER

DZR 45/6 B

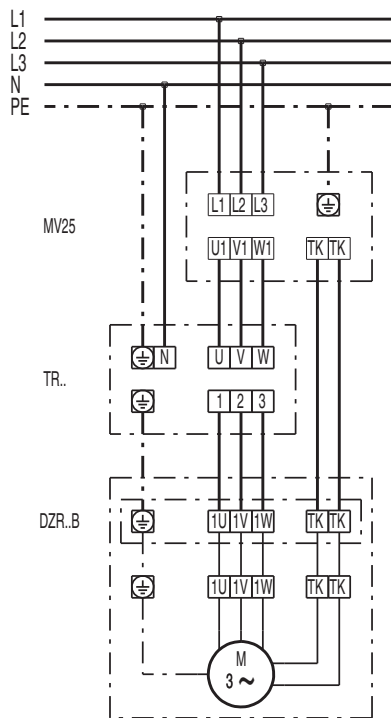

SCHALTBILDER

DZR 45/6 B

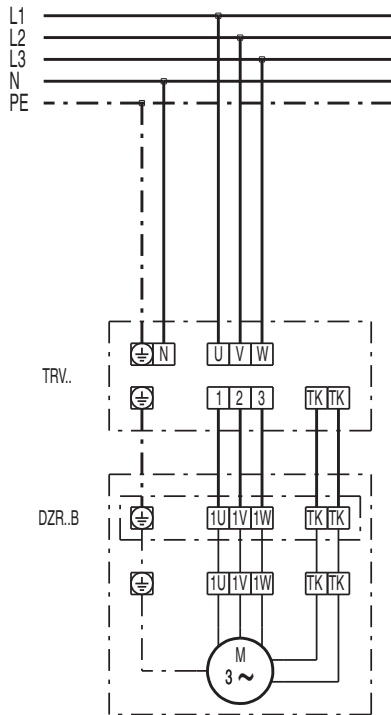

SCHALTBILDER

DZR 45/6 B

