

Panel mounting socket outlet, angled - flange 68x62, fixing centers 47x47



Product description	
BALS-Prd.-Nr	12732
EAN	4024941127325
Product category	Panel mounting socket outlet Quick-Connect, angled
Current	16A
Number of poles	3p
Poles	2P+PE
Position of earth contact	6 h
Voltage	200 up to 250V

Product description	
Frequency	50 and 60Hz
Protection degree	IP44
Colour code	blue RAL 5015
Colour of appliance	Hinged lid blue RAL 5015, Enclosure grey RAL 7035
Connection design	screwless spring terminals as cage clamp with Kontex-contact
Maximum conductor size	4,0 qmm
Cable entry	other
Height	75mm
Width	62mm
Depth	90mm
Flange size vertical	68mm
Flange size horizontal	62mm
Drill hole distance vertical	47mm
Drill hole distance horizontal	47mm
Material of enclosure	Polyamide
Contact	The contact carrier is made of polyamide, The contacts are brass

Additional technical properties	
	The inclination is 20°

Logistics data	
Weight/pcs	0.106 kg / Piece
Packaging	Bag
Content amount	1 ST
EAN	4024941127325
Length	90 mm
Width	62 mm
Height	75 mm
Weight	0.107 kg
Volume	418.5 ccm
Packaging	Carton
Content amount	10 ST
EAN	4024941820769
Length	207 mm
Width	162 mm
Height	142 mm
Weight	1.16 kg
Volume	3,750 ccm

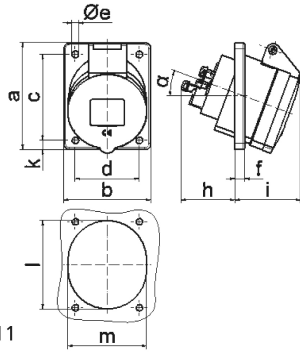

4 MB 111

Ampere	16	16	16			
Polzahl	3	4	5			
a	68,0	87,0	87,0			
b	62,0	71,0	71,0			
c	47,0	70,0	70,0			
d	47,0	52,0	52,0			
e Ø	5,5	5,5	5,5			
f	8,0	5,5	5,5			
h	46,0	46,0	46,0			
i	50,0	54,0	54,0			
k	-	9,5	9,5			
l	56,0	65,0	72,0			
m	51,0	58,0	64,0			
α	20°	20°	20°			
Leiter mm ² min	1,5	1,5	1,5			
Leiter mm ² max	4	4	4			