

## PANEL PERFORMANCE 600/625 DALI

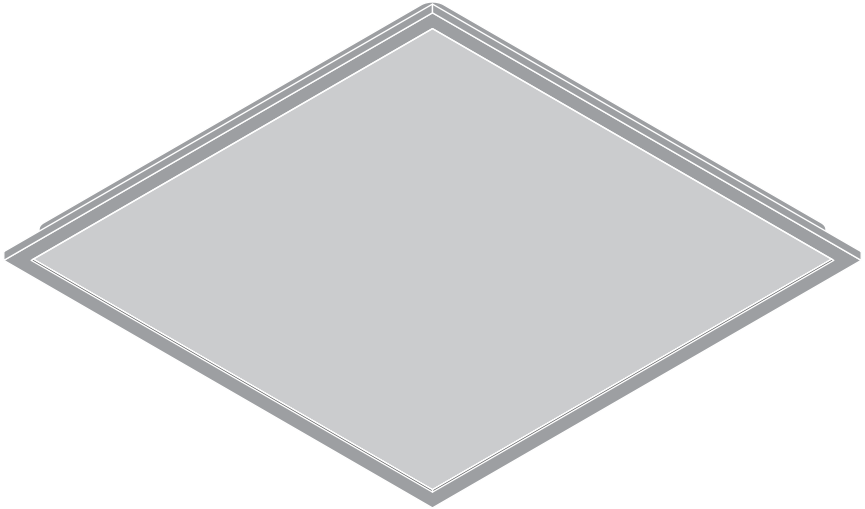

	EAN	l x w x h [mm]	W	**EM W (230VDC)	VAC	Hz	lm	lm/W	**EM lm (230VDC)
PL PFM 600 DALI 30W/3000K	4058075537972	595 x 595 x 32	30	6	220-240	0/50/60	3600	120	600
PL PFM 600 DALI 30W/4000K	4058075538030	595 x 595 x 32	30	6	220-240	0/50/60	3600	120	600
PL PFM 600 DALI 30W/3000K UGR<19	4058075538085	595 x 595 x 32	30	6	220-240	0/50/60	3600	120	600
PL PFM 600 DALI 30W/4000K UGR<19	4058075538122	595 x 595 x 32	30	6	220-240	0/50/60	3600	120	600
PL PFM 600 DALI 36W/3000K	4058075440357	595 x 595 x 35	36	6.5	220-240	0/50/60	4320	120	600
PL PFM 600 DALI 36W/4000K	4058075440395	595 x 595 x 35	36	6.5	220-240	0/50/60	4320	120	600
PL PFM 600 DALI 36W/3000K UGR19	4058075440456	595 x 595 x 35	36	6.5	220-240	0/50/60	4320	120	600
PL PFM 600 DALI 36W/4000K UGR19	4058075440470	595 x 595 x 35	36	6.5	220-240	0/50/60	4320	120	600
PL PFM 600 36W/940 UGR19 DALI	4058075521988	595 x 595 x 32	36	6.5	220-240	0/50/60	3750	105	550
PL PFM 625 DALI 30W/3000K	4058075538160	620 x 620 x 32	30	6	220-240	0/50/60	3600	120	600
PL PFM 625 DALI 30W/4000K	4058075538191	620 x 620 x 32	30	6	220-240	0/50/60	3600	120	600
PL PFM 625 DALI 30W 3000K/UGR<19	4058075538221	620 x 620 x 32	30	6	220-240	0/50/60	3600	120	600
PL PFM 625 DALI 30W/4000K UGR<19	4058075538252	620 x 620 x 32	30	6	220-240	0/50/60	3600	120	600
PL PFM 625 DALI 36W/3000K	4058075440616	620 x 620 x 35	36	6.5	220-240	0/50/60	4320	120	600
PL PFM 625 DALI 36W/4000K	4058075440654	620 x 620 x 35	36	6.5	220-240	0/50/60	4320	120	600
PL PFM 625 DALI 36W/3000K UGR19	4058075440753	620 x 620 x 35	36	6.5	220-240	0/50/60	4320	120	600
PL PFM 625 DALI 36W/4000K UGR19	4058075440777	620 x 620 x 35	36	6.5	220-240	0/50/60	4320	120	600

	EAN	Φuse (lm)	K	IP	∇	R <sub>a</sub>	⊖ (°C)	PF	👤
PL PFM 600 DALI 30W/3000K	4058075537972	3600	3000	40/20	120°	>80	-10...+50	>0.95	1.7 kg
PL PFM 600 DALI 30W/4000K	4058075538030	3600	4000	40/20	120°	>80	-10...+50	>0.95	1.7 kg
PL PFM 600 DALI 30W/3000K UGR<19	4058075538085	3100	3000	40/20	90°	>80	-10...+50	>0.95	2.0 kg
PL PFM 600 DALI 30W/4000K UGR<19	4058075538122	3100	4000	40/20	90°	>80	-10...+50	>0.95	2.0 kg
PL PFM 600 DALI 36W/3000K	4058075440357	4320	3000	40/20	120°	>80	-10...+50	>0.95	1.8 kg
PL PFM 600 DALI 36W/4000K	4058075440395	4320	4000	40/20	120°	>80	-10...+50	>0.95	1.8 kg
PL PFM 600 DALI 36W/3000K UGR19	4058075440456	3700	3000	40/20	90°	>80	-10...+50	>0.95	2.0 kg
PL PFM 600 DALI 36W/4000K UGR19	4058075440470	3700	4000	40/20	90°	>80	-10...+50	>0.95	2.0 kg
PL PFM 600 36W/940 UGR19 DALI	4058075521988	3150	4000	40/20	90°	>90	-10...+50	>0.95	2.0 kg
PL PFM 625 DALI 30W/3000K	4058075538160	3600	3000	40/20	120°	>80	-10...+50	>0.95	1.9 kg
PL PFM 625 DALI 30W/4000K	4058075538191	3600	4000	40/20	120°	>80	-10...+50	>0.95	1.9 kg
PL PFM 625 DALI 30W 3000K/UGR<19	4058075538221	3100	3000	40/20	90°	>80	-10...+50	>0.95	2.2 kg
PL PFM 625 DALI 30W/4000K UGR<19	4058075538252	3100	4000	40/20	90°	>80	-10...+50	>0.95	2.2 kg
PL PFM 625 DALI 36W/3000K	4058075440616	4320	3000	40/20	120°	>80	-10...+50	>0.95	1.9 kg
PL PFM 625 DALI 36W/4000K	4058075440654	4320	4000	40/20	120°	>80	-10...+50	>0.95	1.9 kg
PL PFM 625 DALI 36W/3000K UGR19	4058075440753	3700	3000	40/20	90°	>80	-10...+50	>0.95	2.2 kg
PL PFM 625 DALI 36W/4000K UGR19	4058075440777	3700	4000	40/20	90°	>80	-10...+50	>0.95	2.2 kg

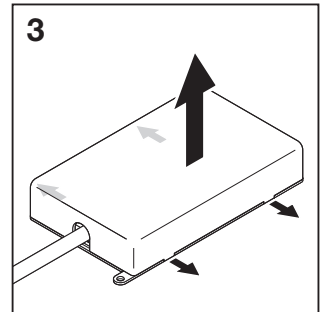
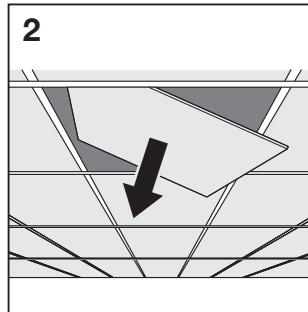
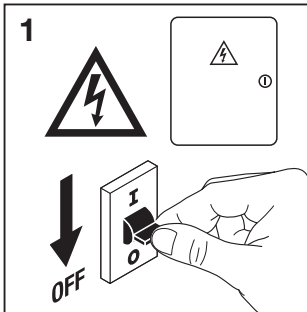
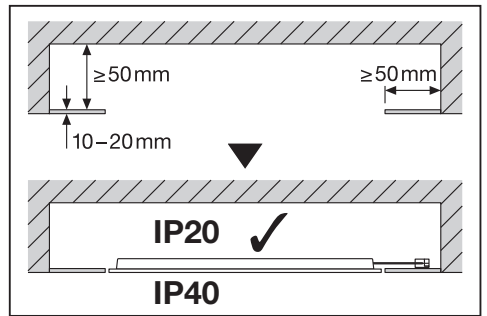
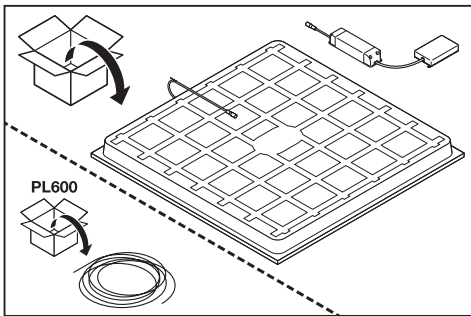

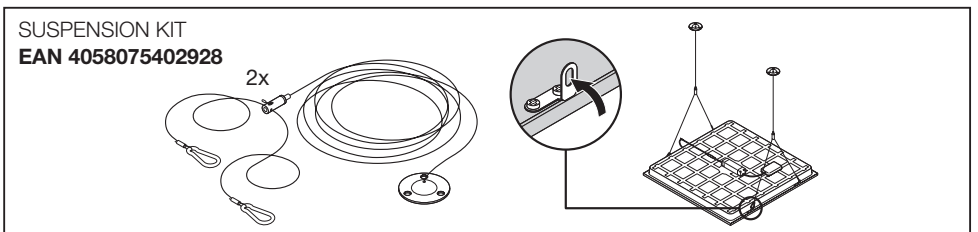
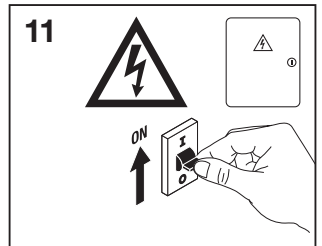
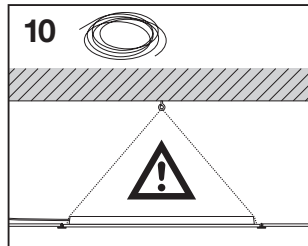
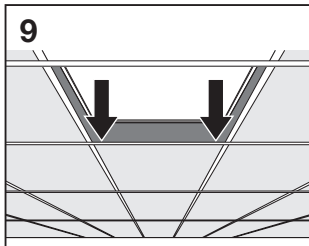
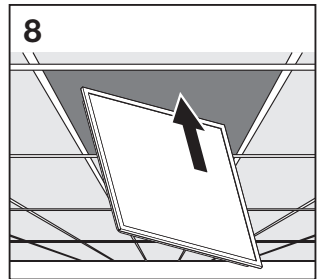
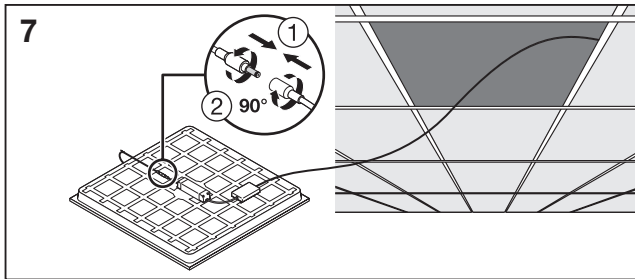
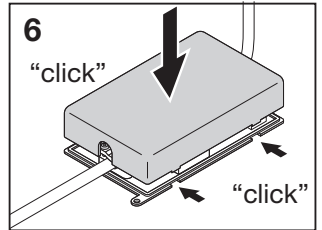
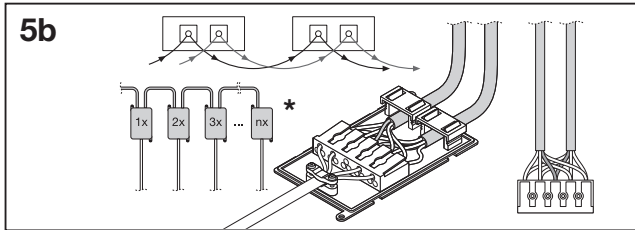
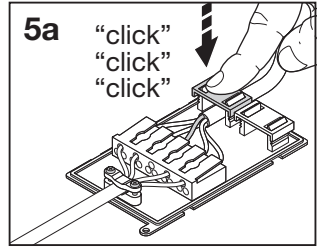
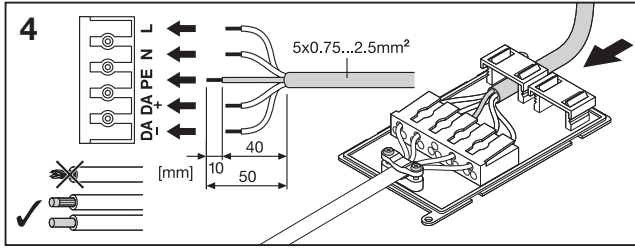

# RECESSED MOUNT CLIPS VALUE

EAN 4058075409859

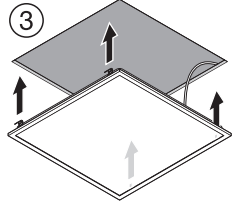
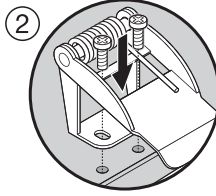
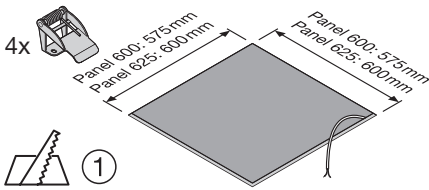

PL 600 SURFACE MOUNT KIT H75

EAN 4058075472914

PL 625 SURFACE MOUNT KIT H75

EAN 4058075472938

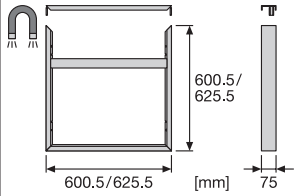

PL 600 SURFACE MOUNT KIT H70 VAL

EAN 4058075402843

PL 625 SURFACE MOUNT KIT H70 VAL

EAN 4058075402867

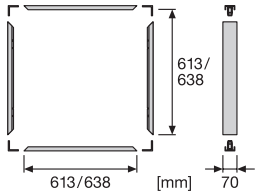

PL 600 RECESSED MOUNT FRAME

EAN 4058075402881

PL 625 RECESSED MOUNT FRAME

EAN 4058075402904

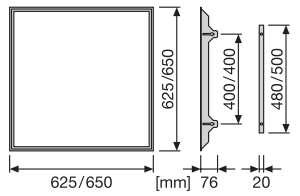

	*C*10A	*B*16A	*C*16A		DALI	IOUT [mA]	DIM
<b>PANEL PFM 30W DALI</b>	n=21	n=20	n=33		OSRAM OTi DALI 50/220...240/1A4 NFC	660	✓
<b>PANEL PFM 36W DALI</b>	n=21	n=20	n=33		OSRAM OTi DALI 50/220...240/1A4 NFC	760	✓

\*\* Ⓞ Leuchten mit zusätzlichen Notstrom Anforderungen gemäß EN 60598-2-22 zertifiziert (gilt nicht für Frankreich und Dänemark). Ⓞ Luminaires certified including the additional emergency requirements of EN 60598-2-22 (not applicable for France and Denmark). Ⓞ Luminaires homologues conformément aux exigences supplémentaires de la norme EN 60598-2-22 en matière d'éclairage de secours (ne s'applique pas pour la France et le Danemark). Ⓞ Impianti di illuminazione certificati includendo i requisiti aggiuntivi di emergenza di EN 60598-2-22 (non applicabili a Francia e Danimarca). Ⓞ Lámparas certificadas incluyendo los requisitos de emergencia adicionales de EN 60598-2-22 (no aplicable para Francia y Dinamarca). Ⓞ Luminárias certificadas, incluindo os requisitos de emergência adicionais da norma EN 60598-2-22 (não se aplica para França e Dinamarca). Ⓞ Φωτιστικά σώματα πιστοποιημένα περιλαμβανομένων των πρόσθετων απαιτήσεων έκτακτης ανάγκης του EN 60598-2-22 (δεν έχει εφαρμογή για Γαλλία και Δανία). Ⓞ Geocertificeerde lampen die voldoen aan de bijzondere eisen van NBN-EN-IEC 60598-2-22 verlichtingsarmaturen voor noodverlichting (geldt niet voor Frankrijk en Denemarken). Ⓞ Ljussarmaturerna är certifierade inklusive Nödbelysningskraven i EN 60598-2-22 (ej tillämpligt för Frankrike och Danmark). Ⓞ Valaisimet on sertifioitu EN 60598-2-22 -normin turvalisaisia koskevien lisämääräysten mukaan (ei koske Ranskaa ja Tanskaa). Ⓞ Armaturer certifieret med ekstra nødkrav iht. EN 60598-2-22 (gælder ikke for Frankrig og Danmark). Ⓞ Světla certifikovaná s dodatečnými požadavky na nouzovou proud podle normy EN 60598-2-22 (neplatí pro Francii a Dánsko). Ⓞ Светильники сертифицированы с учетом дополнительных аварийных требований стандарта EN 60598-2-22 (не применимо для Франции и Дании). Ⓞ A lámpatestek az EN 60598-2-22 szabvány kiegészítő vészhelyzeti előírásait is figyelembe véve tanúsítottak (Franciaország és Dánia esetén nem érvényes). Ⓞ Oprawy oświetleniowe z certyfikatem potwierdzającym spełnienie dodatkowych wymagań dotyczących oświetlenia awaryjnego zgodnie z normą EN 60598-2-22 (nie dotyczy Francji i Danii). Ⓞ Certifikované světelné tělárky včetně dodatečných náročných požadaviek normy EN 60598-2-22 (neplatí pre Francúzsko a Dánsko). Ⓞ Svetilke z dodatnimi zahtevami glede napajanja v sili, certificirane v skladu z EN 60598-2-22 (ne velja za Francijo in Dansko). Ⓞ EN 60598-2-22 sayılı standartın ek acil gerekliliklerini içeren sertifikalı armatürler (Fransa ve Danimarka için geçerli değildir). Ⓞ Certificirana rasvjetna tijela uključujući dodatne zahtjeve u slučaju opasnosti sukladno normi EN 60598-2-22 (nije primjenjivo za Francusku i Dansku). Ⓞ Corpuri de iluminat certificate inclusiv pentru cerințele suplimentare de urgență din EN 60598-2-22 (neaplicabil pentru Franța și Danemarca). Ⓞ Осветителни тела, сертифицирани включително съгласно допълнителните изисквания за аварийно осветление по EN 60598-2-22 (не се отнася за Франция и Дания). Ⓞ Valgustid, mis on sertifitseeritud muuhulgas vastavalt standardiga EN 60598-2-22 kehtestatud hädaolukustuse erinõude osas (ei kehti Prantsusmaal ja Taanis korral). Ⓞ Sviestvalit serifikuoti, įskaitant papildomus išskirtinius reikalavimus pagal EN 60598-2-22 (netaikoma Prancūzijoje ir Danijoje). Ⓞ Gaismeki serifikēti, tostarp iekšējajot EN 60598-2-22 papildu ārkārtas prasības (neattiecas uz Franciju un Dāniju). Ⓞ Сертификоване светилке, uključujući i dodatne zahtjeve za hitne slučajeve u skladu sa EN 60598-2-22 (ne važi za Francusku i Dansku). Ⓞ Світільники сертифіковані з урахуванням додаткових вимог щодо світільників для аварійного освітлення згідно зі стандартом EN 60598-2-22 (не діє для Франції та Данії). Ⓞ Бул шандалдар EN 60598-2-22 стандартының қосымша тегінен талаптарына сай сертификатталған (Франция мен Дания үшін қолданылмаиды).



C10449057  
G11104537V2  
18.01.21



LEDVANCE GmbH  
Steinerne Furt 62  
86167 Augsburg, Germany  
www.ledvance.com