

Plug - with TE screw terminals, for harsh applications



Product description	
BALS-Prd.-Nr	2190
EAN	4024941021906
Product category	TE plug
Current	125A
Number of poles	3p
Poles	2P+PE
Position of earth contact	4 h
Voltage	100 up to 130V
Frequency	50 and 60Hz

Product description	
Protection degree	IP67
Colour code	yellow RAL 1012
Colour of appliance	Collar yellow RAL 1012, Pusher grey RAL 7035, Housing cover grey RAL 7035, Cable gland grey RAL 7035
Connection design	screw terminal as box terminal
Maximum conductor size	50.0 qmm
Cable entry	Cable gland
Height	273mm
Width	126mm
Depth	126mm
Material of enclosure	Polyamide
Contact	The contact carrier is made of high temperature resistant material, the contacts are brass nickel plated

Additional technical properties	
	For cable diameter from 26 up to max. 50 mm, Screwless housing connection, Multi-Grip cable gland with gasket, integrated cable clamp and additional water evacuation openings

Logistics data	
Weight/pcs	1.02 kg / Piece
Packaging	Bag
Content amount	1 ST

Logistics data	
EAN	4024941021906
Length	126 mm
Width	126 mm
Height	273 mm
Weight	1.021 kg
Volume	4,334.148 ccm
Packaging	Carton
Content amount	5 ST
EAN	4024941818728
Length	345 mm
Width	345 mm
Height	217 mm
Weight	5.435 kg
Volume	24,276 ccm

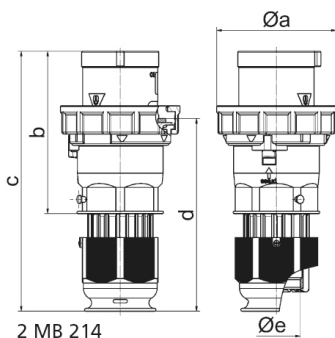

Ampere	125	125	125				
Polzahl	3	4	5				
a ø	126,0	126,0	126,0				
b	181,0	181,0	181,0				
c	282,0	282,0	282,0				
d	206,0	206,0	206,0				
e ø	50,0	50,0	50,0				
Leiter mm ² min	16	16	16				
Leiter mm ² max	50	50	50				