



Maßzeichnungen Instafix® BKI Installationskanal

Artikelnummer: IFAK260100w

Instafix® BKI Abschlusskappe 260 x 100 mm, reinweiß
GTIN 4251636715646

Maßzeichnungen:

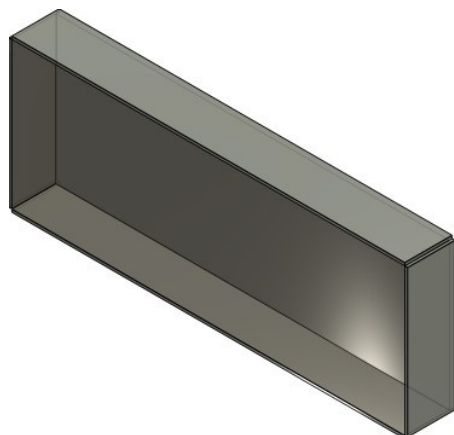
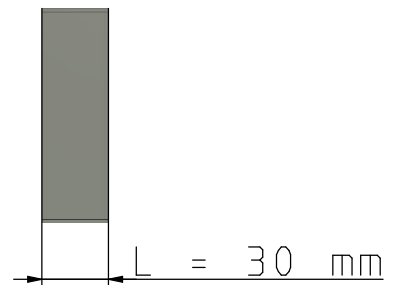
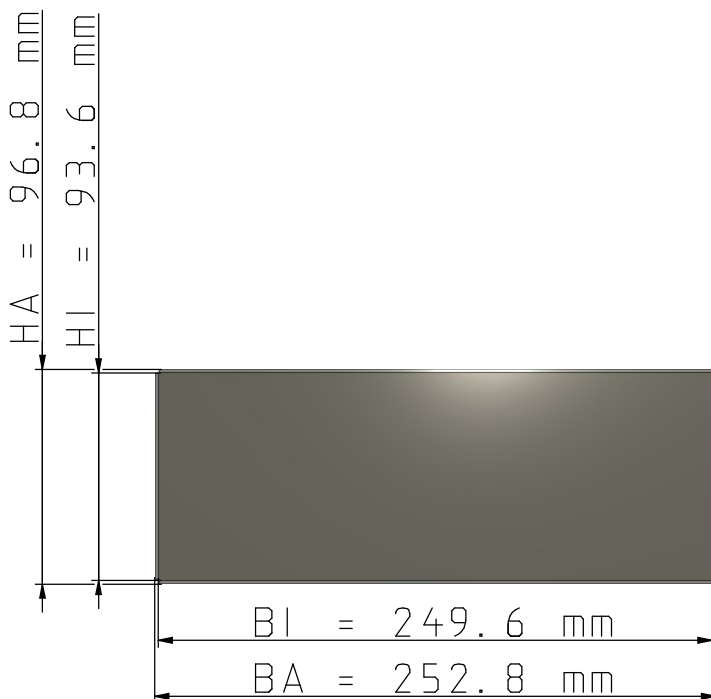

Einfach. Sicher. Für alle.

Wichmann Brandschutzsysteme GmbH & Co. KG • Siemensstraße 7 • 57439 Attendorn

Telefon: 02722 6382-0 • Telefax: 02722 6382-299 • E-Mail: info@wichmann.biz • www.wichmann.biz