

SCHALTBILDER

DZR 30/42 B

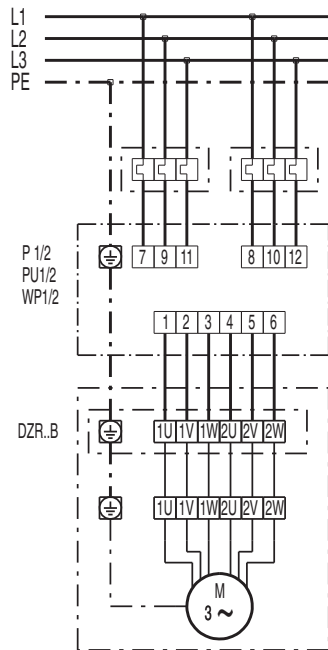

SCHALTBILDER

DZR 30/42 B

