

SCHALTBILDER

DZR 25/84 B

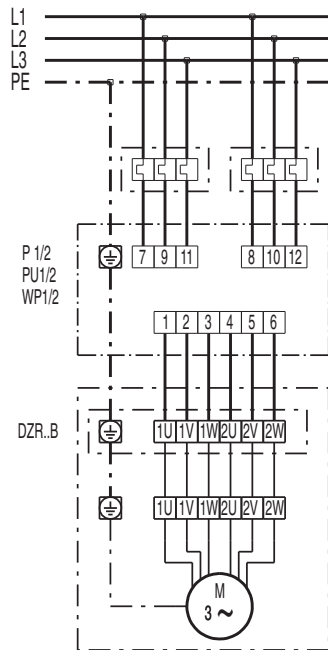

SCHALTBILDER

DZR 25/84 B

