

FLIQ 100.1030.01/DALI

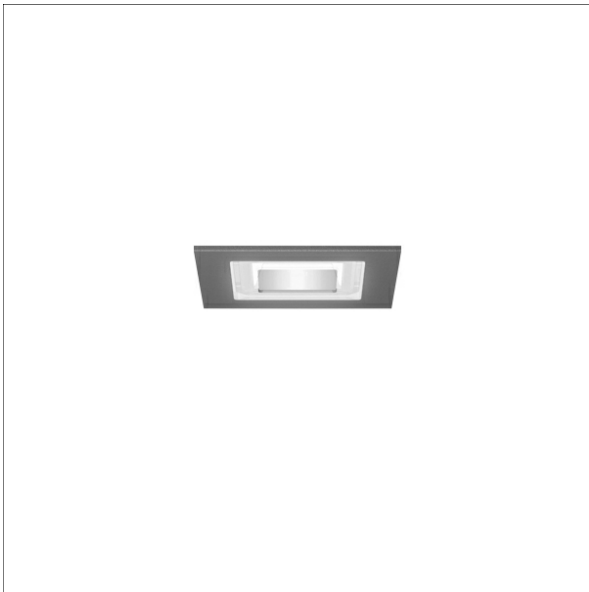

Farbe	Artikelnummer	EAN
schwarz	636417	4043544389978
silber	636418	4043544389985
weiß	636419	4043544389992

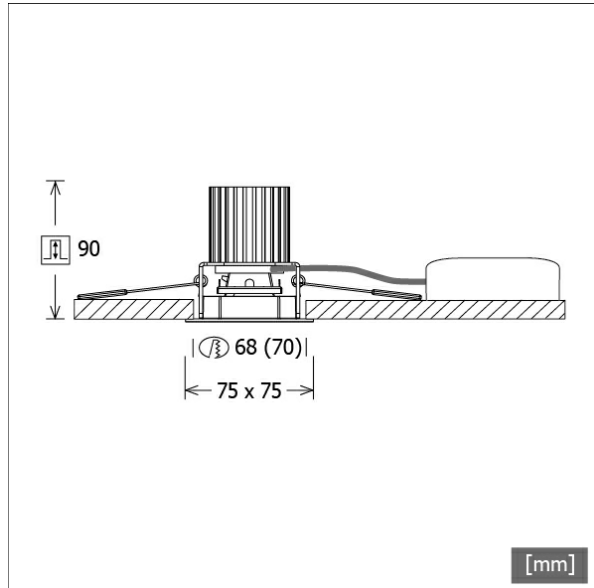

Beschreibung

- Einbau-Downlight mit optischen Designvarianten für Allgemeinbeleuchtung
- hohe Wartungsfreundlichkeit
- keine UV- und Wärmestrahlung
- innovatives Wärmemanagement mit Passivkühlung (Kühlkörper aus Aluminium)
- entspiegelter Mattreflektor aus Aluminium für maximale Lichtausbeute und optimale Entblendung
- Front-/Einbaurahmen aus Zinkdruckguss mit Lichteckrahmen klar (weitere Dekor-/Lichteckrahmen und Dekogläser sind als Option erhältlich)
- werkzeugloser Deckeneinbau mit Schnellspannfedern (automatische Anpassung der Deckenstärke)
- Anschluss an Betriebsgerät über Leuchtenkabel mit Mini-Clamp Steckverbindung
- Betriebsgerät (LED-Konverter DALI, dimmbar) inklusive (Platzierung extern)

Hinweise

Das Aussägemeaß = 68 mm gilt nur für Gipskartondecken. Für andere Deckenarten gilt das Aussägemeaß = 70 mm.

Standardoptionen

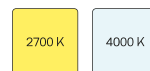

Sonderoptionen



Lichttechnik / Normen

Leuchtmittel	LED Spot / CRI 80 / max. 3000 K
Lebensdauer	L90 B50 50.000 h L80 B50 100.000 h L80 B20 50.000 h
Systemleistung	15,0 W
Leuchten-Lichtstrom	max. 1160 lm
Systemeffizienz	77,33 lm/W
Moduleffizienz	134,00 lm/W
UGR 4H/8H 70/50/20	29,6/29,8 (C0/C90)
Abstrahlwinkel	65°
Versorgungsspannung	220 - 240 V / 50 Hz
Schutzklasse	III
Schutzart	IP20

Abmessungen / Gewichte

Länge	75 mm
Breite	75 mm
Höhe	92 mm
Ausschnittsmaß (∅)	68 mm
Deckenstärke	1 - 25 mm
Einbautiefe	90 mm
Nettogewicht	0,54 kg
Bruttogewicht	0,57 kg

FLIQ 100.1030.01/DALI

FLIQ 100.1030.01/DALI

Flixx 100 Square (FLIQZ 100.05, 1xLED 15W 830/3000K 1160lm 65 °)

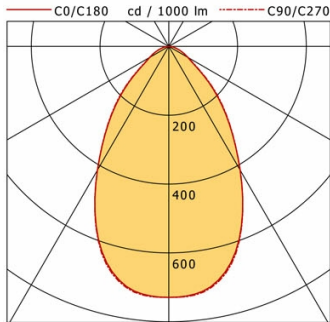

	C0	C90	C180	C270
0°	729	729	729	729
15°	666	670	666	670
30°	415	415	415	415
45°	193	199	193	199
60°	64	65	64	65
75°	23	24	23	24
90°	0	0	0	0

cd / 1000 lm

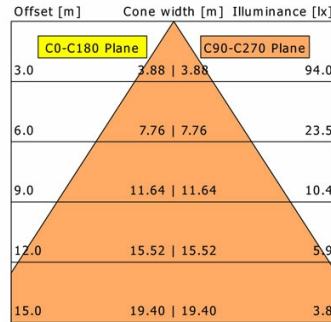

η	LED
Efficiency	77 lm/W
Direct/Indirect	↓ 100% / ↑ 0%
System Power	15 W
UGR	X=4H, Y=8H
Reflection factors	70/50/20
UGR C0/C180	29.6
UGR C90/C270	29.8
CIE Flux Codes	73 93 99 100 100
Ra/CRI	>80

LTS

FLIQ 100.1030.01/DALI

Flixx 100 Square (FLIQZ 100.25, 1xLED 15W 830/3000K 1110lm 65 °)

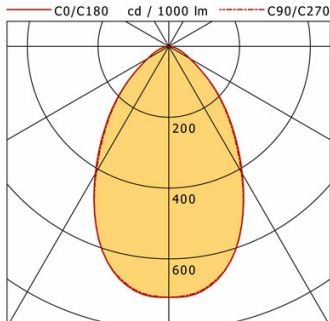

	C0	C90	C180	C270
0°	709	709	709	709
15°	643	642	643	642
30°	416	410	416	410
45°	205	201	205	201
60°	69	68	69	68
75°	24	24	24	24
90°	0	0	0	0

cd / 1000 lm

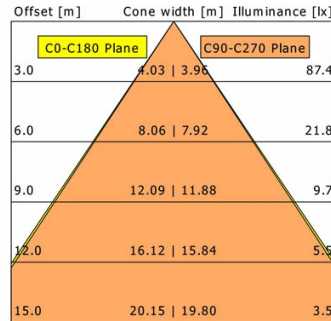

η	LED
Efficiency	74 lm/W
Direct/Indirect	↓ 100% / ↑ 0%
System Power	15 W
UGR	X=4H, Y=8H
Reflection factors	70/50/20
UGR C0/C180	29.7
UGR C90/C270	29.8
CIE Flux Codes	71 92 99 100 100
Ra/CRI	>80

LTS

FLIQ 100.1030.01/DALI

Flixx 100 Square (FLIQZ 100.24, 1xLED 15W 830/3000K 1010lm 65 °)

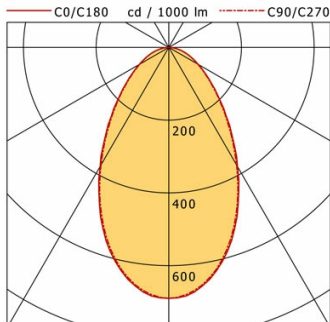

	C0	C90	C180	C270
0°	690	690	690	690
15°	596	591	596	591
30°	378	374	378	374
45°	194	191	194	191
60°	94	92	94	92
75°	39	37	39	37
90°	1	1	1	1

cd / 1000 lm

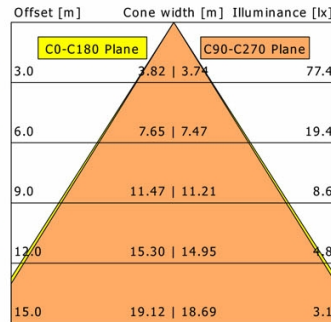

η	LED
Efficiency	67 lm/W
Direct/Indirect	↓ 100% / ↑ 0%
System Power	15 W
UGR	X=4H, Y=8H
Reflection factors	70/50/20
UGR C0/C180	31.6
UGR C90/C270	31.5
CIE Flux Codes	65 88 97 100 100
Ra/CRI	>80

LTS

FLIQ 100.1030.01/DALI

Zubehör



FLIQ 100.01
Dekorrahmen schwarz



FLIQ 100.02
Dekorrahmen silber



FLIQ 100.03
Dekorrahmen weiß



FLIQ 100.04
Lichtefferahmen opal



FLIQ 100.05
Lichtefferahmen klar



FLIQ 100.06
Lichtefferahmen rot matt



FLIQ 100.07
Lichtefferahmen gelb matt



FLIQ 100.08
Lichtefferahmen blau matt



FLIQ 100.16
Lichtefferahmen rot transluzent



FLIQ 100.17
Lichtefferahmen gelb transluzent



FLIQ 100.18
Lichtefferahmen blau transluzent



FLIQ 100.24
Dekoglas opal



FLIQ 100.25
Dekoglas klar