

GRK R 31/4 E



Kurzinformation

Radialgebläse aus Kunststoff mit rundem Ausblas, Baugröße 310, Wechselstrom, 4-Polig

Einsatzbeispiele

Industrieanwendung

Artikelnummer 0073.0510

Technische Daten

Fördervolumen	2.250 m³/h
Drehzahl	1.440 1/min
Lauftradtyp	radial
Drehzahlsteuerbar	–
Reversierbarkeit	–
Spannungsart	Wechselstrom
Bemessungsspannung	230 V
Netzfrequenz	50 Hz
Nennleistung	240 W
I _{Nenn}	1,9 A
Schutzart	IP 55
Wärmeklasse	F
Polumschaltbar	–
Einbauort	Rohranschluss
Einbaulage	horizontal
Material Gehäuse	Kunststoff, Polyethylen
Material Lauftrad	Kunststoff, Polyethylen
Farbe	hellgrau
Gewicht	45 kg
Gewicht mit Verpackung	68 kg
Breite	527 mm
Höhe	640 mm
Tiefe	560 mm
Breite mit Verpackung	1.200 mm
Höhe mit Verpackung	800 mm
Tiefe mit Verpackung	790 mm
Fördermitteltemperatur bei I _{Max}	-15 °C bis 70 °C
PTC DIN 44082	M 100
Verpackungseinheit	1 Stück

GRK R 31/4 E

Sortiment	C
GTIN (EAN)	4012799735106

Schallleistungspegel im Oktavspektrum

	63 Hz	125 Hz	250 Hz	500 Hz	1 kHz	2 kHz	4 kHz	8 kHz	Gesamt
L_{WA5, S5} (dB(A))	49,5	61,6	70,1	70,5	72,7	68,9	60,7	50,6	77

L_{WA5} = Freiansaug-Schallleistungspegel in dB

Kennlinie

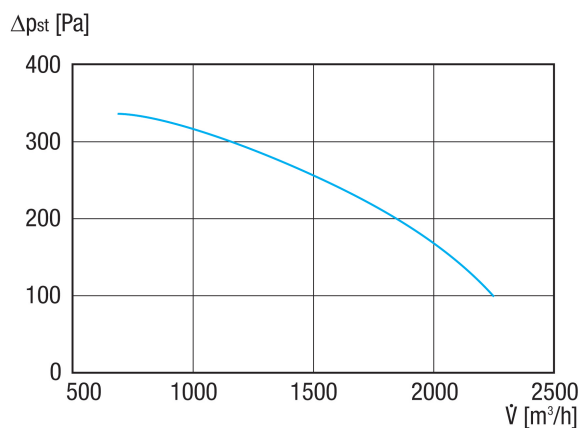

GRK R 31/4 E

Maßzeichnung [mm]

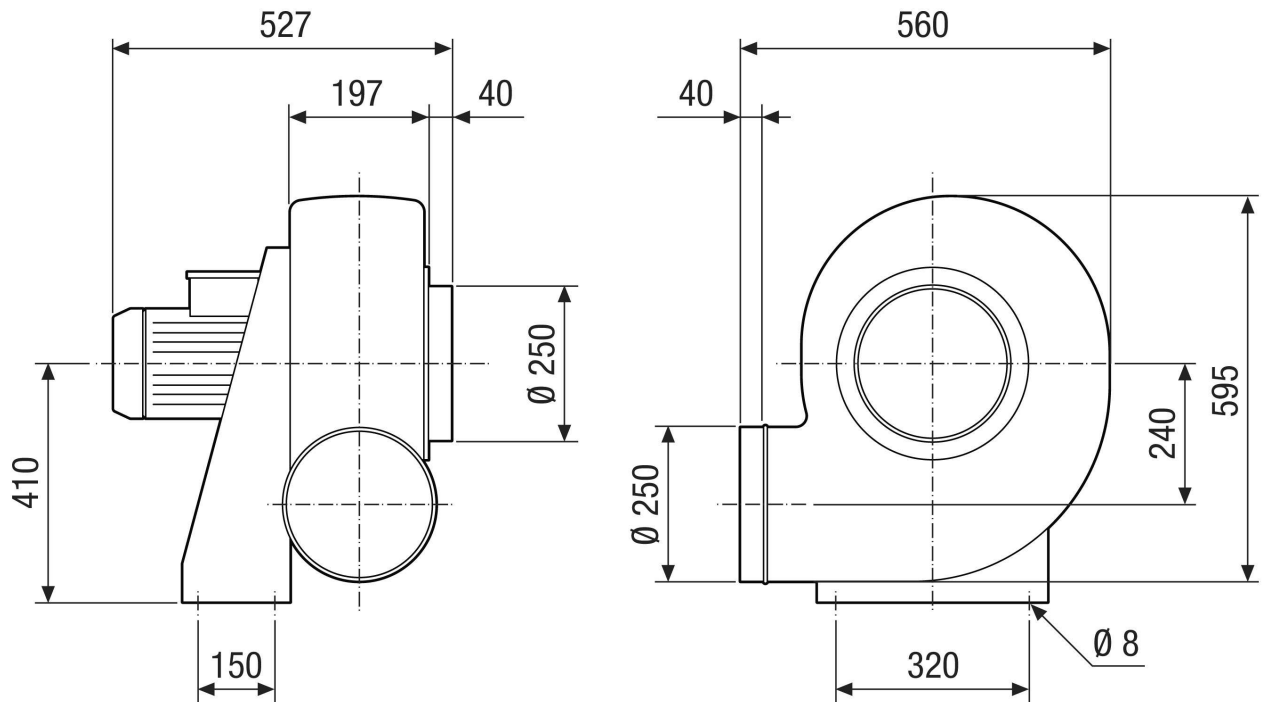

GRK R 31/4 E

Maßzeichnung Gehäuseausrichtung [mm]

①						
	0°	45°	90°	135°	270°	315°
②						

- ① Rechtsausführung
- ② Linksausführung