

Accessories plugs/connectors - Closure cap for CEE plugs



Product description	
BALS-Prd.-Nr	832
EAN	4024941008327
Product category	Closure cap
Current	32A
Number of poles	5p
Poles	3p+N+PE
Protection degree	IP67
Colour code	gray RAL 7035

Product description	
Height	98mm
Width	89mm
Depth	51.5mm
Material of enclosure	Polyamide

Additional technical properties	
	With strap

Logistics data	
Weight/pcs	0.068 kg / Piece
Packaging	Bag
Content amount	1 ST
EAN	4024941008327
Length	51.5 mm
Width	89 mm
Height	98 mm
Weight	0.069 kg
Volume	449.183 ccm
Packaging	Carton
Content amount	10 ST
EAN	4024941946742
Length	275 mm

Logistics data	
Width	175 mm
Height	137 mm
Weight	0.805 kg
Volume	5,737.5 ccm

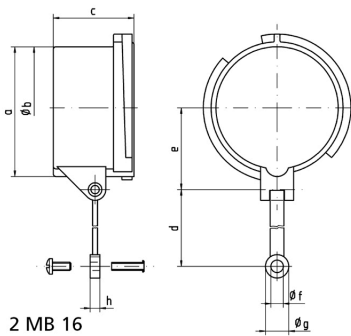

Ampere Polzahl	16 3	16 4	16 5	32 3/4	32 5	63 3/4/5	125 3/4/5
a	53,0	59,5	67,0	70,0	76,5	83,5	95,5
b ø	49,5	55,7	63,0	64,0	70,5	76,5	89,0
c	41,5	41,5	41,5	51,5	51,5	72,5	80,0
d	133,0	133,0	133,0	133,0	133,0	155,0	155,0
e	34,5	38,0	42,0	44,0	48,0	52,0	57,5
f ø	6,4	6,4	6,4	6,4	6,4	6,4	6,4
g ø	12,0	12,0	12,0	12,0	12,0	12,0	12,0
h	5,0	5,0	5,0	5,0	5,0	5,0	5,0