

Montageanleitung / Mounting instruction

- RKS RN2UZD3 -

RKS RN2UZD3 R4

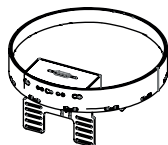

(1)

4x M5x40



RK...R4 *192

250-3

(4a)

(4b)

RKS RN2UZD3 R7

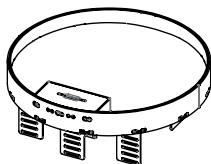

(2)

4x M5x16

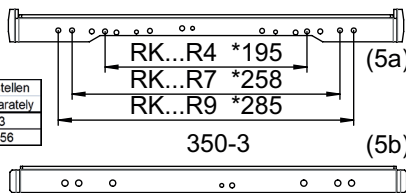

RK...R4 *195

RK...R7 *258

RK...R9 *285

(5a)

(5b)

(3)

4x M4x40



Nivellierwinkel separat bestellen
Order levelling profiles separately

250-3	350-3
7410552	7410556

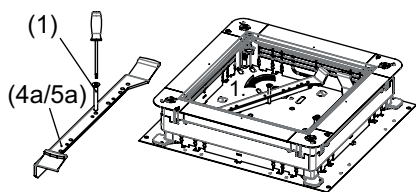

(1)

(4a/5a)

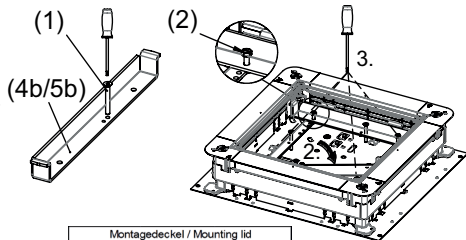

(1)

(4b/5b)

(2)

	250-3		350-3	
	A	B	A	B
RK.../4	224	214	227	216
RK.../7			290	280
RK.../9			317	306

	Montagedeckel / Mounting lid	
	250-3	350-3
RK.../4	7400471	7400517
RK.../7		7400533
RK.../9		7400549

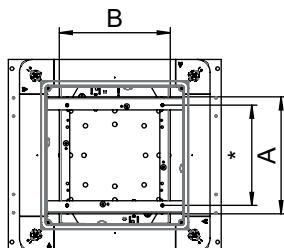

B

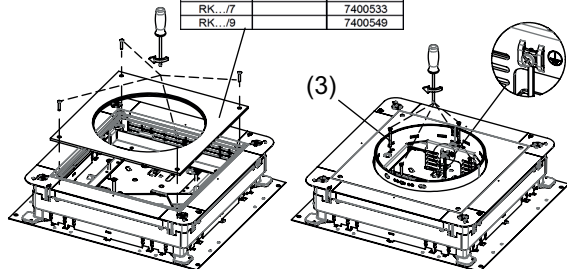

(3)

Montageanleitung / Mounting instruction

- RKSRN2UZD3 -

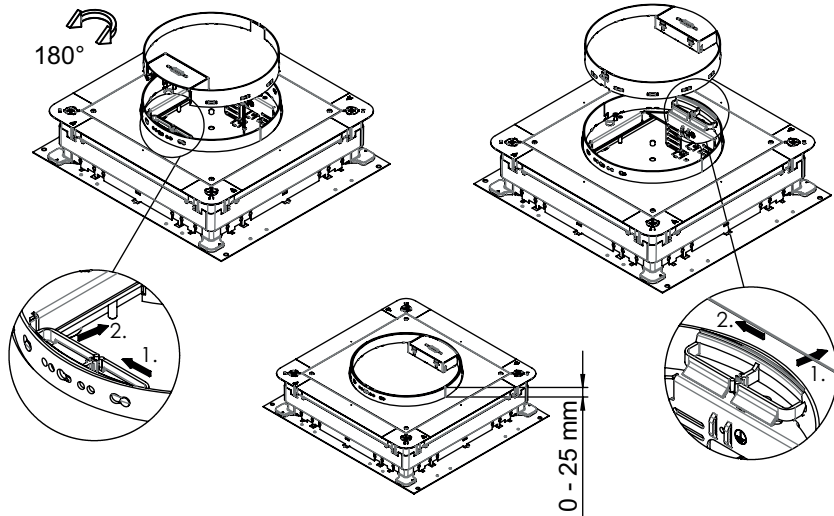

Innenabmessungen der Kassetten
zum Belegen mit Bodenbelag,
lichte Maße in mm.
Fugenbreite entsprechend
Bodenbelagsart.

Inside dimensions of the cassettes
for floor covering,
all measurements in mm.
Seam width acc. to floor covering.

Nenngröße Nominal Size	A	C	D
R4	Ø 199	155	96
R7	Ø 259	215	96
R9	Ø 289	245	96

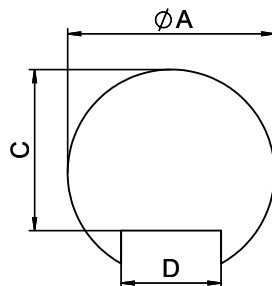

**OBO Bettermann
Holding GmbH & Co. KG**
P. O. Box 1120
58694 Menden
GERMANY

Customer Service:
Tel.: +49 2373 89 - 17 00
Fax.: +49 2373 89 -12 38
info@obo.de
www.obo-bettermann.com