



# LANOS M/L

surface-mounted (ceiling/wall)

Zumtobel Lighting GmbH  
Schweizerstrasse 30  
6850 Dornbirn AUSTRIA



ZUMTOBEL

LANOS D/DI M (400 mm)  
LANOS D/DI L (500 mm)

LRO (UGR <19)

EVG, LDE, HL LDE  
BC, BCM, LDE BCM, HL BC  
COR, COZ, CORM, COZM  
HL COZ, HL COZM  
MWS, LDE MWS, HL MWS

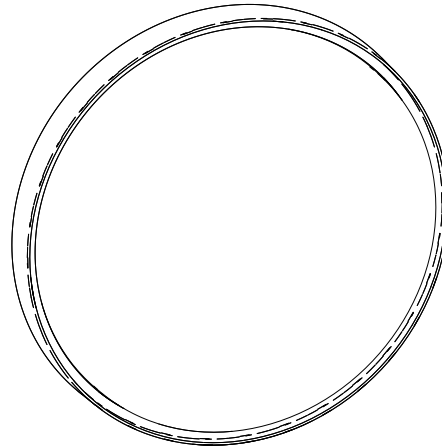

96413171z01

E3, E3D emergency lighting self-contained (battery)  
emergency lighting (centrally supplied with LDE only)



ceiling+wall ONLY:  
IP54 IK08



## EN Mounting instructions

Important notices. Please, read first! Keep the instructions safe! Specifications are subject to change without notice! If you have questions, please contact the manufacturer.

## DE Montageanleitung

Wichtige Hinweise. Bitte zuerst lesen! Anleitung aufbewahren! Technische Änderungen vorbehalten! Bei Fragen wenden Sie sich an den Hersteller.

## FR Notice de montage

Remarques importantes. À lire en premier lieu! Conservez cette notice! Modifications techniques sans préavis! Si vous avez des questions, veuillez contacter le fabricant.

## IT Istruzioni di montaggio

Nota importanti. Si prega di leggere prima! Conservare le istruzioni! Modifiche tecniche senza preavviso! Per chiarimenti rivolgersi al produttore.

## ES Instrucciones de montaje

Notas importantes. Por favor, lea primero! ¡Guarde las instrucciones! ¡Reservado el derecho de realizar modificaciones técnicas sin preaviso! Si tiene alguna pregunta, póngase en contacto con el fabricante.

## NL Montagehandleiding

Belangrijke informatie. Gelieve eerst te lezen! Houd deze gebruiksaanwijzingen zorgvuldig bij! Technische wijzigingen blijven voorbehouden! Als u vragen hebt, kan u contact opnemen met de fabrikant.

## SV Installationsanvisning

Viktigt information. Läs först! Spara anvisningen! Med reservation för tekniska ändringar! Om du har frågor ber vi dig ta kontakt med tillverkaren.

## FI Asennusohje

Tärkeä huomautus. Lue ensin! Säilytä käyttöopas! Oikeudet teknisiin muutoksiin pidätetään! Lähetä mahdolliset kysymykset valmistajalle.

## RU Инструкция по монтажу

Важная информация. Просьба ознакомиться перед началом работ! Сохраняйте инструкцию! Компания сохраняет за собой право на внесение технических изменений. При возникновении вопросов обращайтесь к производителю.

## PL Instrukcja montażu

Ważne wskazówki/ uwagi. Proszę pierwsze przeczytać całość instrukcji. Proszę zachować instrukcję! Zastrzega się prawo do wprowadzania zmian technicznych. W razie pytań skontaktuj się z producentem.

## ZH 安装说明

重要提示。请先阅读！保留本说明！请勿执行技术变动！如有问题，请咨询制造商。

## AR

تعليمات التركيب

ملاحظات هامة. يرجى القراءة أولاً!

إبقاء التعليمات!

تخضع المواصفات للتغيير دون تقديم إشعار!

إذا كان لديك أسئلة، الرجاء الاتصال بالشركة المصنعة.

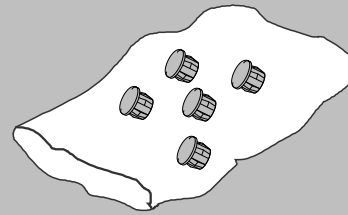
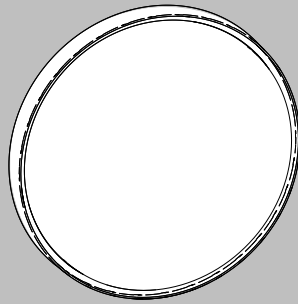

incl. accessories (inside)

## i dimensions

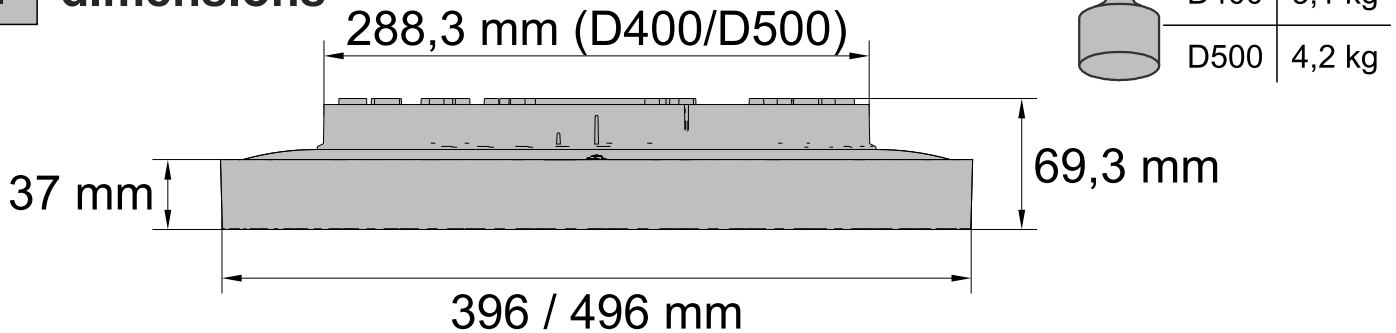

## i ceiling+wall ONLY: IP54 IK08 MOUNTING OPTIONS (overview)

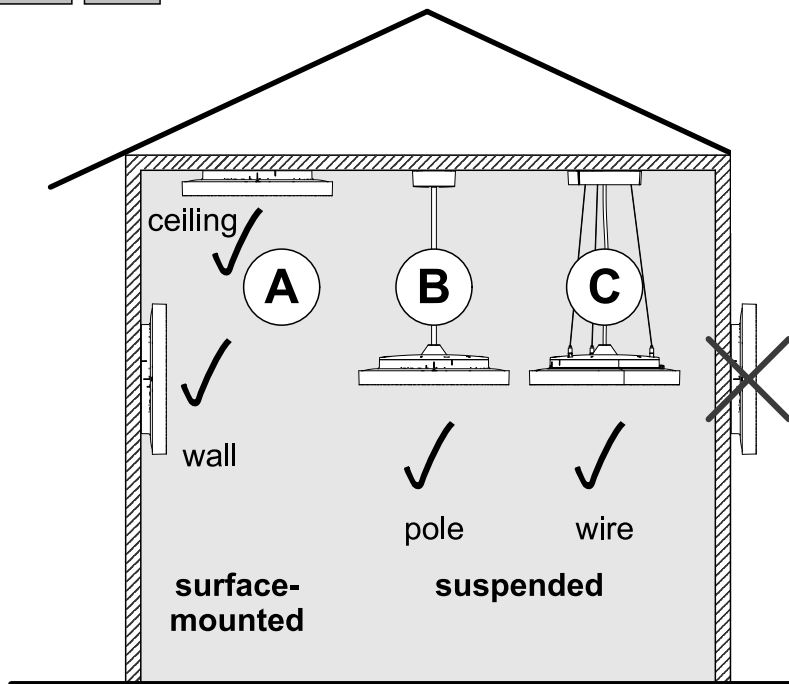

**A:**

LANOS surface-mounted (ceiling/wall)  
LANOS D/DI M (400 mm)  
LANOS D/DI L (500 mm)  
LRO (UGR <19)  
EVG, LDE, HL LDE  
BC, BCM, HL BC  
COR, COZ, CORM, COZM  
HL COZ, HL COZM  
MWS, LDE MWS, HL MWS

**96413171**

**B:**

LANOS suspended (pole)  
LANOS D/DI M (400 mm)  
LANOS D/DI L (500 mm)  
LRO (UGR <19)  
EVG, LDE, HL LDE  
BC, BCM, HL BC  
COR, COZ, CORM, COZM  
HL COZ, HL COZM  
MWS, LDE MWS, HL MWS

**96415811**

**C:**

LANOS suspended (wire)  
LANOS D/DI M (400 mm)  
LANOS D/DI L (500 mm)  
LRO (UGR <19)  
EVG, LDE, HL LDE  
BC, BCM, HL BC  
COR, COZ, CORM, COZM  
HL COZ, HL COZM  
MWS, LDE MWS, HL MWS

**96415812**

## i MOUNTING OPTIONS B+C ONLY: accessory kits



- 22172102 pole suspension 1 m (LANOS M/L SUSP SET AP1 WH)
- 22172103 pole suspension 1,8 m (LANOS M/L SUSP SET AP2 WH)
- 22171790 wire suspension 2 m (LANOS M/L SUSP SET AST2 WH)
- 22171791 wire suspension 4 m (LANOS M/L SUSP SET AST4 WH)

# 1 MOUNTING OPTION A: ceiling/wall

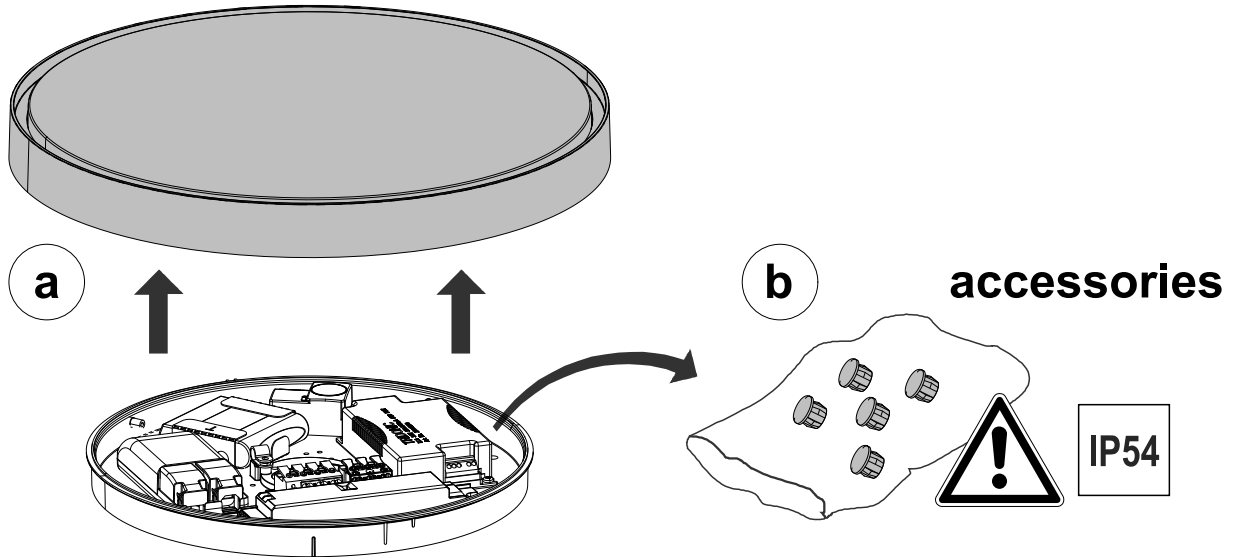

# 2 MOUNTING OPTION A: ceiling/wall

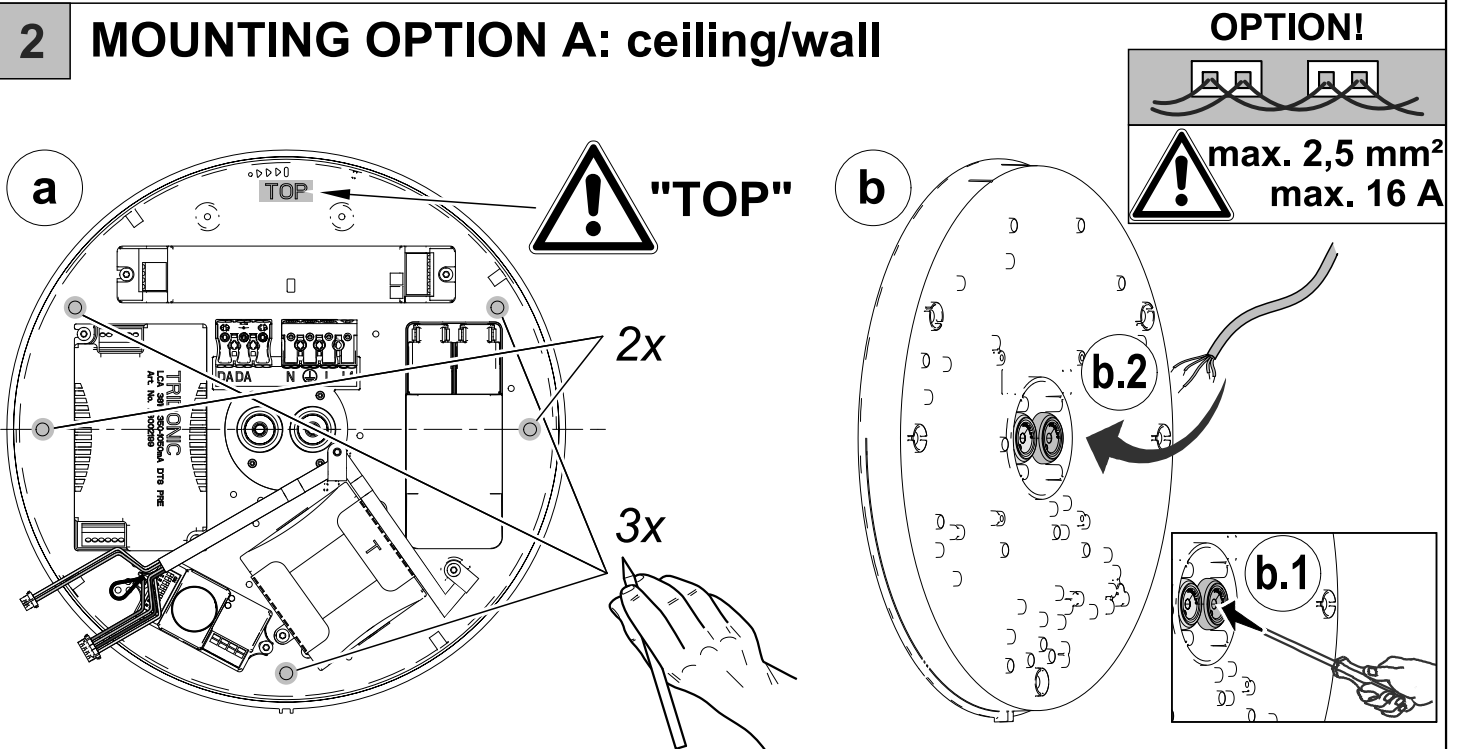

## ! CLOSE OPENINGS from the back

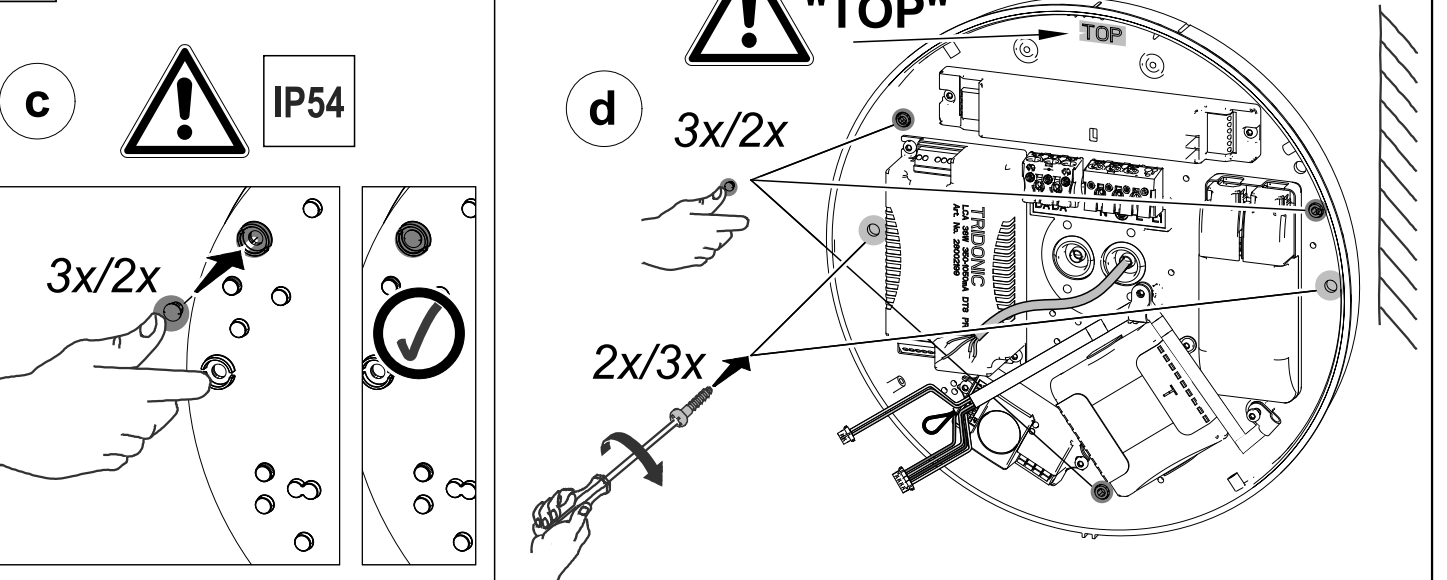

3



### MOUNTING OPTION A: ceiling/wall

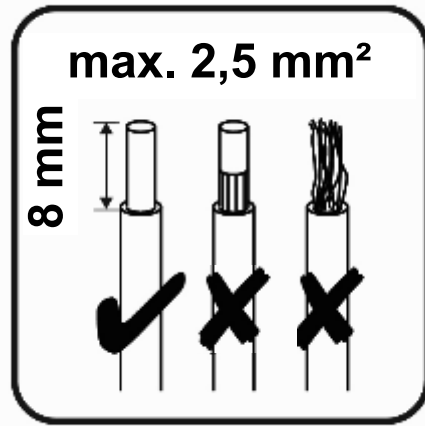
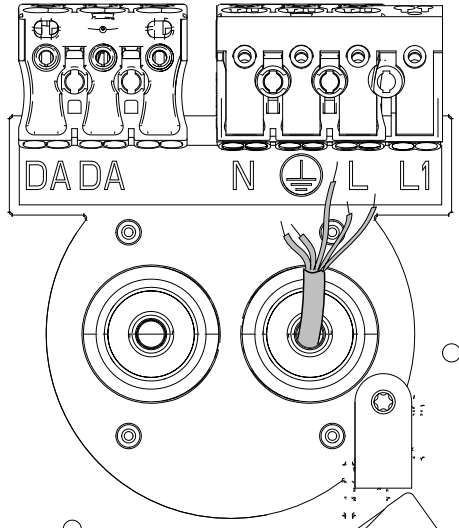

i



### WIRING DIAGRAMS: Standalone luminaires

EVG / BC / HL BC

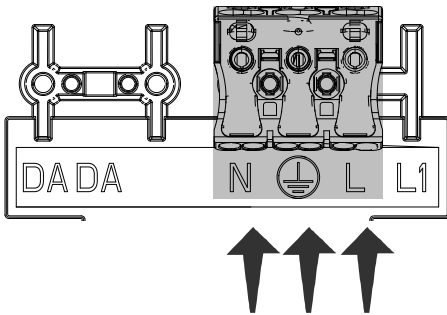

LDE / HL LDE

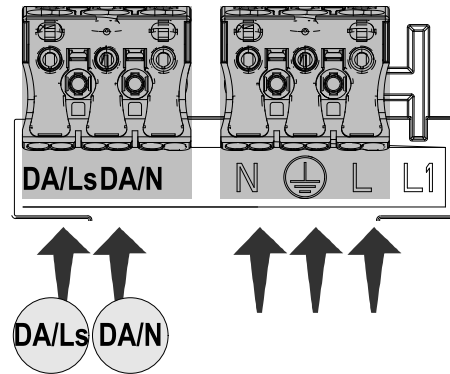

EVG E3 / BC E3 / HL BC E3

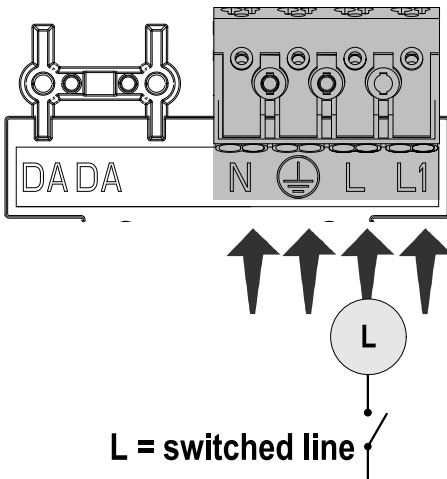

LDE E3

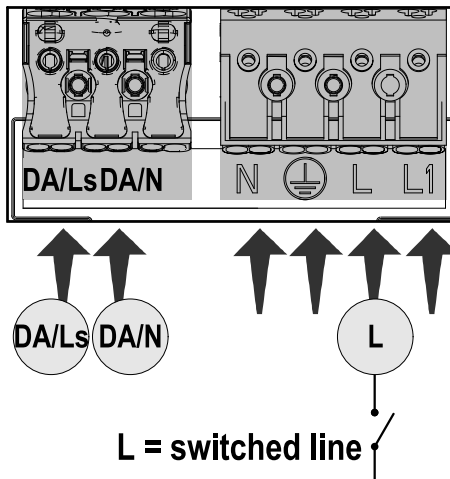

LDE E3D / BC E3D / HL BC E3D

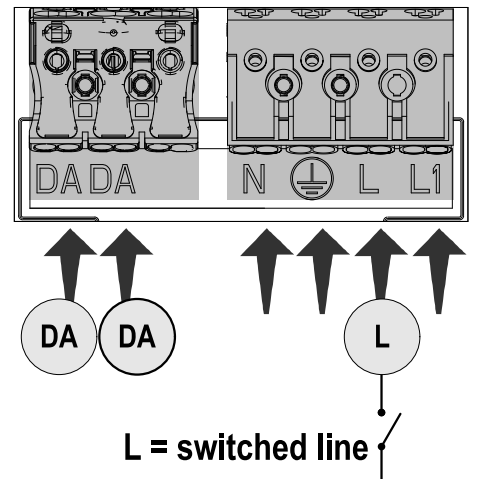

**Initiator**

**Follower**

**Follower**

MWS / BCM

EVG

EVG E3

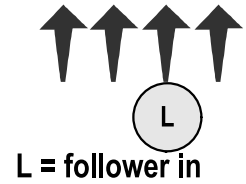
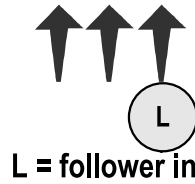
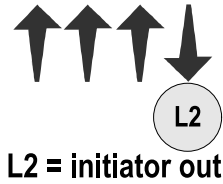
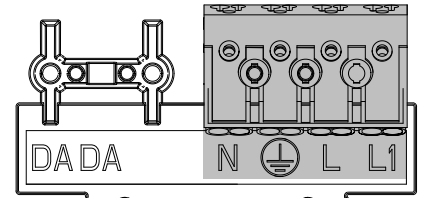
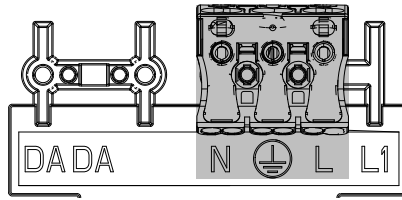
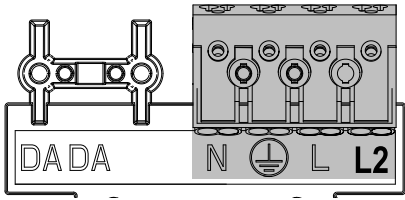

x10 MAX

MWS E3 / BCM E3

EVG

EVG E3

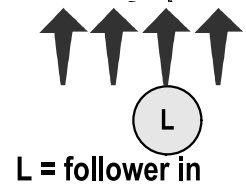
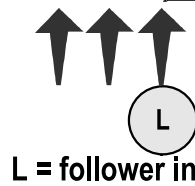
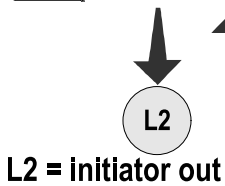
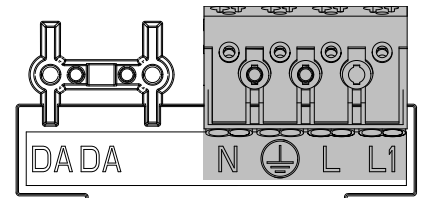
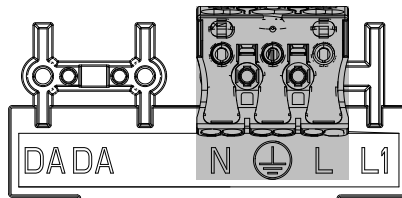
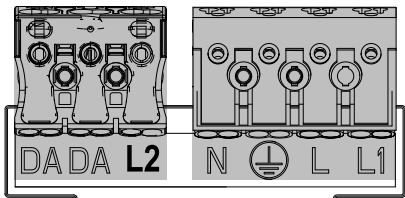

x10 MAX

CORM / COZM / HL COZM

COR/COZ / HL COZ

COR/COZ E3 / HL COZ E3

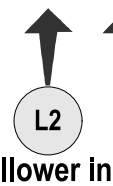
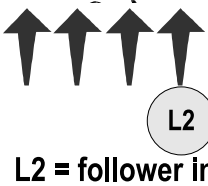
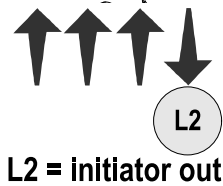
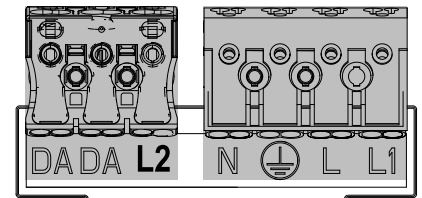
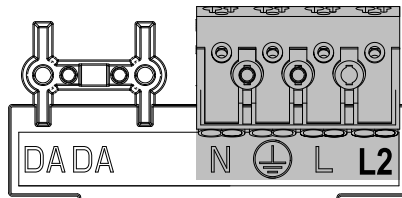
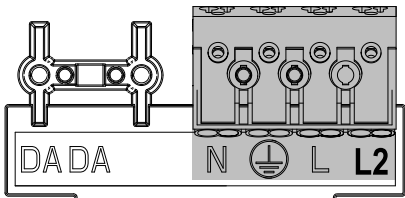

x10 MAX

CORM/COZM E3 / HL COZM E3

COR/COZ / HL COZ

COR/COZ E3 / HL COZ E3

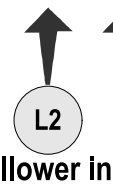
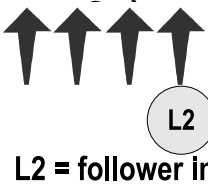
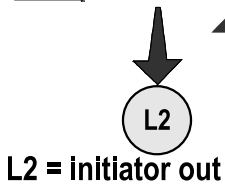
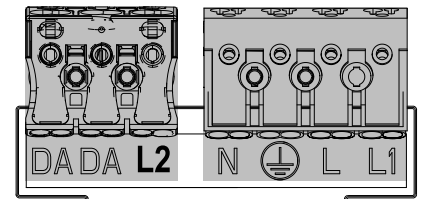
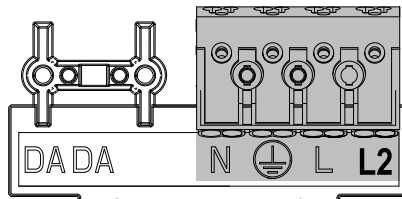
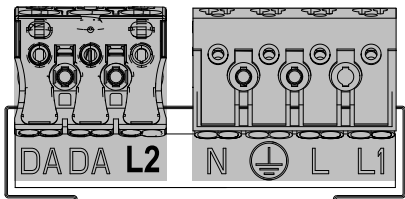

x10 MAX

**Initiator**

**Follower**

**Follower**

MWS E3D / LDE MWS E3D /  
BCM E3D / LDE BCM E3D

EVG

EVG E3D

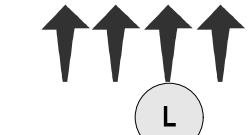
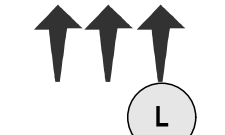
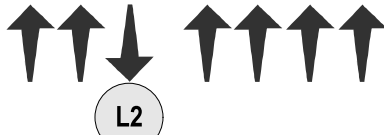
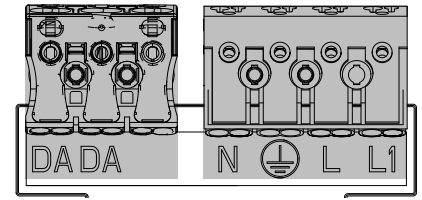
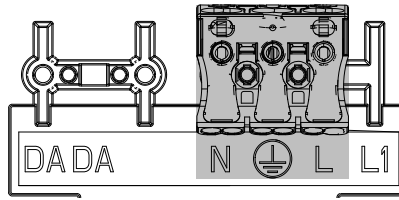
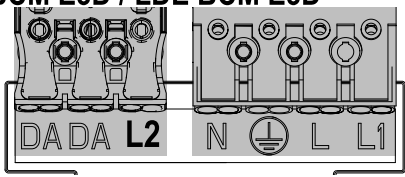

L2 = initiator out

L = follower in

L = follower in

x10 MAX

CORM/COZM E3D /  
HL COZM E3D / HL MWS E3D

HL LDE E3D

COR/COZ E3D / HL COZ E3D

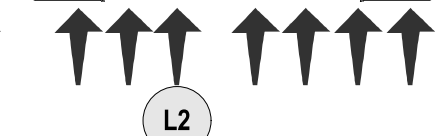
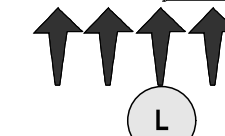
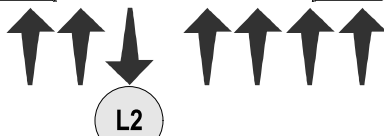
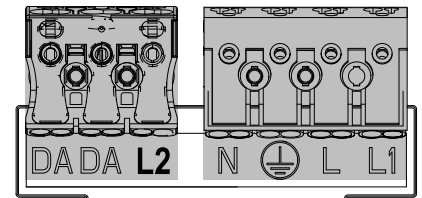
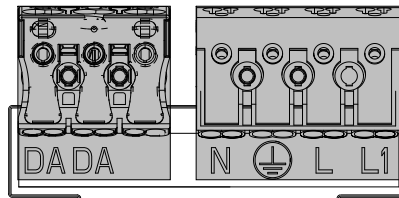
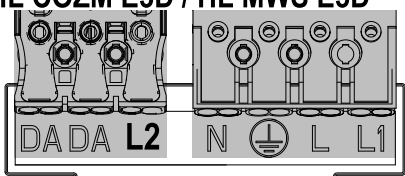

L2 = initiator out

L = follower in

L2 = follower in

x10 MAX

HL MWS / LDE MWS / LDE BCM

LDE / HL LDE

HL LDE E3

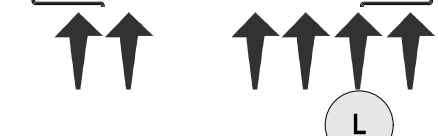
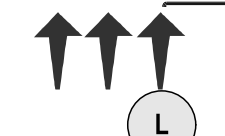
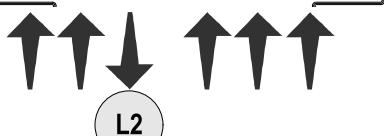
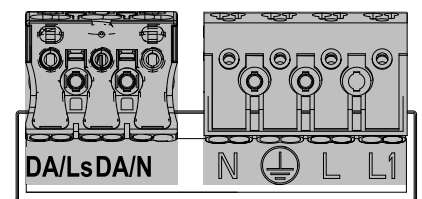
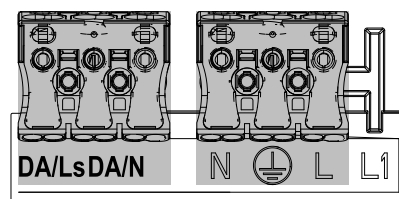
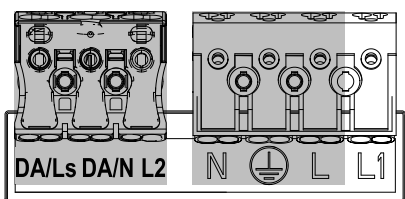

L2 = initiator out

L = follower in

L = follower in

x10 MAX

HL MWS E3 / LDE MWS E3 /  
LDE BCM E3

LDE / HL LDE

HL LDE E3

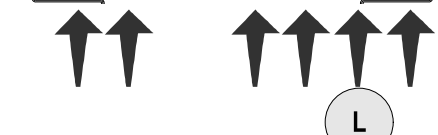
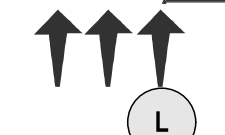
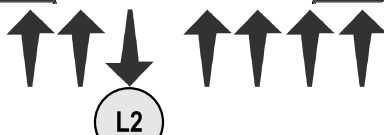
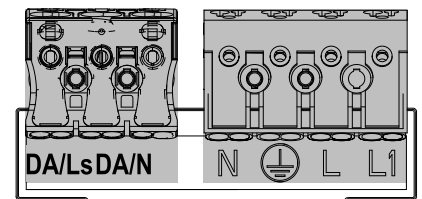
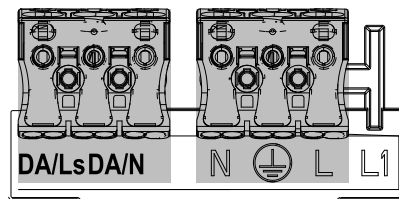
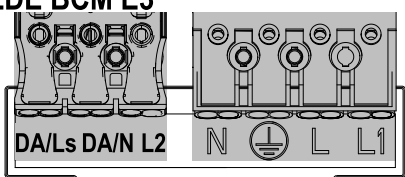

L2 = initiator out

L = follower in

L = follower in

x10 MAX

**(4) OPTION E3, E3D: emergency self-contained (battery)**

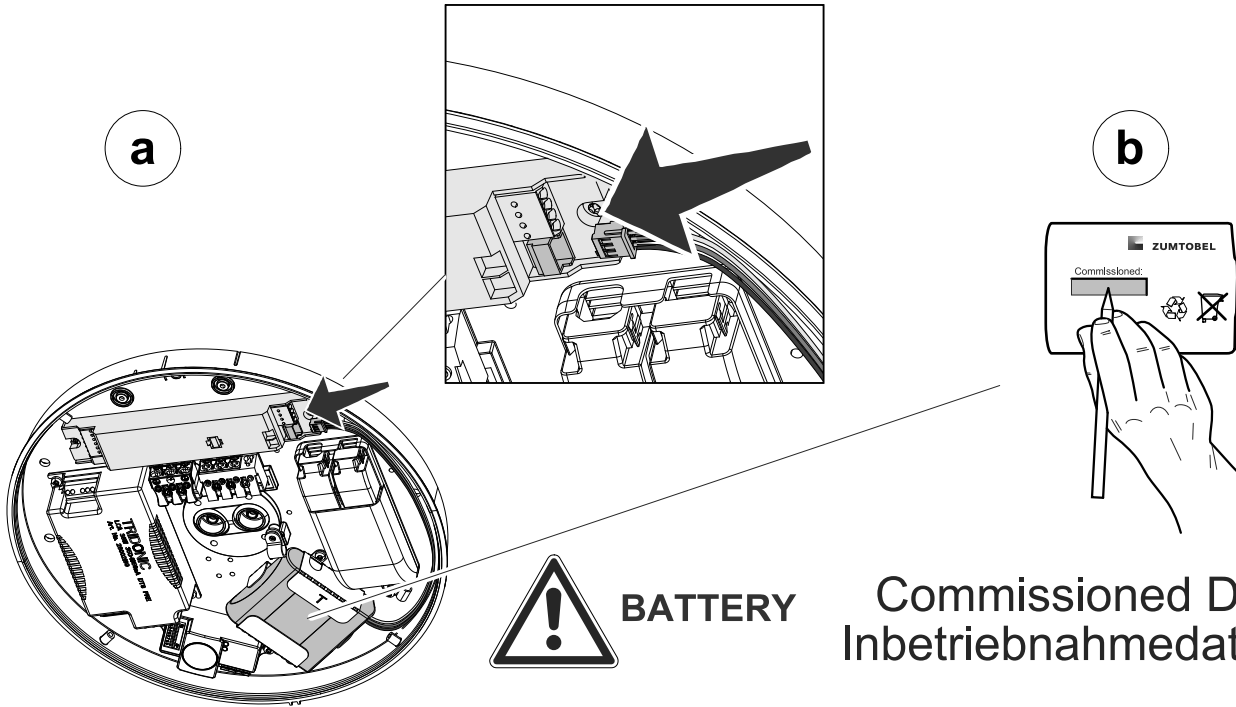

**i**  **Change battery**

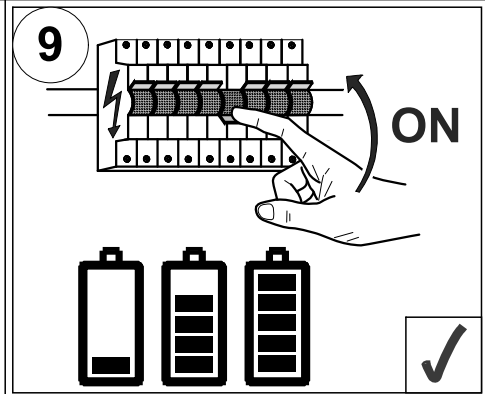
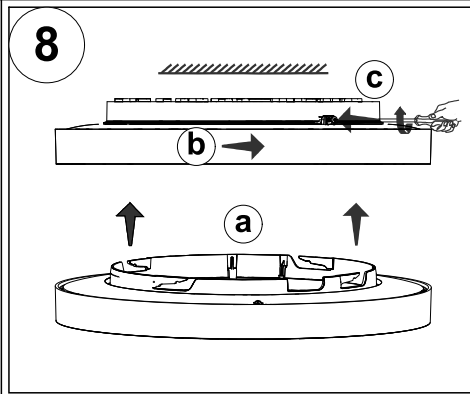
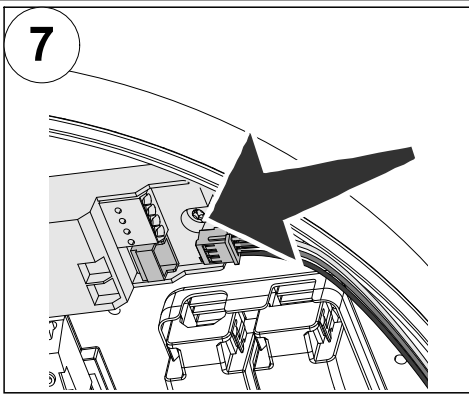
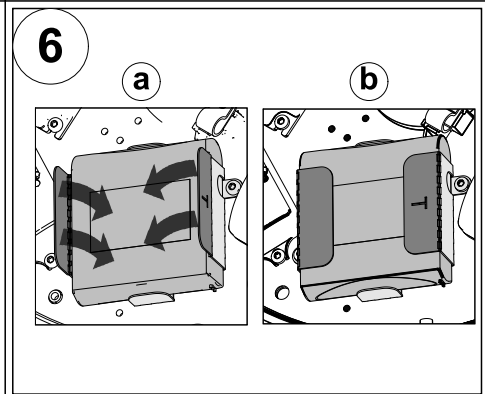
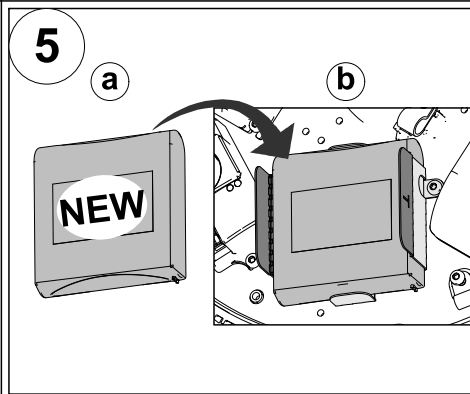
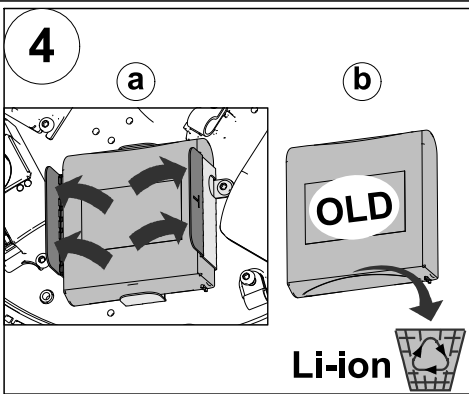
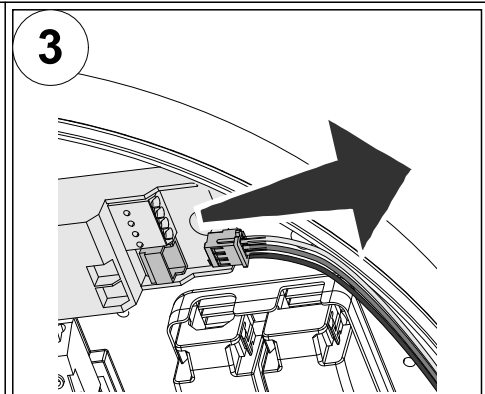
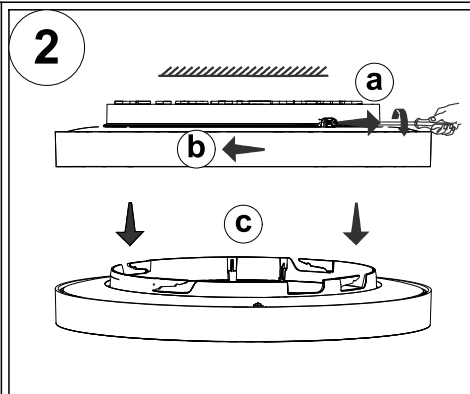
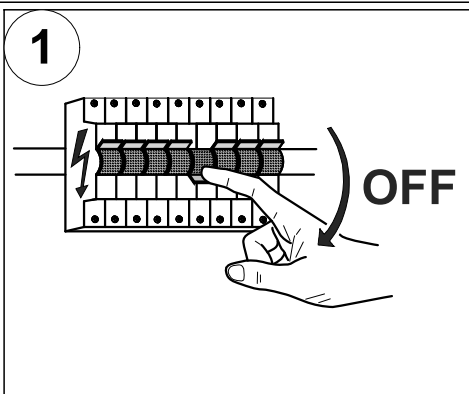

# 5 MOUNTING OPTION A: ceiling/wall

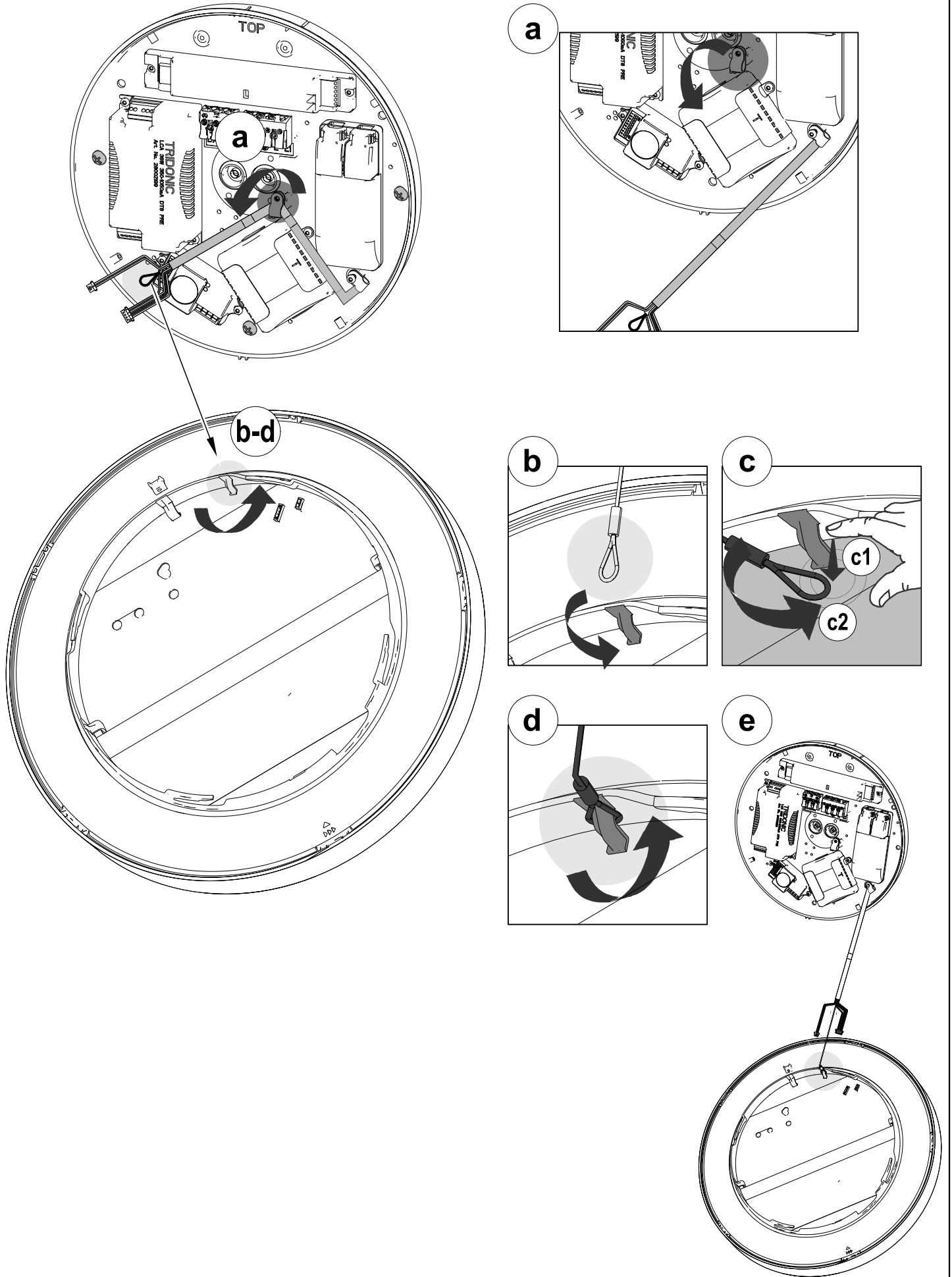



## 6 MOUNTING OPTION A: ceiling/wall

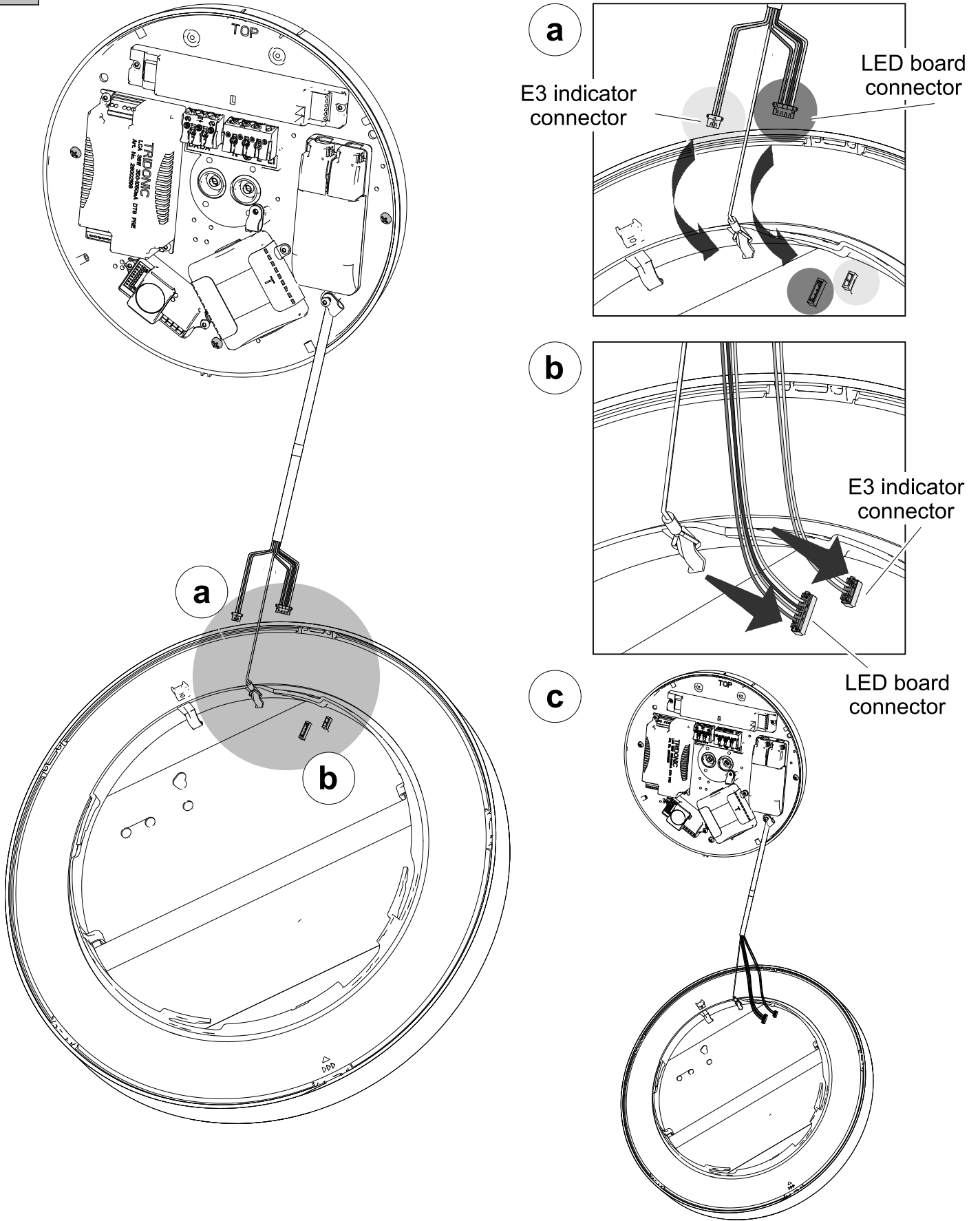

## (7) OPTION SENSOR MWS

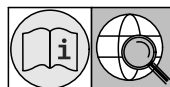
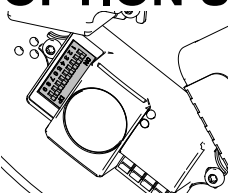

[www.zumtobel.com/PDB/Ressource/manual/96416800.pdf](http://www.zumtobel.com/PDB/Ressource/manual/96416800.pdf)

## 8 MOUNTING OPTION A: ceiling/wall

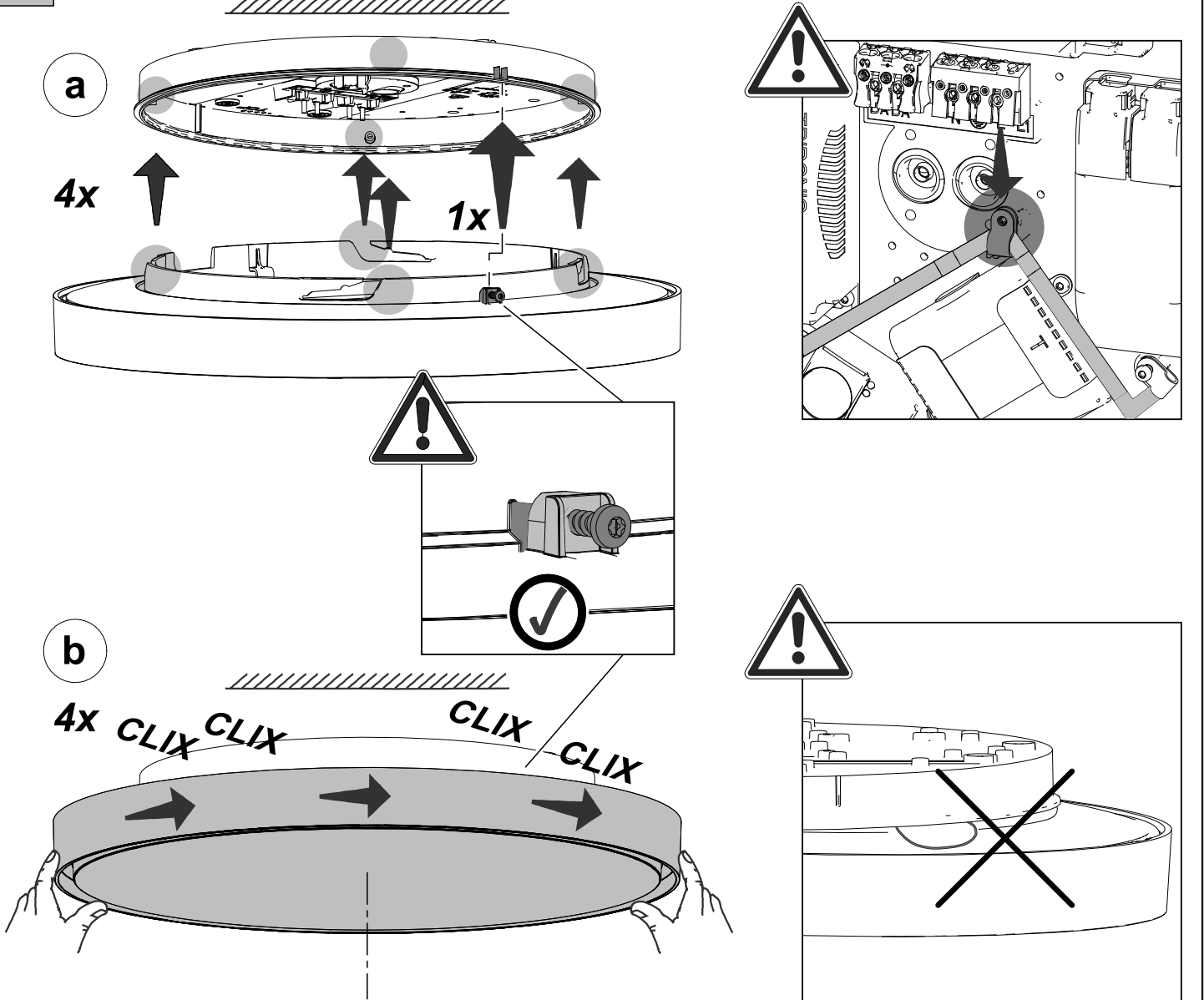

## 9 MOUNTING OPTION A: ceiling/wall

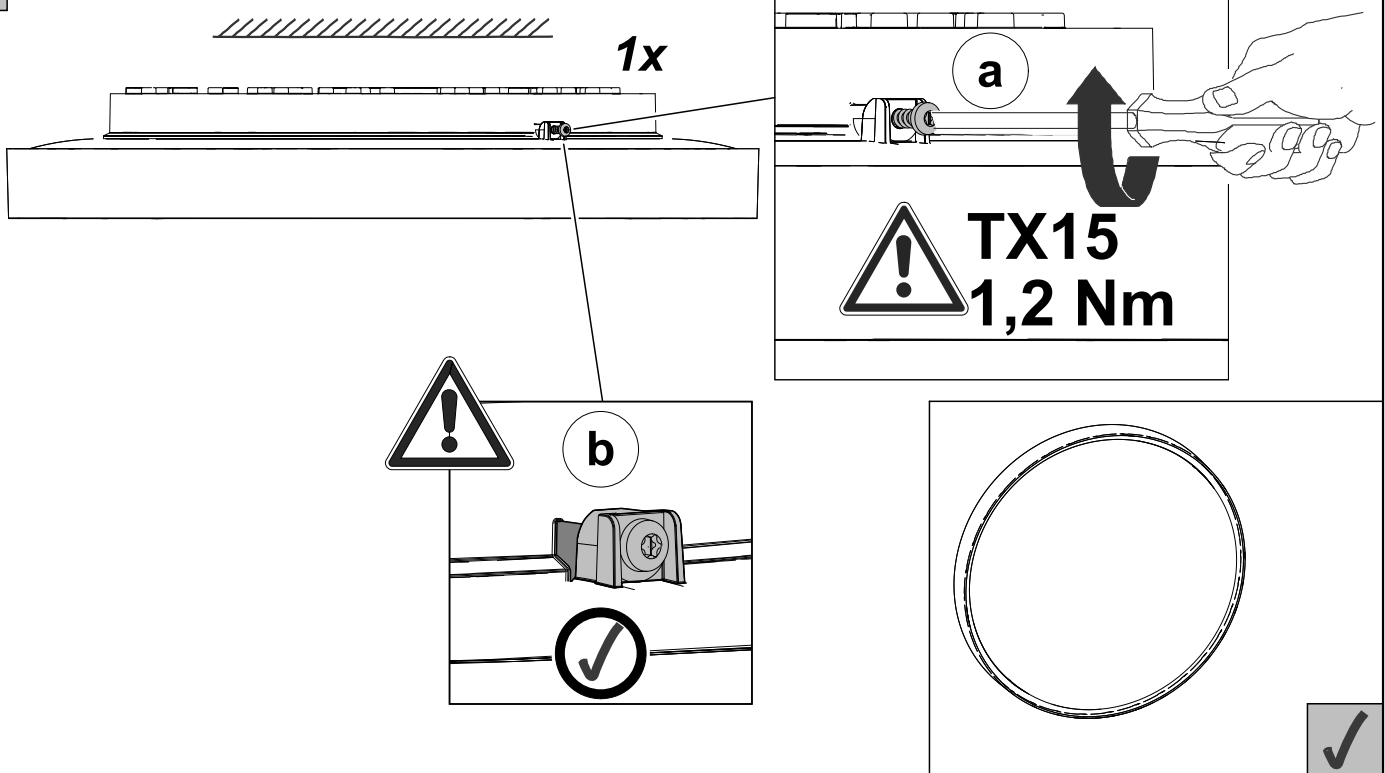

## **DE** Hinweise für die Montage und den Betrieb!

Die Montage und Inbetriebnahme der Leuchte sowie jede Veränderung an der Leuchte darf nur von autorisierten Fachkräften (qualifizierter Elektriker) durchgeführt werden. Die nationalen Errichterbestimmungen sind zu beachten. Vor jeder Arbeit an der Leuchte ist diese vom Netz zu trennen. **Hot Plug-in ist nicht möglich und kann zu Schäden an der Leuchte führen!** Der Hersteller haftet nicht für Schäden, die aus fehlerhafter Montage, aus unsachgemäßem Betrieb oder unautorisierten Veränderungen an der Leuchte resultieren. Die Lichtquelle dieser Leuchte darf nur vom Hersteller oder einem von ihm beauftragten Servicetechniker oder einer vergleichbar qualifizierten Person ausgetauscht werden. **Vorsicht, Gefahr eines elektrischen Schlags!** Technische Änderungen vorbehalten! Bei Fragen wenden sie sich an den Hersteller.



## **EN** Instructions for installation and operation!

The installation and commissioning of the luminaire as well as any modification to the luminaire may only be performed by authorized personnel (qualified electrician). National installation regulations must be observed. Before any work on the appliance is done, it must be disconnected from mains. **Hot plug-in is not an option and may cause damage to the lamp or luminaire!** The manufacturer is not liable for damages resulting from improper or faulty installation or operation or from unauthorized modifications to the luminaire. The light source contained in this luminaire shall only be replaced by the manufacturer or his service agent or a similarly qualified person.



**Caution, risk of electric shock!**

Specifications are subject to change without notice! If you have questions, please contact the manufacturer.

## **FR** Instructions pour l'installation et l'utilisation!

L'installation et la mise en service du luminaire ainsi que toute modification au luminaire doivent être effectuées par un personnel autorisé (électricien qualifié). Les règles nationales d'installation doivent être respectées. Avant toute intervention sur l'appareil, il doit être débranché de son alimentation. **Le branchement à chaud est interdit, et peut endommager à la lampe ou le luminaire!** Le fabricant décline toute responsabilité pour les dommages résultant d'une mauvaise installation ou opération, ou d'une modification non autorisée du luminaire. La source lumineuse présente dans le luminaire ne peut être remplacée que par le fabricant, par son service technique ou une personne qualifiée. **Avertissement, risque de choc électrique.** Sous réserve de modifications des spécifications techniques! Pour toute question, contactez le fabricant.



## **IT** Istruzioni per l'installazione e il funzionamento!

L'installazione e la messa in servizio degli apparecchi, nonché qualsiasi modifica dell'apparecchio può essere eseguita solo da personale autorizzato (elettricista qualificato). Le norme nazionali di installazione devono essere rispettate. Prima di qualsiasi intervento sull'apparecchio, questo deve essere scollegato dalla rete. **Non è possibile un Hot Plug In e può causare danni alla lampada o all'apparecchio!** Il produttore non si assume alcuna responsabilità per i danni derivanti da un'installazione impropria o difettosa, o per modifiche non autorizzate apportate all'apparecchio. La sorgente luminosa contenuta in questo apparecchio può essere sostituita solo dal produttore o da un centro assistenza autorizzato o da una persona qualificata. **Attenzione, rischio di folgorazione!** Modifiche tecniche sono soggette a cambiamenti senza preavviso! Se avete domande, si prega di contattare il produttore.



## **NL** Aanwijzingen voor installatie en bediening!

De installatie en inbedrijfstelling van het armatuur, alsook elke wijziging in of aan het armatuur mogen alleen door bevoegd personeel (elektricien) worden uitgevoerd. De nationale installatie voorschriften moeten worden nageleefd. Voor alle werkzaamheden aan het apparaat, moet deze worden losgekoppeld van het net. **Hot plug-in is niet mogelijk en kan schade aan de lichtbron of het verlichtingstoestel veroorzaken!** De fabrikant is niet aansprakelijk voor schade als gevolg van onjuiste of foutieve installatie, bediening of schade welke het gevolg zijn van niet geautoriseerde wijzigingen aan het armatuur. De lichtbron in dit armatuur mag enkel door de fabrikant, een service agent of een gelijkwaardig gekwalificeerd persoon vervangen worden. **WAARSCHUWING: Gevaar voor elektrische schokken.** Technische wijzigingen voorbehouden! Als u vragen hebt, kunt u contact opnemen met de fabrikant.



## **i** Info on (non-) replaceability:

