

Transfer or duplication of this document as well as the utilisation or communication of its content are not permitted unless express consent is granted. Violations give rise to claims for damages. All rights reserved in case of patent, utility model or design patent registrations. Tolerance specifications do not include clearances inherent in the design.

Weitergabe sowie Vervielfältigung dieses Dokuments, Verwertung und Mitteilung seines Inhalts sind verboten, soweit nicht ausdrücklich gestattet. Zuwiderhandlungen verpflichten zu Schadensersatz. Alle Rechte für den Fall der Patent-, Gebrauchsmuster- oder Designeintragung vorbehalten. Bauartbedingtes Spiel ist in den Toleranzangaben nicht berücksichtigt.

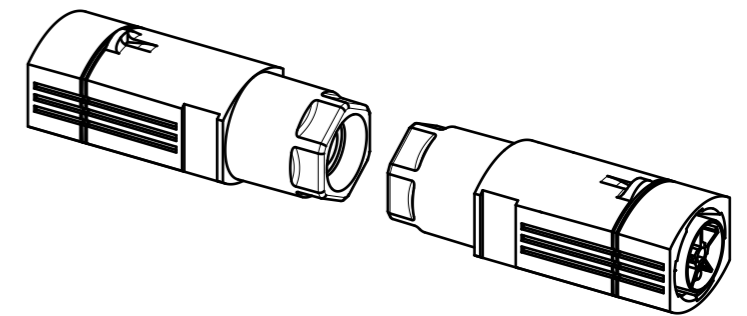
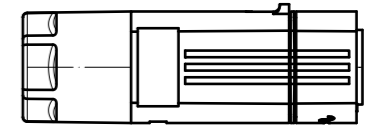
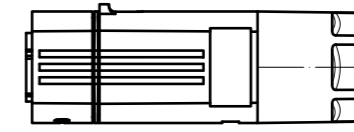
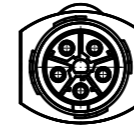
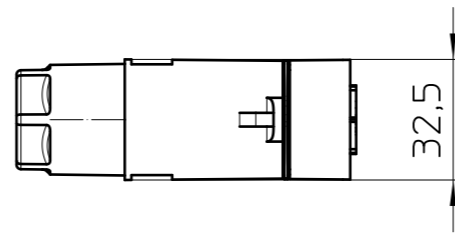
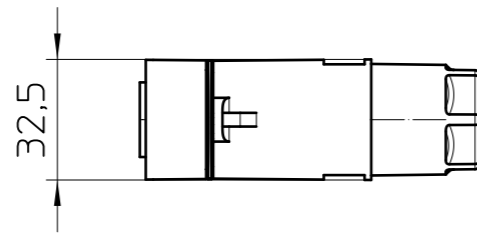
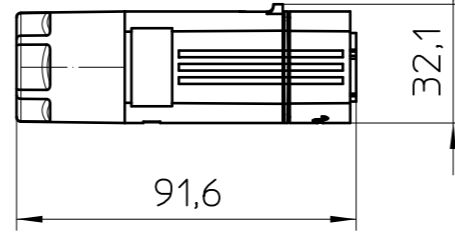
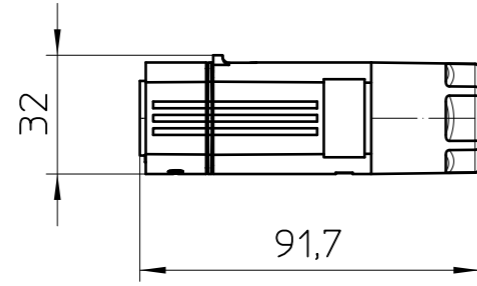

- EN ISO 291 23/50

	document-no. / ri	article-no.	scale	<ul style="list-style-type: none"> - Simplified representation - Document excluded from change process - Linear dimensions [mm]
	01555093 / 00	1526887	1:2	
	date	document-type		
	05.05.2023	TECDOC 2D_Productdrawing		
page 1	of 1	description		
		IPD PL 5P2,5 M A0,5 F PVC GY		