

Kunststoffrändelmutter M5  
Plastic knurl nut M5

Verteilerplatte austauschbar  
für ST, SC, SC-D, ...  
(nicht enthalten / separat zu bestellen)  
Distribution plate, exchangeable  
for ST, SC, SC-D, ...  
(not included / to order separately)

Gehäuse  
Spleißbox IP66-M-V  
Housing  
Splice Box IP66-M-V

Speißkassette mit Deckel  
(nicht enthalten / separat zu bestellen)  
Splice cassette with cover  
(not included/to order separately)

Befestigungsblech für Spleißkassetten  
mit Gewindebolzen M5x70  
Mounting plate for splice cassettes  
with thread bolt M5x70

für Wandbefestigung: 4 Schrauben  $\varnothing 4,5$  im Raster 346 x 239mm  
oder im Raster 240 x 190mm (nicht enthalten)  
for wall mounting: 4 screws  $\varnothing 4,5$ , spacing 346x239mm  
or spacing 240x190mm (not included)

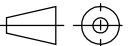
2010	Datum/ date	Name/ name	Gewicht/ weight [g]	Oberfläche/ surface [mm <sup>2</sup> ]	Werkstoff/ material	Gehäuse/Housing - PS (Polystyrol)
gez./ drawn	08.12.	SW	-	-	Oberfläche/ finish	lichtgrau/light grey RAL7035
gepr./ appr.	08.12.10	KR				
Norm/ stand.						
Maßstab/ scale	Benennung/ title LWL-Spleißbox IP66-M-V mit Befestigungsblech 360x254x111 FO-Splice Box IP66-M-V with mounting plate					
untol./ dim. without tolerances according to	Untert./doc. type	Zeichnungsnr./ drawing no.		 <b>Telegärtner</b> GERÄTEBAU GMBH		
DIN 7168	K	H02050A0231		 Maße/ dimensions: mm		
Änd./ rev. index	Änderungsmittlung/ revision code	Datum/ date	Name/ name	Original : DIN A3 infor-089574		
				Blatt/ sheet 1 von/ of 2		

für max. 6 Spleißkassetten Nokia oder  
 für max. 8 Spleißkassetten Telekom  
 ohne Verteilerplatte  
*for max. 6 Splice cassette Nokia or  
 for max. 8 Splice cassette Telekom  
 without Distribution plate*

**oder/or**

für max. 3 Spleißkassetten Nokia  
 mit 1 Verteilerplatte oder  
 für max. 3 Spleißkassetten Telekom  
 mit 1 Verteilerplatte  
*for max. 3 Splice cassetts Nokia  
 with 1 Distribution plate or  
 for max. 3 Splice cassetts Telekom  
 with 1 Distribution plate*

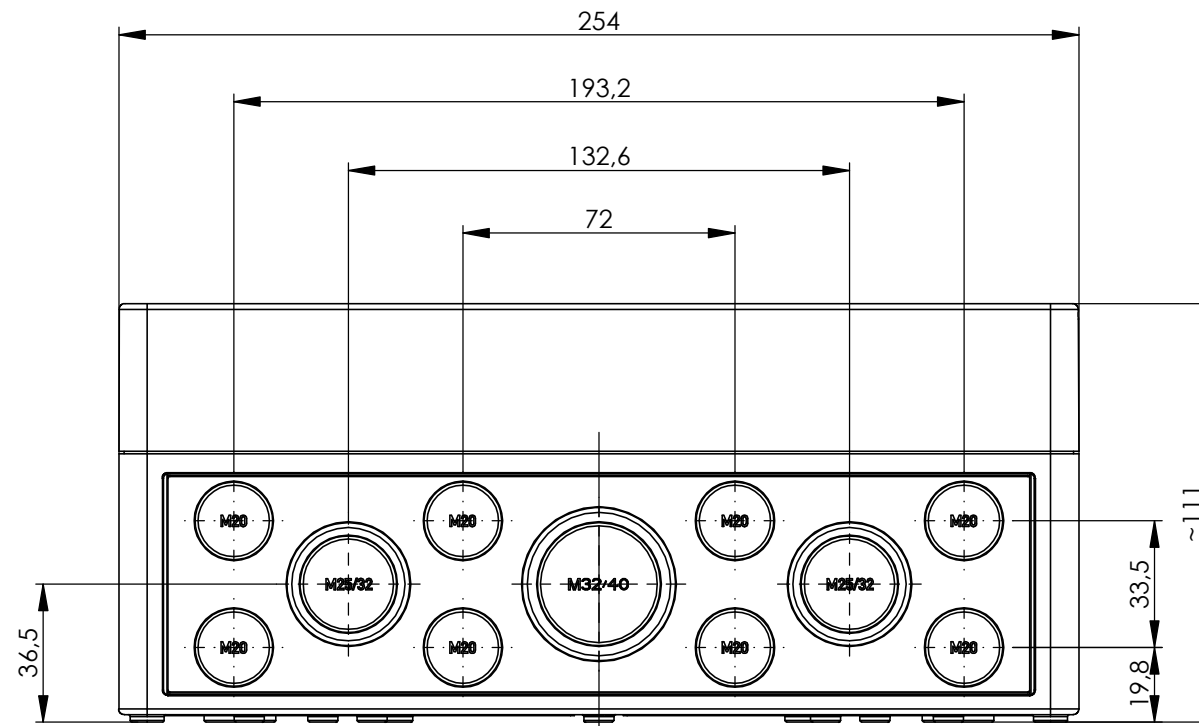
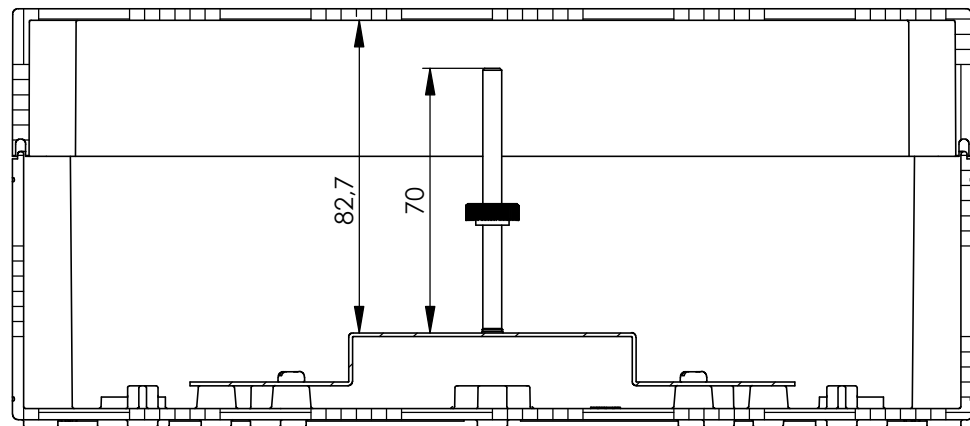

Vorprägungen/  
*knockouts:*  
 8x M20  
 2x M25/32  
 1x M32/40

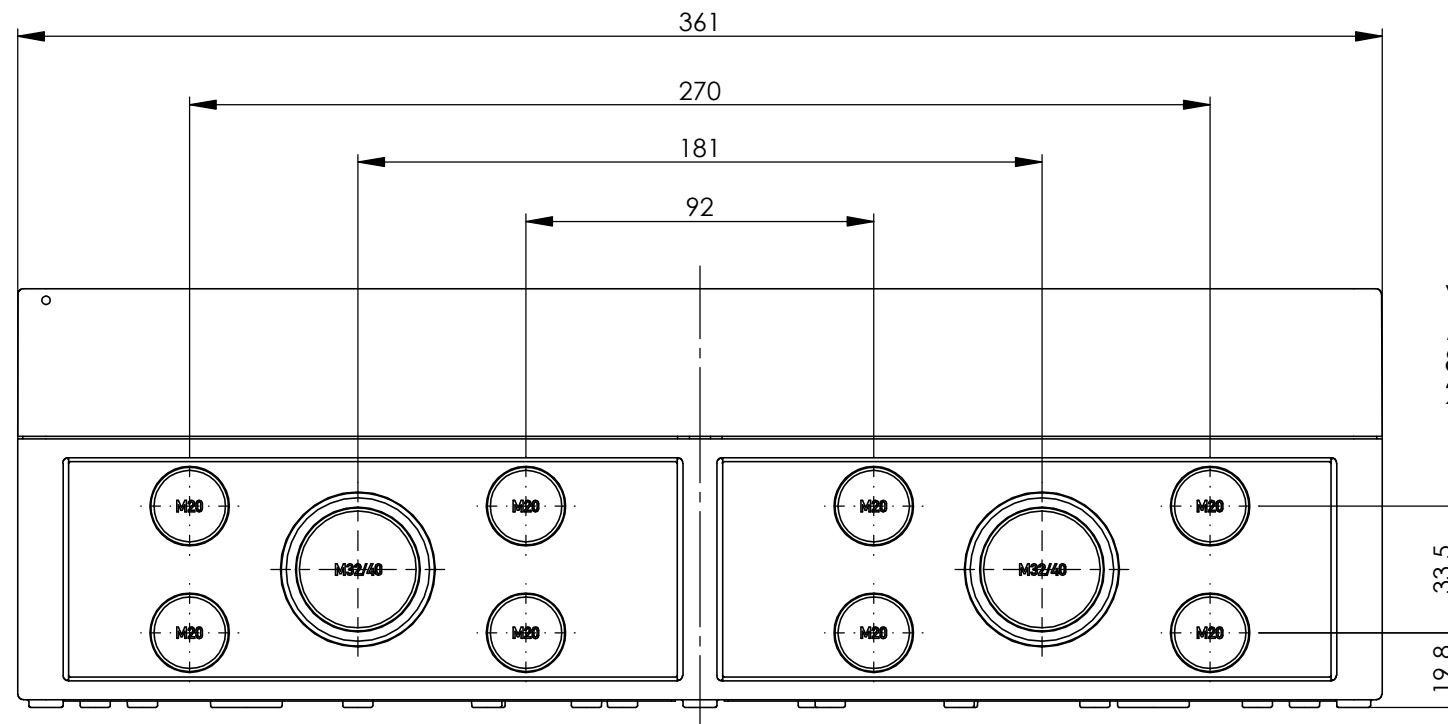

Vorprägungen/  
*knockouts:*  
 8x M20  
 2x M32/40

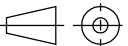
2010	Datum/ date	Name/ name	Gewicht/ weight [g]	Oberfläche/ surface [mm²]	Werkstoff/ material	Gehäuse/ <i>Housing</i> - PS (Polystyrol)
gez./ drawn	08.12.	SW	-	-	Oberfläche/ finish	
gepr./ appr.	08.12.10	KR				
Norm/ stand.						
Maßstab/ scale	Benennung/ title					
	LWL-Spleißbox IP66-M-V mit Befestigungsblech 360×254×111 <i>FO-Splice Box IP66-M-V with mounting plate</i>					
untl. Maße/ dim. without tolerances according to	Unter./doc. type	Zeichnungsnr./ drawing no.				
	K	H02050A0231				
Änd./ rev. index	Änderungsmittlung/ revision code	Datum/ date	Name/ name	DIN 7168 mittel		
				Ersatz für/ replaces		
				 <b>Telegärtner</b> GERÄTEBAU GMBH		
				 Maße/ dimensions: mm		
				Original : DIN A3 infor-089574		
				Blatt/ sheet 2 von/ of 2		