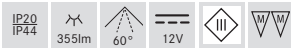
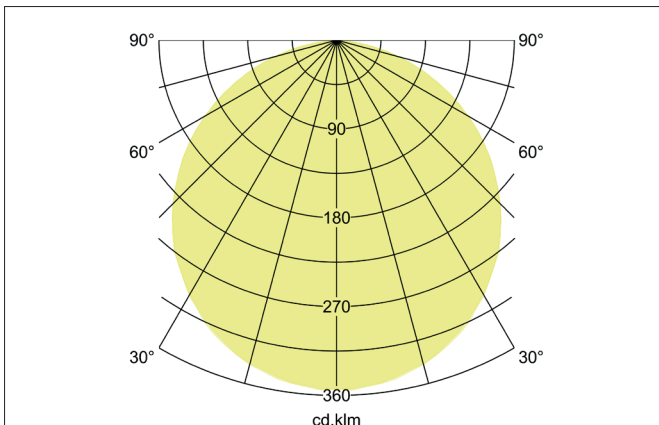
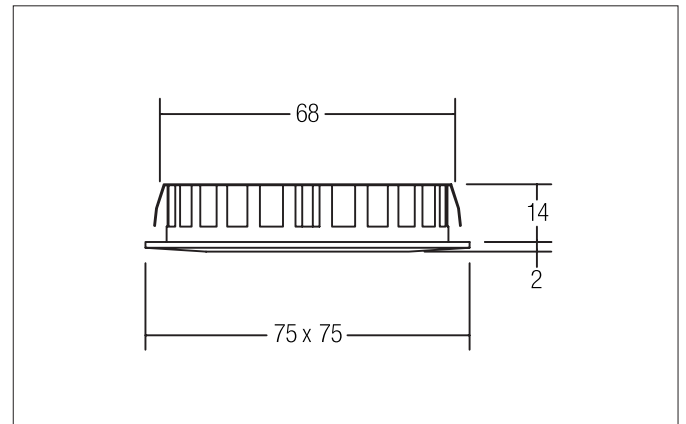

SINCINDA MIDI-S LED recessed downlight, IP44

Article no. 12128023

Light.
For Generations.**Tender**

LED recessed downlight, IP44, Square. Toolless ceiling installation by leaf spring. Ceiling cut-out Ø 68 mm, Installation depth 14 mm, Length 75 mm, Width 75 mm, Weight 0,108 kg, with rotationssymmetrical, deep, wide distributed light intensity. optimal light distribution due to a plastic, opal cover. Luminous flux 355 lm, Power 1 x 4,5 W, System Efficiency 79 lm/W, Light colour warm white, Correlated color temprature (CCT) 2.900 K, Colour rendering index CRI 85, Housing material: Die-cast aluminium / Plastic, Colour: Chrome, Permissible ambient temperature (ta): -20 °C - +25 °C, Protection class (EN 61140): III, Degree of protection (DIN EN 60529): IP44 when installing in closed ceilings. For connection to an external driver, which is not included in the scope of delivery of the luminaire. Depending on driver dimmable.

Article data	
Article no.	12128023
GTIN	4250047702122
Series name	SINCINDA MIDI-S
Short description	LED recessed downlight, IP44
Material	Die-cast aluminium / Plastic
Colour	Chrome
Type of surface	Glossy
Shape	Square
Built-in diameter	68 mm
Installation depth	14 mm
Length	75 mm
Width	75 mm
Hight	2 mm
Scope of delivery	Including 2,000 mm connecting cable
Weight	0.108 kg

SINCINDA MIDI-S LED recessed downlight, IP44

Article no. 12128023

Light.
For Generations.

Lighting technology	
Colour temperature	2.900 K
Light colour	White
Light output	Direct
Luminous flux	355 lm
System efficiency	79 lm/W
Colour rendering	CRI 85
Reflector	Without
Beam angle	60°
Light sharing	Symmetric

Operating technology of the luminaire	
System output	4.5 W
Voltage type	DC
DC nominal voltage max	12 V
Lamp	LED
Protection class	III
Degree of protection	IP44
Schutzart deckenseitig	IP20
Dimmable	Depending on type of control gear
Control	Depending on driver
Bulb change possible	The light source of this luminaire may only be replaced by the manufacturer or a service technician commissioned by him or a similarly qualified person.





Mounting technology	
Mounting method	Recessed mounting
Place of installation	Ceiling-mounted
Adjustability	Not adjustable
stamp	MM
Further references	No cover with thermal insulation material
Material cover	Plastic, opal

Packing data	
Gross weight	0.123 kg
Length of packaging	85 mm
Packaging width	43 mm
Packaging height	84 mm
Disposal at end of life	This product must not be disposed of with household waste. You are obliged, to dispose of such electrical waste separately. By disposing of electrical waste and other old or defective electronics separately, you support recycling or other forms of re-use. In that way you help to take care and to avoid that harmful substances get into the environment.

SINCINDA MIDI-S LED recessed downlight, IP44

Article no. 12128023

Light.
For Generations.

Accessories	
	Article no.: 17106000 LED power supply 12 V DC, on/off switchable Power: 1 - 15 W Dimensions: 105 mm x 49 mm x 18 mm
	Article no.: 17110000 LED power supply 12 V DC, on/off switchable Power: 1 - 30 W Dimensions: 185 mm x 48 mm x 20 mm
	Article no.: 17107000 6-way distributor 12 V DC for 17106/17110 Leistung: 30 W
	Article no.: 17108000 Extension cable 12 V DC for 17106/17110/17107