

SCHALTBILDER

EZF 40/6 B

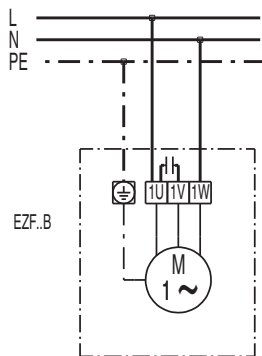
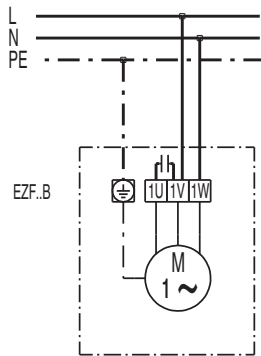

SCHALTBILDER

EZF 40/6 B

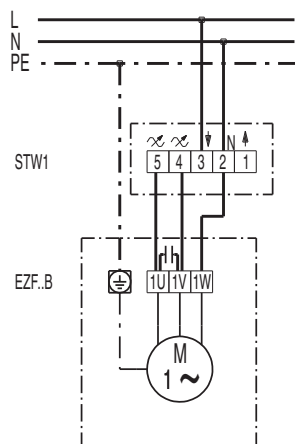
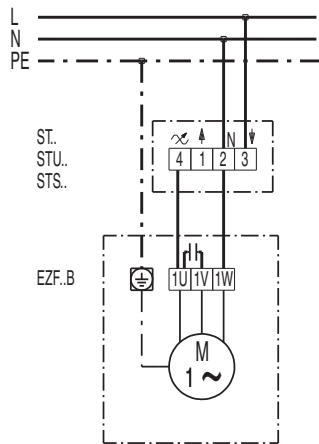

EZF 40/6 B

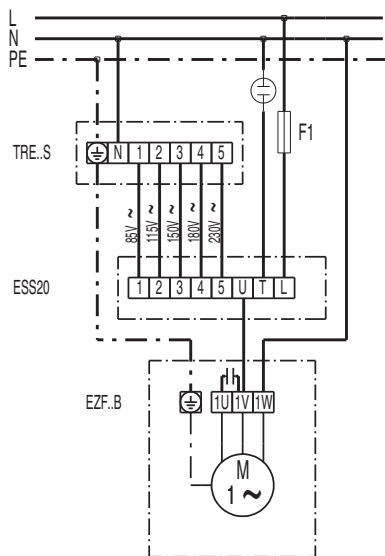
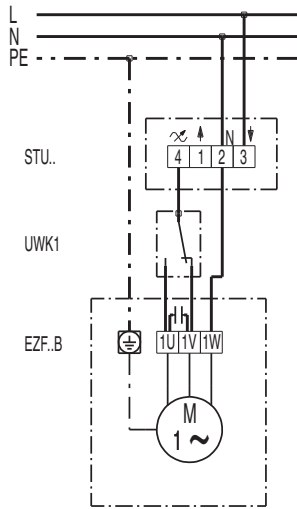

SCHALTBILDER

EZF 40/6 B

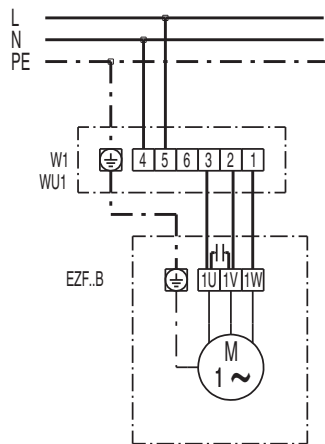
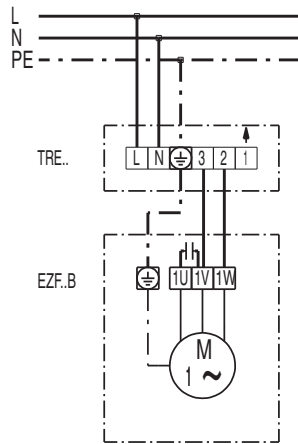

SCHALTBILDER

EZF 40/6 B

