

Matric-FX

Recessed mounted light line, mounting brackets incl - Direct light distribution

Article code: LFXLEE-840E-L1733-A

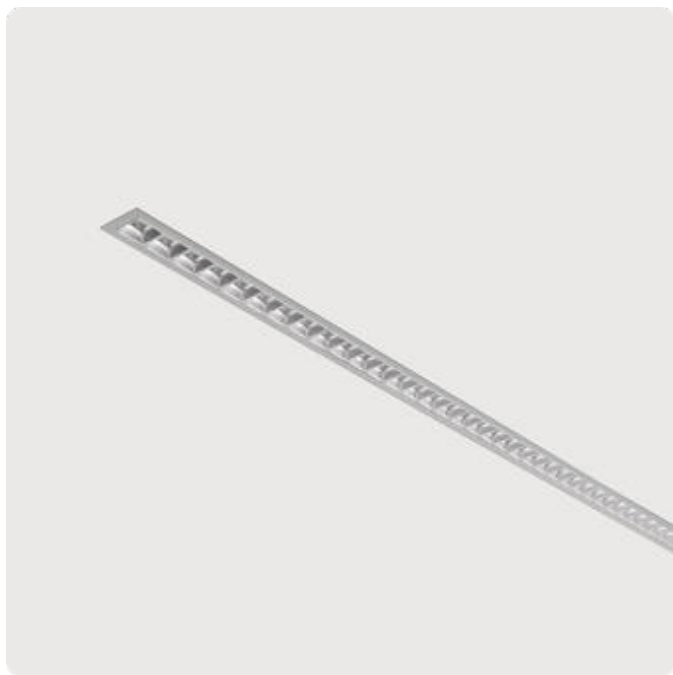

Illustrations may only be similar and serve as an orientation.

Matric-FX. LED. Recessed mounted light line with surrounding frame for installation in sawn wall and ceiling with cut-out openings. Mounting brackets included. Luminaire body made of high-quality aluminum profile. Surface finish Silver Anodised. Direct only light distribution. Colour temperature: 4000K (Cool White). Colour Rendering Index (CRI): >80. Lens Louvre: precision lenses with louvre for wide and symmetrical light distribution. High glare limitation, compatible for office applications. UGR<=19.

Reflector: Satin Silver. Switchable. LxWxH (rectangular). L=1733mm. W=50mm. H=65mm. Low-power current. 2910lm. 22W. 3,4kg. Binning initial <= MacAdam 3. IP20. Protection class I. CE, UKCA marking. IK02. 220-240V. 50-60 Hz. RG0 (EN62471). Luminous flux reduction up to 0,2%/1.000 operating hours. Nominal failure rate: 0,2%/1.000 operating hours. L90B10 (tq 25°C) = 50.000h. 5 years warranty. Manufacturer: Lightnet GmbH, ISO 9001:2015 and 50001:2018 certified.

Matric-FX

Recessed mounted light line, mounting brackets incl - Direct light distribution

Article code: LFXLEE-840E-L1733-A

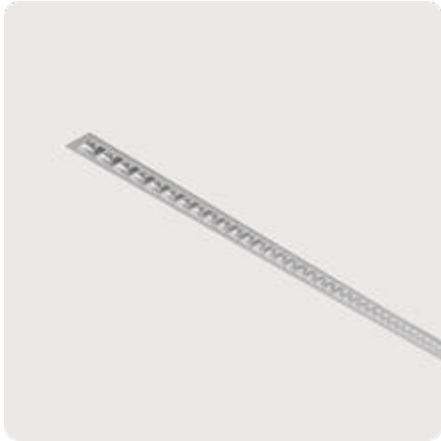

Customer / Project: _____

Note: _____

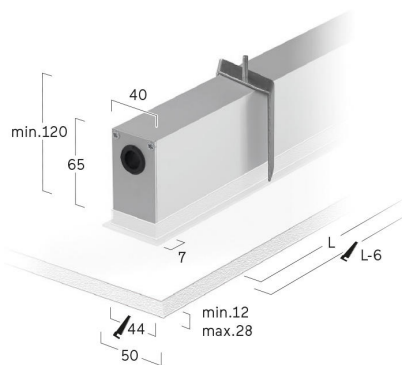
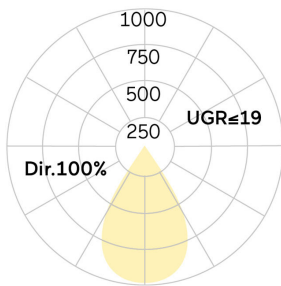

Productname	Matric-FX
Lamp	LED
Installation Type	Recessed mounted light line, mounting brackets incl
Surface finish	Silver Anodised
Light characteristics	Direct light distribution
Colour temperature	4000K
Colour Rendering Index (CRI)	CRI>80
Optical system	Lens Louvre
Reflector Colour Inside	Reflector: Satin Silver
Control	Switchable
Length L/Diameter D (mm)	L=1733mm
Width W (mm)	W=50mm
Height H (mm)	H=65mm
Current/Power	Low-Power
Luminous Flux	2910lm
Power consumption	22W
Degree of protection	IP20
LED lifetime	L90B10 (tq 25°C) = 50.000h
UGR	UGR<=19
Photometric code	8 40 / 3 3 9
Photobiological class	RG0 (EN62471)
Indoor/Outdoor	Indoor: ta [ambient] max. 25°C
Weight (kg)	3,4kg

