

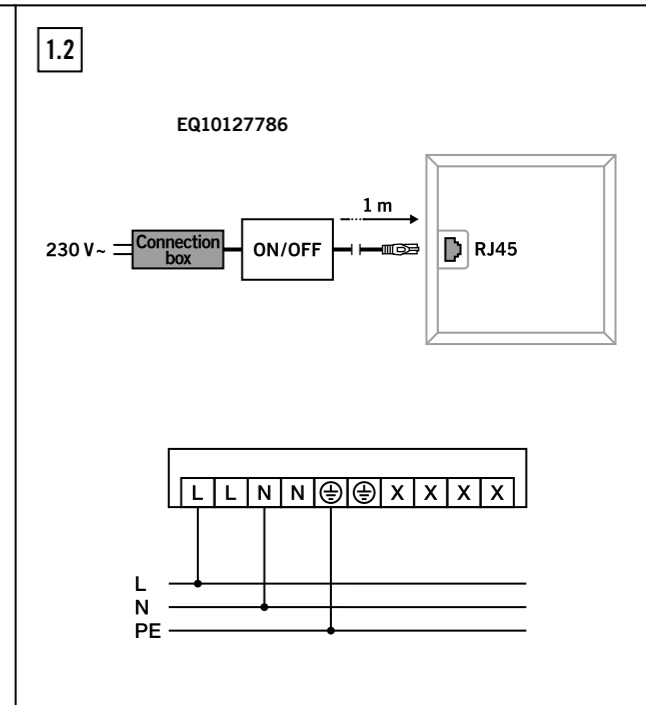

Technical data for specific products can be found at www.esylux.com/products

Item no.	Product name	X mm	Y mm	Z mm		
EQ10127755	DRIVER SET TW 38W RJ45 WAGO WINSTA DALI DT8	215	70	31		
EQ10127762	DRIVER SET 30W RJ45 WAGO WINSTA DALI	103	68	30		
EQ10127779	DRIVER SET 30W RJ45 WAGO WINSTA	132	45	30		
EQ10127786	DRIVER SET 30W RJ45	132	45	30		

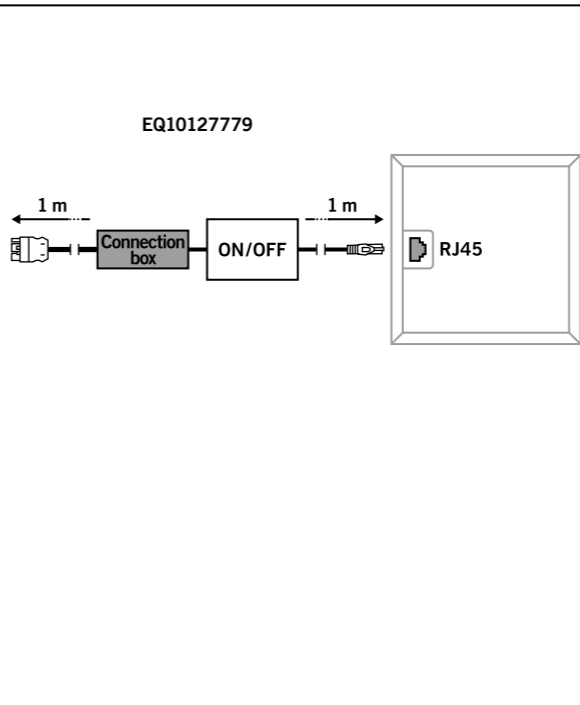
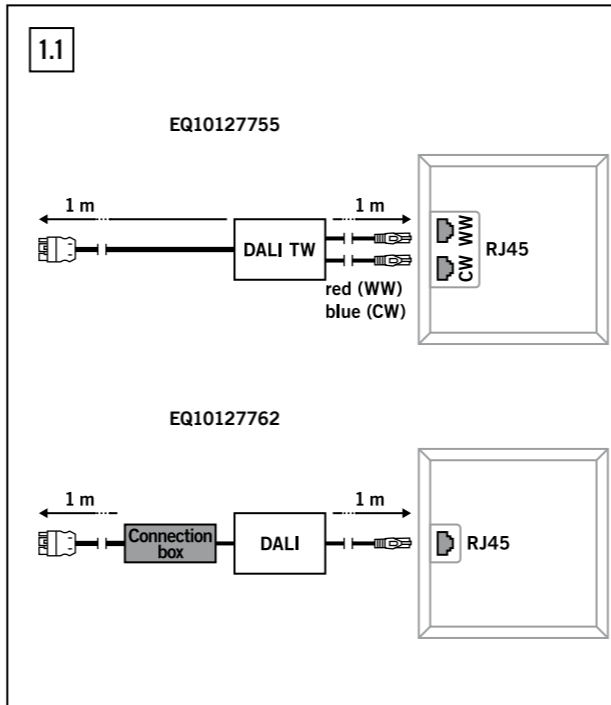

DE KURZANLEITUNG

GEFAHR!

Lebensgefahr durch elektrischen Schlag!

- Die Installation darf nur von Elektroinstallateuren oder Elektrofachkräften unter Berücksichtigung der landesspezifischen Vorschriften erfolgen
- Vor Montage/Demontage Netzspannung freischalten

1 Bestimmungsgemäße Verwendung

Das LED-Treiber Set ist für ESYLUX Satellite LED-Leuchten konzipiert. Die Anwendung ist in abgehängten Decken für den Innenbereich bestimmt.

EQ10127755 – DRIVER SET TW 38W RJ45 WAGO WINSTA DALI DT8 Plug & Play LED-Treiber Set DALI TW.

Für ESYLUX Satellite Tunable White LED-Leuchten.

- Primärseitig am Treiber angeschlossen: 1 m schwarzes Kabel mit 5-poligem schwarz/blauem Stecker WAGO WINSTA 770
- Sekundärseitig am Treiber angeschlossen: 1 m blaues Kabel (kaltweißer Kanal) und 1 m rotes Kabel (warmweißer Kanal) mit RJ45-Stecker

EQ10127762 – DRIVER SET 30W RJ45 WAGO WINSTA DALI Plug & Play LED-Treiber Set DALI.

Für ESYLUX Satellite LED-Leuchten mit konstanter Lichtfarbe.

- Primärseitig am Treiber angeschlossen: 150 mm weißes Kabel an eine Anschlussbox und daran 1 m schwarzes Kabel mit 5-poligem schwarz/blauem Stecker WAGO WINSTA 770
- Sekundärseitig am Treiber angeschlossen: 1 m blaues Kabel mit RJ45-Stecker

EQ10127779 – DRIVER SET 30W RJ45 WAGO WINSTA Plug & Play LED-Treiber Set ON/OFF.

Für ESYLUX Satellite LED-Leuchten mit konstanter Lichtfarbe.

- Primärseitig am Treiber angeschlossen: 150 mm weißes Kabel an eine Anschlussbox und daran 1 m schwarzes Kabel mit 3-poligem schwarzem Stecker WAGO WINSTA 770
- Sekundärseitig am Treiber angeschlossen: 1 m langes blaues Kabel mit RJ45-Stecker

EQ10127786 – DRIVER SET 30W RJ45

LED-Treiber Set ON/OFF.

Für ESYLUX Satellite LED-Leuchten mit konstanter Lichtfarbe.

- Primärseitig am Treiber angeschlossen: 150 mm weißes Kabel mit 3-poliger Steckklemme, 2,5 mm³ in einer Anschlussbox mit Zugentlastung
- Sekundärseitig am Treiber angeschlossen: 1 m langes blaues Kabel mit RJ45-Stecker

Technische Daten

	EQ10127755 DRIVER SET TW 38W RJ45 WAGO WINSTA DALI DT8	EQ10127762 DRIVER SET 30W RJ45 WAGO WINSTA DALI	EQ10127779 DRIVER SET 30W RJ45 WAGO WINSTA	EQ10127786 DRIVER SET 30W RJ45
Anschluss	WAGO, RJ45	WAGO, RJ45	WAGO, RJ45	0,5 - 2,5 mm ² , RJ45
Gewicht	460 g	440 g	340 g	240 g
Relative Luftfeuchte	max. 80 %, nicht kondensierend	10 - 90 %, nicht kondensierend	10 - 90 %, nicht kondensierend	10 - 90 %, nicht kondensierend
Farbe	schwarz	schwarz/weiß	schwarz/weiß	schwarz/weiß
Nennspannung	220 - 240 V ~ / 50 - 60 Hz	200 - 240 V ~ / 50 - 60 Hz	200 - 240 V ~ / 50 - 60 Hz	200 - 240 V ~ / 50 - 60 Hz
Standby-Verbrauch	< 0,25 W	< 0,5 W	< 0,5 W	< 0,5 W
Leistungsaufnahme	35 W	34 W	30 W	30 W

GB SHORT INSTRUCTION

DANGER!

Risk of fatal injury from electric shock!

- Installation may be performed only by an electrical installation technician or a trained electrician, taking country-specific regulations into account
- Switch off the mains voltage prior to assembly/disassembly

1 Intended use

The LED driver set is designed for ESYLUX Satellite LED lights. It is intended for use in suspended ceilings indoors.

EQ10127755 – DRIVER SET TW 38W RJ45 WAGO WINSTA DALI DT8 DALI TW plug-and-play LED driver set.

For ESYLUX Satellite Tunable White LED lights.

- Connected to the driver on the primary side: 1-m black cable with WAGO WINSTA 770 5-pin black/blue plug
- Connected to the driver on the secondary side: 1-m blue cable (cold-white channel) and 1-m red cable (warm-white channel) with RJ45 plug

EQ10127762 – DRIVER SET 30W RJ45 WAGO WINSTA DALI DALI plug-and-play LED driver set.

For ESYLUX Satellite LED lights with constant light colour.

- Connected to the driver on the primary side: 150-mm white cable to a junction box plus 1-m black cable with WAGO WINSTA 770 5-pin black/blue plug
- Connected to the driver on the secondary side: 1-m blue cable with RJ45 plug

EQ10127779 – DRIVER SET 30W RJ45 WAGO WINSTA ON/OFF plug-and-play LED driver set.

For ESYLUX Satellite LED lights with constant light colour.

- Connected to the driver on the primary side: 150-mm white cable to a junction box plus 1-m black cable with WAGO WINSTA 770 3-pin black plug
- Connected to the driver on the secondary side: 1-m blue cable with RJ45 plug

EQ10127786 – DRIVER SET 30W RJ45 ON/OFF LED driver set.

For ESYLUX Satellite LED lights with constant light colour.

- Connected to the driver on the primary side: 150-mm white cable with a 3-pin push terminal, 2,5 mm³, in a junction box with cord grips
- Connected to the driver on the secondary side: 1-m blue cable with RJ45 plug

Technical data

	EQ10127755 DRIVER SET TW 38W RJ45 WAGO WINSTA DALI DT8	EQ10127762 DRIVER SET 30W RJ45 WAGO WINSTA DALI	EQ10127779 DRIVER SET 30W RJ45 WAGO WINSTA	EQ10127786 DRIVER SET 30W RJ45
Connection	WAGO, RJ45	WAGO, RJ45	WAGO, RJ45	0.5 - 2.5 mm ² , RJ45
Weight	460 g	440 g	340 g	240 g
Relative humidity	max. 80 %, non-condensing	10 - 90 %, non-condensing	10 - 90 %, non-condensing	10 - 90 %, non-condensing
Colour	Black	black/white	black/white	black/white
Nominal voltage	220 - 240 V ~ / 50 - 60 Hz	220 - 240 V ~ / 50 - 60 Hz	220 - 240 V ~ / 50 - 60 Hz	220 - 240 V ~ / 50 - 60 Hz
Standby consumption	< 0.25 W	< 0.5 W	< 0.5 W	< 0.5 W
Power consumption	35 W	34 W	30 W	30 W

Installation type/location

Recessed/ceiling

Included in delivery

1 x LED driver set

2 Connection

Connect the following items as shown in figure (1.1).

EQ10127755 – DRIVER SET TW 38W RJ45 WAGO WINSTA DALI DT8

EQ10127762 – DRIVER SET 30W RJ45 WAGO WINSTA DALI

EQ10127779 – DRIVER SET 30W RJ45 WAGO WINSTA

Connect the following items as shown in wiring diagram (1.2).

EQ10127786 – DRIVER SET 30W RJ45

L External conductor, 230 V~

N Neutral conductor

Earth conductor

3 Disposal/warranty

This device must not be disposed of as unsorted residual waste. Used devices must be disposed of correctly. Contact your local town council for more information.

The ESYLUX manufacturer's warranty can be found online at www.esylux.com.

Technical and design features may be subject to change.

FR MODE D'EMPLOI RAPIDE

DANGER !

Danger de mort par électrocution !

- L'installation doit impérativement être effectuée par des installateurs professionnels ou des spécialistes de l'électronique conformément aux normes et prescriptions locales en vigueur
- Avant d'installer ou de désinstaller le produit, coupez le courant

1 Conformité d'utilisation

Ce kit de pilotes LED est conçu pour les luminaires à LED Satellite ESYLUX. Il est destiné à être utilisé en intérieur sur des plafonds suspendus.

EQ10127755 – DRIVER SET TW 38W RJ45 WAGO WINSTA DALI DT8

Kit de pilotes Plug & Play LED DALI TW.

Pour luminaires à LED Satellite ESYLUX Tunable White.

- Connexion au pilote côté primaire : Câble noir de 1 m avec fiche à 5 pôles noir/bleu WAGO WINSTA 770
- Connexion au pilote côté secondaire : Câble bleu de 1 m (canal blanc froid) et câble rouge de 1 m (canal blanc chaud) avec fiche RJ45

EQ10127762 – DRIVER SET 30W RJ45 WAGO WINSTA DALI

Kit de pilotes Plug & Play LED DALI.

Pour luminaires à LED Satellite ESYLUX avec une couleur d'éclairage constante.

- Connexion au pilote côté primaire : Câble blanc de 150 mm à une boîte de branchements, et ensuite câble noir de 1 m avec une fiche 5 pôles noir/bleu WAGO WINSTA 770
- Connexion au pilote côté secondaire : Câble bleu de 1 m avec fiche RJ45

EQ10127779 – DRIVER SET 30W RJ45 WAGO WINSTA

Kit de pilotes Plug & Play LED ON/OFF.

Pour luminaires à LED Satellite ESYLUX avec une couleur d'éclairage constante.

- Connexion au pilote côté primaire : Câble blanc de 150 mm à une boîte de branchements, et ensuite câble noir de 1 m avec une fiche tripolaire noire WAGO WINSTA 770
- Connexion au pilote côté secondaire : Câble bleu de 1 m avec fiche RJ45

Caractéristiques techniques

	EQ10127755 DRIVER SET TW 38 W RJ45 WAGO WINSTA DALI DT8	EQ10127762 DRIVER SET 30 W RJ45 WAGO WINSTA DALI	EQ10127779 DRIVER SET 30 W RJ45 WAGO WINSTA	EQ10127786 DRIVER SET 30 W RJ45
Raccordement	WAGO, RJ45	WAGO, RJ45	WAGO, RJ45	0,5 - 2,5 mm ² , RJ45
Poids	460 g	440 g	340 g	240 g
Taux d'humidité relative	max. 80 %, sans condensation	10 - 90 %, sans condensation	10 - 90 %, sans condensation	10 - 90 %, sans condensation
Coloris	noir	noir/blanc	noir/blanc	noir/blanc
Tension nominale	220 - 240 V ~ / 50 - 60 Hz	220 - 240 V ~ / 50 - 60 Hz	220 - 240 V ~ / 50 - 60 Hz	220 - 240 V ~ / 50 - 60 Hz
Consommation en veille	< 0,25 W	< 0,5 W	< 0,5 W	< 0,5 W
Consommation	35 W	34 W	30 W	30 W

EQ10127786 – DRIVER SET 30W RJ45

Kit de pilotes LED ON/OFF.

Pour luminaires à LED Satellite ESYLUX avec une couleur d'éclairage constante.

- Connexion au pilote côté primaire : Câble blanc de 150 mm avec bornier enfichable tripolaire, 2,5 mm³ dans une boîte de branchements avec dispositif anti-traction
- Connexion au pilote côté secondaire : Câble bleu de 1 m avec fiche RJ45

Type de montage et emplacement d'installation

Intégré au plafond

Éléments inclus

1 x kit de pilotes

2 Raccordement

Le raccordement pour les articles suivants s'effectue conformément aux illustration (1.1).

EQ10127755 – DRIVER SET TW 38W RJ45 WAGO WINSTA DALI DT8

EQ10127762 – DRIVER SET 30W RJ45 WAGO WINSTA DALI

EQ10127779 – DRIVER SET 30W RJ45 WAGO WINSTA

Le raccordement pour l'article suivant s'effectue conformément au schéma électrique (1.2).

EQ10127786 – DRIVER SET 30W RJ45

L Fil externe 230 V~

N Fil neutre

Terre

3 Mise au rebut/garantie

Cet appareil ne doit pas être jeté avec les déchets non triés. Les propriétaires d'équipements électriques ou électroniques usagés ont en effet l'obligation légale de les déposer dans un centre de collecte sélective. Informez-vous auprès de votre municipalité sur les possibilités de recyclage.

La garantie fabricant ESYLUX est disponible sur Internet à l'adresse www.esylux.com.

Sous réserve de modifications techniques et esthétiques.

ESYLUX

ESYLUX GmbH | An der Strusbek 40
22926 Ahrensburg /Germany
info@esylux.com | www.esylux.com

MA01719600

IP20



0 °C ... +40 °C



Technical data for specific products can be found at www.esylux.com/products

Item no.	Product name	X mm	Y mm	Z mm		
EQ10127755	DRIVER SET TW 38W RJ45 WAGO WINSTA DALI DT8	215	70	31		
EQ10127762	DRIVER SET 30W RJ45 WAGO WINSTA DALI	103	68	30		
EQ10127779	DRIVER SET 30W RJ45 WAGO WINSTA	132	45	30		
EQ10127786	DRIVER SET 30W RJ45	132	45	30		

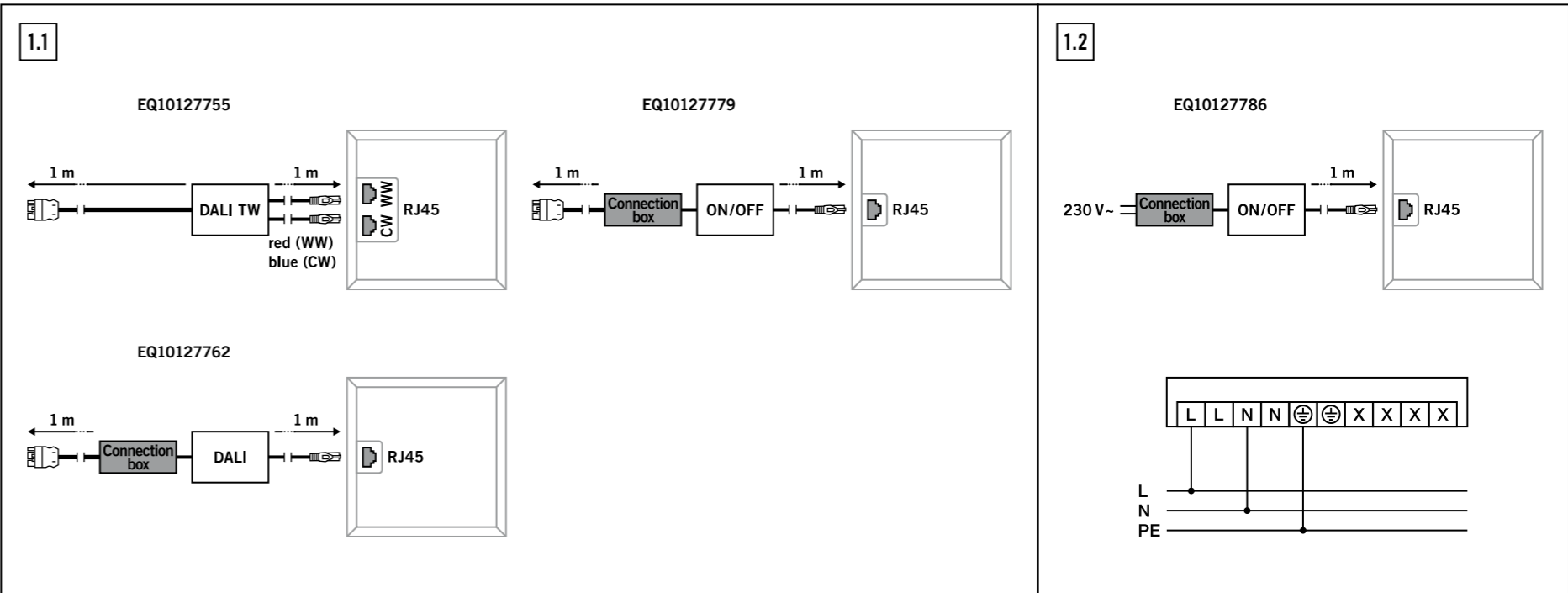

NL KORTE HANDLEIDING

GEVAAR!

Levensgevaar door elektrische schok!

- De installatie mag uitsluitend door elektro-installateurs of elektriciens worden uitgevoerd, met inachtneming van de landspecifieke voorschriften
- Vóór montage/demontage de netspanning uitschakelen

1 Gebruik in overeenstemming met het gebruiksdoel

De LED-driverset is ontworpen voor ESYLUX Satellite LED-armaturen. De toepassing is in verlaagde plafonds voor binnenshuis bestemd.

EQ10127755 – DRIVER SET TW 38W RJ45 WAGO WINSTA DALI DT8
Plug & Play LED-driverset DALI TW.

Voor ESYLUX Satellite Tunable White LED-armaturen.

- Aan primaire zijde op de driver aangesloten: 1 m zwarte kabel met 5-polige zwart-blauwe stekker WAGO WINSTA 770
- Aan secundaire zijde op de driver aangesloten: 1 m blauwe kabel (koudwit kanaal) en 1 m rode kabel (warmwit kanaal) met RJ45-stekker

EQ10127762 – DRIVER SET 30W RJ45 WAGO WINSTA DALI
Plug & Play LED-driverset DALI.

Voor ESYLUX Satellite LED-armaturen met constante lichtkleur.

- Aan primaire zijde op de driver aangesloten: 150 mm witte kabel op een aansluitbox en daarop 1 m zwarte kabel met 5-polige zwart-blauwe stekker WAGO WINSTA 770
- Aan secundaire zijde op de driver aangesloten: 1 m blauwe kabel met RJ45-stekker

EQ10127779 – DRIVER SET 30W RJ45 WAGO WINSTA

Plug & Play LED-driverset ON/OFF.

Voor ESYLUX Satellite LED-armaturen met constante lichtkleur.

- Aan primaire zijde op de driver aangesloten: 150 mm witte kabel op een aansluitbox en daarop 1 m zwarte kabel met 3-polige zwarte stekker WAGO WINSTA 770
- Aan secundaire zijde op de driver aangesloten: 1 m lange blauwe kabel met RJ45-stekker

EQ10127786 – DRIVER SET 30W RJ45

LED-driverset ON/OFF.

Voor ESYLUX Satellite LED-armaturen met constante lichtkleur.

- Aan primaire zijde op de driver aangesloten: 150 mm witte kabel met 3-polige insteekklem, 2,5 mm³ in een aansluitbox met trektoelasting
- Aan secundaire zijde op de driver aangesloten: 1 m lange blauwe kabel met RJ45-stekker

Technische gegevens

	EQ10127755 DRIVER SET TW 38W RJ45 WAGO WINSTA DALI DT8	EQ10127762 DRIVER SET 30W RJ45 WAGO WINSTA DALI	EQ10127779 DRIVER SET 30W RJ45 WAGO WINSTA	EQ10127786 DRIVER SET 30W RJ45
Aansluiting	WAGO, RJ45	WAGO, RJ45	WAGO, RJ45	0,5 - 2,5 mm², RJ45
Gewicht	460 g	440 g	340 g	240 g
Relatieve luchtvochtigheid	max. 80 %, niet-condenserend	10 - 90 %, niet-condenserend	10 - 90 %, niet-condenserend	10 - 90 %, niet-condenserend
Kleur	zwart	zwart/wit	zwart/wit	zwart/wit
Nominale spanning	220-240 V ~ / 50-60 Hz	200-240 V ~ / 50-60 Hz	200-240 V ~ / 50-60 Hz	200-240 V ~ / 50-60 Hz
Stand-byverbruik	< 0,25 W	< 0,5 W	< 0,5 W	< 0,5 W
Opgenomen vermogen	35 W	34 W	30 W	30 W

DK KORT VEJLEDNING

FARE!

Livsfare på grund af elektrisk stød!

- Installationen må kun foretages af elinstallatører eller elektriker under overholdelse af nationale installationsforskrifter
- Før montering/afmontering skal forsyningssspændingen slås fra

1 Tilsigtet anvendelse

LED-driversættet er beregnet til ESYLUX Satellite LED-lamper. Beregnet til indendørs anvendelse i sænkede lofter.

EQ10127755 – DRIVER SET TW 38W RJ45 WAGO WINSTA DALI DT8
Plug & Play LED-driversæt DALI TW.

Til ESYLUX Satellite Tunable White LED-lamper.

- Primærttilsluttet til driveren: 1 m sort kabel med 5-polet sort/blåt stik WAGO WINSTA 770
- Sekundærttilsluttet til driveren: 1 m blåt kabel (koldhvid kanal) og 1 m rødt kabel (varmhvid kanal) med RJ45-stik

EQ10127762 – DRIVER SET 30W RJ45 WAGO WINSTA DALI

Plug & Play LED-driversæt DALI.

Til ESYLUX Satellite LED-lamper med konstant lysfarve.

- Primærttilsluttet til driveren: 150 mm hvidt kabel til en samledåse og dertil 1 m sort kabel med 5-polet sort stik WAGO WINSTA 770
- Sekundærttilsluttet til driveren: 1 m blåt kabel med RJ45-stik

EQ10127779 – DRIVER SET 30W RJ45 WAGO WINSTA

Plug & Play LED-driversæt ON/OFF.

Til ESYLUX Satellite LED-lamper med konstant lysfarve.

- Primærttilsluttet til driveren: 150 mm hvidt kabel til en samledåse og dertil 1 m sort kabel med 3-polet sort stik WAGO WINSTA 770
- Sekundærttilsluttet til driveren: 1 m langt blåt kabel med RJ45-stik

EQ10127786 – DRIVER SET 30W RJ45

LED-driversæt ON/OFF.

Til ESYLUX Satellite LED-lamper med konstant lysfarve.

- Primærttilsluttet til driveren: 150 mm hvidt kabel med 3-polet stikklemme, 2,5 mm³ i en tilslutningsboks med trækafkastning
- Sekundærttilsluttet til driveren: 1 m langt blåt kabel med RJ45-stik

Tekniske data

	EQ10127755 DRIVER SET TW 38W RJ45 WAGO WINSTA DALI DT8	EQ10127762 DRIVER SET 30W RJ45 WAGO WINSTA DALI	EQ10127779 DRIVER SET 30W RJ45 WAGO WINSTA	EQ10127786 DRIVER SET 30W RJ45
Tilslutning	WAGO, RJ45	WAGO, RJ45	WAGO, RJ45	0,5 - 2,5 mm², RJ45
Vægt	460 g	440 g	340 g	240 g
Relativ luftfugtighed	maks. 80 %, ikke-kondenserende	10 - 90 %, ikke-kondenserende	10 - 90 %, ikke-kondenserende	10 - 90 %, ikke-kondenserende
Farve	sort	sort/hvid	sort/hvid	sort/hvid
Nominal spænding	220-240 V ~ / 50-60 Hz	200-240 V ~ / 50-60 Hz	200-240 V ~ / 50-60 Hz	200-240 V ~ / 50-60 Hz
Standby-forbrug	< 0,25 W	< 0,5 W	< 0,5 W	< 0,5 W
Effektforbrug	35 W	34 W	30 W	30 W

Monteringstype/-sted

Indbygning/loft

Leverancen omfatter

1 x LED-driversæt

2 Tilslutning

Illustrationerne **(1.1)** viser tilslutningen for følgende artikler.

EQ10127755 – DRIVER SET TW 38W RJ45 WAGO WINSTA DALI DT8
EQ10127762 – DRIVER SET 30W RJ45 WAGO WINSTA DALI
EQ10127779 – DRIVER SET 30W RJ45 WAGO WINSTA

Tilslutningsplanen **(1.2)** viser tilslutningen for følgende artikler.

EQ10127786 – DRIVER SET 30W RJ45

L Ydre leder 230 V ~

N Nulleleder

Beskyttelsesleder

3 Bortskaffelse/garanti

Dette apparat må ikke bortskaffes med usorteret husholdningsaffald. Ejere af brugt udstyr er i henhold til loven forpligtet til at bortskaffe dette udstyr fagligt korrekt. I din kommune kan du få yderligere informationer.

Du kan finde ESYLUX-producentgarantien på internettet på www.esylux.com.

Der tages forbehold for tekniske og optiske ændringer.

SE KORTFATTAD BRUKSANVISNING

VARNING!

Livsfara, risk för elektrisk stöt!

- Installation får endast utföras av elinstallatörer och behöriga elektriker under iakttagande av nationella föreskrifter
- Innan produkten monteras/tas bort ska nätspänningen kopplas från

1 Ändamålsenlig användning

LED-drivenhetssatsen är utformad för ESYLUX Satellite LED-armaturer. Avsedd att användas i undertak inomhus.

EQ10127755 – DRIVER SET TW 38W RJ45 WAGO WINSTA DALI DT8
Plug and play LED-drivenhetssats DALI TW.

För ESYLUX Satellite Tunable White LED-armaturer.

- Anslutet på primärsidan på drivenheten: 1 m svart kabel med 5-polig svart/blå stickkontakt WAGO WINSTA 770
- Anslutet på sekundärsidan på drivenheten: 1 m blå kabel (kallvit kanal) och 1 m röd kabel (varmvit kanal) med RJ45-kontakt

EQ10127762 – DRIVER-SATS 30W RJ45 WAGO WINSTA DALI

Plug and play LED-drivenhetssats DALI.

För ESYLUX Satellite LED-armaturer med konstant ljusfärg.

- Anslutet på primärsidan på drivenheten: 150 mm vit kabel till en kopplingsdosas och till denna 1 m svart kabel med 5-polig svart/blå stickkontakt WAGO WINSTA 770
- Anslutet på sekundärsidan på drivenheten: 1 m blå kabel med RJ45-kontakt

EQ10127779 – DRIVER-SATS 30W RJ45 WAGO WINSTA

Plug and play LED-drivenhetssats ON/OFF.

För ESYLUX Satellite LED-armaturer med konstant ljusfärg.

- Anslutet på primärsidan på drivenheten: 150 mm vit kabel till en kopplingsdosas och till denna 1 m svart kabel med 3-polig svart stickkontakt WAGO WINSTA 770
- Anslutet på sekundärsidan på drivenheten: 1 m lång blå kabel med RJ45-kontakt

EQ10127786 – DRIVER-SATS 30W RJ45

LED-drivenhetssats PÅ/AV.

För ESYLUX Satellite LED-armaturer med konstant ljusfärg.

- Anslutet på primärsidan på drivenheten: 150 mm vit kabel med 3-polig snabbanslutning, 2,5 mm³ i en kopplingsdosas med dragavlastning
- Anslutet på sekundärsidan på drivenheten: 1 m lång blå kabel med RJ45-kontakt

Tekniska uppgifter

	EQ10127755 DRIVER-SATS TW 38W RJ45 WAGO WINSTA DALI DT8	EQ10127762 DRIVER-SATS 30W RJ45 WAGO WINSTA DALI	EQ10127779 DRIVER-SATS 30W RJ45 WAGO WINSTA	EQ10127786 DRIVER-SATS 30W RJ45
Anslutning	WAGO, RJ45	WAGO, RJ45	WAGO, RJ45	0,5 - 2,5 mm², RJ45
Vikt	460 g	440 g	340 g	240 g
Relativ luftfuktighet	max. 80 %, icke kondenserande	10 - 90 %, icke kondenserande	10 - 90 %, icke kondenserande	10 - 90 %, icke kondenserande
Färg	svart	svart/vit	svart/vit	svart/vit
Märkspänning	220-240 V ~ / 50-60 Hz	200-240 V ~ / 50-60 Hz	200-240 V ~ / 50-60 Hz	200-240 V ~ / 50-60 Hz
Förbrukning i viloläge	< 0,25 W	< 0,5 W	< 0,5 W	< 0,5 W
Effektförbrukning	35 W	34 W	30 W	30 W

Monteringssätt/-plats

Montering/tak

Leveransomfattning

1 x LED-drivenhetssats

2 Anslutning

Anslutningen av följande artikel ska utföras enligt bilden **(1.1)**.

EQ10127755 – DRIVER SET TW 38W RJ45 WAGO WINSTA DALI DT8
EQ10127762 – DRIVER-SATS 30W RJ45 WAGO WINSTA DALI
EQ10127779 – DRIVER-SATS 30W RJ45 WAGO WINSTA

Anslutningen av följande artikel ska utföras enligt kopplingsdiagrammet **(1.2)**.

EQ10127786 – DRIVER-SATS 30W RJ45

L Fasledare 230 V ~

N Neutralledare

Skyddsledare

3 Avfallshantering/garanti

Denna apparat får inte kastas i det osorterade restavfallet. Ägare till gamla apparater är enligt lag skyldiga att avfallshandla denna apparat på sakkunnigt och föreskrivet sätt. Information får du från din stads- eller kommunalförvaltning.



Du hittar ESYLUX tillverkargaranti på Internet under www.esylux.com.

Vi förbehåller oss rätten till tekniska och utseendemässiga ändringar.

ESYLUX

ESYLUX GmbH | An der Strusbek 40
22926 Ahrensburg /Germany
info@esylux.com | www.esylux.com

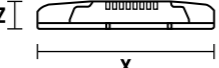
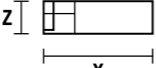
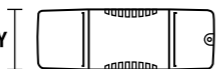
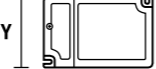
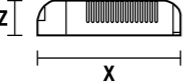
MA01719600

Item no.	Product name	X mm	Y mm	Z mm		
EQ10127755	DRIVER SET TW 38W RJ45 WAGO WINSTA DALI DT8	215	70	31		
EQ10127762	DRIVER SET 30W RJ45 WAGO WINSTA DALI	103	68	30		
EQ10127779	DRIVER SET 30W RJ45 WAGO WINSTA	132	45	30		
EQ10127786	DRIVER SET 30W RJ45	132	45	30		



Technical data for specific products can be found at www.esylux.com/products

FI PIKAOPAS

VAARA!

Sähköisku aiheuttaa hengenvaaran!

- Ainoastaan sähköasentajat tai alan ammattilaiset saavat asentaa tuotteen. Asennuksessa on noudatettava maakohtaisia määräyksiä
- Katkaise verkkojännitte ennen asennusta/purkua

1 Määräystenmukainen käyttö

LED-ohjainsarja on suunniteltu ESYLUX Satellite -LED-valaisimille. Ratkaisu on tarkoitettu sisäkäyttöön asennettavaksi ripustettuihin sisäkattoihin.

EQ10127755 – DRIVER SET TW 38W RJ45 WAGO WINSTA DALI DT8 Plug & Play DALI TW -LED-ohjainsarja.

ESYLUX Satellite Tunable White -LED-valaisimille.

- Kytkentä ohjaimen tuloliitäntään: 1 m:n musta johto, jossa 5-napainen musta/sininen pistoke WAGO WINSTA 770
- Kytkentä ohjaimen lähtöliitäntään: 1 m:n sininen johto (kylmän valkoinen kanava) ja 1 m:n punainen johto (lämpimän valkoinen kanava), joissa RJ45-pistoke

EQ10127762 – DRIVER SET 30W RJ45 WAGO WINSTA DALI Plug & Play DALI -LED-ohjainsarja.

- ESYLUX Satellite -LED-valaisimille, joiden valonväri on vakio.
- Kytkentä ohjaimen tuloliitäntään: 150 mm:n valkoinen johto liitäntärasiaan ja siitä 1 m:n musta johto, jossa 5-napainen musta/sininen pistoke WAGO WINSTA 770
- Kytkentä ohjaimen lähtöliitäntään: 1 m:n sininen johto, jossa RJ45-pistoke

EQ10127779 – DRIVER SET 30W RJ45 WAGO WINSTA

Plug & Play ON/OFF -LED-ohjainsarja.

- ESYLUX Satellite -LED-valaisimille, joiden valonväri on vakio.
- Kytkentä ohjaimen tuloliitäntään: 150 mm:n valkoinen johto liitäntärasiaan ja siitä 1 m:n musta johto, jossa 3-napainen musta pistoke WAGO WINSTA 770
- Kytkentä ohjaimen lähtöliitäntään: 1 m:n sininen johto, jossa RJ45-pistoke

EQ10127786 – DRIVER SET 30W RJ45

ON/OFF-LED-ohjainsarja.

ESYLUX Satellite -LED-valaisimille, joiden valonväri on vakio.

- Kytkentä ohjaimen tuloliitäntään: 150 mm:n valkoinen johto, jossa 3-napainen pistoliitin (2,5 mm³) ja vedonpoistin, liitäntärasiaan
- Kytkentä ohjaimen lähtöliitäntään: 1 m:n sininen johto, jossa RJ45-pistoke

Tekniset tiedot

	EQ10127755 DRIVER SET TW 38W RJ45 WAGO WINSTA DALI DT8	EQ10127762 DRIVER SET 30W RJ45 WAGO WINSTA DALI	EQ10127779 DRIVER SET 30W RJ45 WAGO WINSTA	EQ10127786 DRIVER SET 30W RJ45
Kytkentä	WAGO, RJ45	WAGO, RJ45	WAGO, RJ45	0,5 - 2,5 mm², RJ45
Paino	460 g	440 g	340 g	240 g
Suhteellinen ilmankosteus	enint. 80 %, ei kondensoituva	10 - 90 %, ei kondensoituva	10 - 90 %, ei kondensoituva	10 - 90 %, ei kondensoituva
Väri	musta	musta/valkoinen	musta/valkoinen	musta/valkoinen
Nimellisjännite	220-240 V ~ / 50-60 Hz	200-240 V ~ / 50-60 Hz	200-240 V ~ / 50-60 Hz	200-240 V ~ / 50-60 Hz
Kulutus valmiustilassa	< 0,25 W	< 0,5 W	< 0,5 W	< 0,5 W
Tehontarve	35 W	34 W	30 W	30 W

Asennustapa/-paikka

Uppoasennus/katto

Toimituksen sisältö

1 x LED-ohjainsarja

2 Kytkentä

Seuraavien tuotteiden kytkennät tehdään kuvien **(1.1)** mukaisesti. EQ10127755 – DRIVER SET TW 38W RJ45 WAGO WINSTA DALI DT8 EQ10127762 – DRIVER SET 30W RJ45 WAGO WINSTA DALI EQ10127779 – DRIVER SET 30W RJ45 WAGO WINSTA

Seuraavan tuotteen kytkennät tehdään kytkentäkaavion **(1.2)** mukaisesti. EQ10127786 – DRIVER SET 30W RJ45

L ulkojohdin, 230 V~

N nollajohdin

 Maadoitusjohdin

3 Hävittäminen/takuu

 Tätä laitetta ei saa hävittää lajittelemattoman kaatopaikkajätteen seassa. Käytettyjen laitteiden omistajilla on lakisääteinen velvollisuus hävittää laite asianmukaisesti. Tietoja saat kaupunkisi tai kuntasi virastosta.

ESYLUXin valmistajan takuu on saatavana osoitteesta www.esylux.com.

Oikeus teknisiin ja optisiin muutoksiin pidätetään.

NO KORT VEILEDNING

FARE!

Livsfare på grunn av elektrisk støt!

- Installerling skal kun utføres av elektroinstallatører eller elektrofagpersoner i henhold til forskriftene i det aktuelle landet
- Før montering/demontering må nettspenning kobles ut

1 Tiltenkt bruk

LED-driversettet er laget for ESYLUX Satellite LED-lamper. Disse skal brukes i opphengte tak innendørs.

EQ10127755 – DRIVER SET TW 38W RJ45 WAGO WINSTA DALI DT8 Plug & Play LED-driversett DALI TW. For ESYLUX Satellite Tunable White LED-lamper.

- Primært koblet til driver: 1 m svart kabel med 5-polet svart/blå kontakt WAGO WINSTA 770
- Sekundært koblet til driver: 1 m blå kabel (kaldhvit kanal) og 1 m rød kabel (varmhvit kanal) med RJ45-plugg

EQ10127762 – DRIVER SET 30W RJ45 WAGO WINSTA DALI Plug & Play LED-driversett DALI.

For ESYLUX Satellite LED-lamper med konstant lysfarge.

- Primært koblet til driver: 150 mm hvit kabel til koblingsboks og 1 m svart kabel med 5-polet svart/blå kontakt WAGO WINSTA 770
- Sekundært koblet til driver: 1 m blå kabel til RJ45-plugg

EQ10127779 – DRIVER SET 30W RJ45 WAGO WINSTA

Plug & Play LED-driversett ON/OFF. For ESYLUX Satellite LED-lamper med konstant lysfarge.

- Primært koblet til driver: 150 mm hvit kabel til koblingsboks og 1 m svart kabel med 3-polet svart plugg WAGO WINSTA 770
- Sekundært koblet til driver: 1 m lang blå kabel til RJ45-plugg

EQ10127786 – DRIVER SET 30W RJ45 LED-driversett ON/OFF.

For ESYLUX Satellite LED-lamper med konstant lysfarge.

- Primært koblet til driver: 150 mm hvit kabel med 3-polet innstikksklemme, 2,5 mm³ i en koblingsboks med strekkavlastning
- Sekundært koblet til driver: 1 m lang blå kabel til RJ45-plugg

Monteringstype/-sted

Innbygging/tak

Leveranse

1 stk. LED-driversett

2 Tilkobling

Tilkobling for følgende artikkel utføres som illustrert i figur **(1.1)**. EQ10127755 – DRIVER SET TW 38W RJ45 WAGO WINSTA DALI DT8 EQ10127762 – DRIVER SET 30W RJ45 WAGO WINSTA DALI EQ10127779 – DRIVER SET 30W RJ45 WAGO WINSTA

Tilkobling for følgende artikkel utføres som illustrert i koblingsplanen **(1.2)**. EQ10127786 – DRIVER SET 30W RJ45

L Ytterledning 230 V~

N Nøytralleder

 Jordledning

3 Kasting/garanti

 Denne enheten skal ikke kastes med restavfall som ikke er kildesortert. Eiere av kasserte enheter er forpliktet etter loven til å kvitte seg med enheten i henhold til forskriftene. Ta kontakt med kommunen for nærmere informasjon.

ESYLUX' produsentgaranti finner du på www.esylux.com

Med forbehold om tekniske og utseendemessige endringer.

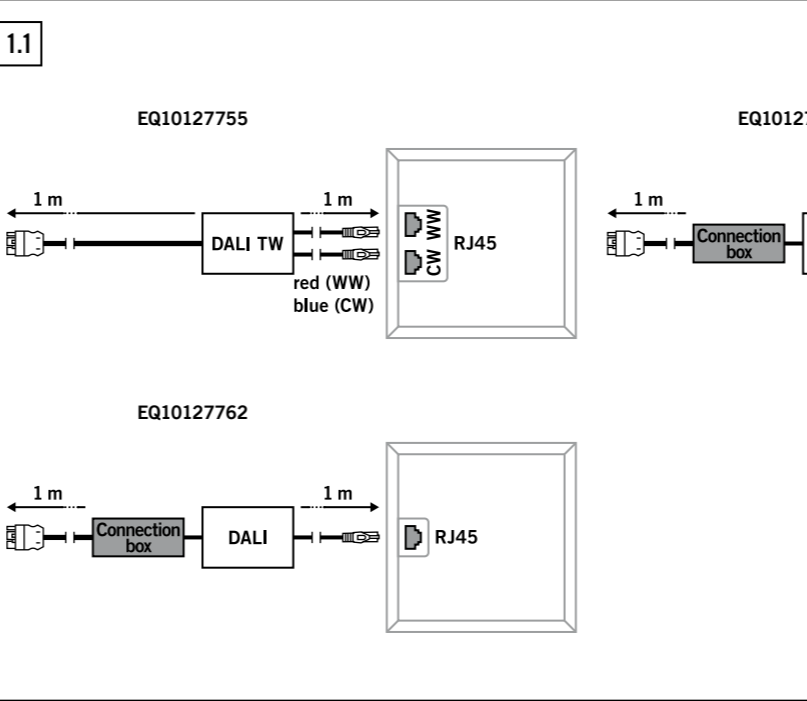

IT ISTRUZIONI IN BREVE

PERICOLO!

Pericolo di morte dovuto a scossa elettrica!

- L'installazione deve essere eseguita solo da elettricisti e personale specializzato nell'osservanza delle disposizioni vigenti localmente
- Togliere la tensione di rete prima del montaggio/dello smontaggio

1 Utilizzo conforme

Il set driver a LED è concepito per luci a LED ESYLUX Satellite. L'applicazione è progettata per controsoffitti in ambienti interni.

EQ10127755 – DRIVER SET TW 38W RJ45 WAGO WINSTA DALI DT8 Plug & Play Set driver a LED DALI TW.

Per luci a LED ESYLUX Satellite Tunable White.

- Collegato al driver sul lato primario: Cavo nero da 1 m con connettore a 5 poli nero/blu WAGO WINSTA 770
- Collegato al driver sul lato secondario: Cavo blu da 1 m (canale bianco freddo) e cavo rosso da 1 m (canale bianco caldo) con connettore RJ45

EQ10127762 – DRIVER SET 30W RJ45 WAGO WINSTA DALI Plug & Play Set driver a LED DALI.

Per luci a LED ESYLUX Satellite con colore della luce costante.

- Collegato al driver sul lato primario: Cavo bianco da 150 mm su una scatola di derivazione e cavo nero da 1 m con connettore a 5 poli nero/blu WAGO WINSTA 770
- Collegato al driver sul lato secondario: Cavo blu da 1 m con connettore RJ45

EQ10127779 – DRIVER SET 30W RJ45 WAGO WINSTA

Set driver a LED Plug & Play ON/OFF.

Per luci a LED ESYLUX Satellite con colore della luce costante.

- Collegato al driver sul lato primario: Cavo bianco da 150 mm su una scatola di derivazione e cavo nero da 1 m con connettore a 3 poli nero WAGO WINSTA 770
- Collegato al driver sul lato secondario: Cavo blu da 1 m con connettore RJ45-Stecker

EQ10127786 – DRIVER SET 30W RJ45

Set driver a LED ON/OFF.

Per luci a LED ESYLUX Satellite con colore della luce costante.

- Collegato al driver sul lato primario: Cavo bianco da 150 mm con morsetto a innesto a 3 poli, 2,5 mm³ in una scatola di derivazione con fermacavo
- Collegato al driver sul lato secondario: Cavo blu da 1 m con connettore RJ45-Stecker

Dati tecnici

	EQ10127755 DRIVER SET TW 38W RJ45 WAGO WINSTA DALI DT8	EQ10127762 DRIVER SET 30W RJ45 WAGO WINSTA DALI	EQ10127779 DRIVER SET 30W RJ45 WAGO WINSTA	EQ10127786 DRIVER SET 30W RJ45
Collegamento	WAGO, RJ45	WAGO, RJ45	WAGO, RJ45	0,5 - 2,5 mm², RJ45
Peso	460 g	440 g	340 g	240 g
Umidità relativa	max. 80 %, non condensante	10 - 90 %, non condensante	10 - 90 %, non condensante	10 - 90 %, non condensante
Colore	nero	nero / bianco	nero / bianco	nero / bianco
Tensione nominale	220-240 V ~ / 50-60 Hz	200-240 V ~ / 50-60 Hz	200-240 V ~ / 50-60 Hz	200-240 V ~ / 50-60 Hz
Consumo in standby	< 0,25 W	< 0,5 W	< 0,5 W	< 0,5 W
Consumo	35 W	34 W	30 W	30 W

Tipo e luogo di montaggio

Montaggio/soffitto

Fornitura

1 x set driver a LED

2 Collegamento

Il collegamento per i seguenti articoli avviene come da figure **(1.1)**.

EQ10127755 – DRIVER SET TW 38W RJ45 WAGO WINSTA DALI DT8 EQ10127762 – DRIVER SET 30W RJ45 WAGO WINSTA DALI EQ10127779 – DRIVER SET 30W RJ45 WAGO WINSTA

Il collegamento per il seguente articolo avviene come da schema dei collegamenti **(1.2)**.

EQ10127786 – DRIVER SET 30W RJ45

L Conduttore esterno 230 V~

N Conduttore di neutro

 Conduttore di protezione

3 Smaltimento/garanzia

 Il presente dispositivo non deve essere smaltito come rifiuto urbano indifferenziato. Chi possiede un vecchio dispositivo è vincolato per legge allo smaltimento conformemente alle normative in vigore. Per ulteriori informazioni rivolgersi all'amministrazione comunale.

La garanzia del produttore ESYLUX è disponibile sul sito Internet www.esylux.com.

L'azienda si riserva il diritto di apportare modifiche tecniche ed estetiche.

Item no.	Product name	X mm	Y mm	Z mm		
EQ10127755	DRIVER SET TW 38W RJ45 WAGO WINSTA DALI DT8	215	70	31		
EQ10127762	DRIVER SET 30W RJ45 WAGO WINSTA DALI	103	68	30		
EQ10127779	DRIVER SET 30W RJ45 WAGO WINSTA	132	45	30		
EQ10127786	DRIVER SET 30W RJ45	132	45	30		

ES GUÍA RÁPIDA

⚠ ¡PELIGRO!

⚡ Peligro de muerte por descarga eléctrica.

- La instalación debe realizarse solo por instaladores eléctricos o electricistas especializados de conformidad con las normativas específicas del país
- Antes del montaje/desmontaje, desconecte la tensión de alimentación

1 Utilización reglamentaria

El conjunto de controladores LED se ha diseñado para las luminarias LED Satellite de ESYLUX. Está indicado para su utilización en falsos techos en interiores.

EQ10127755 – DRIVER SET TW 38W RJ45 WAGO WINSTA DALI DT8

- Conjunto de controladores LED plug & play DALI TW. Para las luminarias LED Satellite Tunable White de ESYLUX.
- Conectado en el lado primario del controlador: un cable negro de 1 m con conector negro/azul WAGO WINSTA 770 de 5 polos
 - Conectados en el lado secundario del controlador: un cable azul de 1 m (canal blanco frío) y un cable rojo de 1 m (canal blanco cálido) con conector RJ45

EQ10127762 – DRIVER SET 30W RJ45 WAGO WINSTA DALI

Conjunto de controladores LED plug & play DALI. Para las luminarias LED Satellite de ESYLUX con color de luz constante.

- Conectados en el lado primario del controlador: un cable blanco de 150 mm conectado a una caja de conexiones y, conectado a su vez a esta, un cable negro de 1 m con conector negro/azul WAGO WINSTA 770 de 5 polos
- Conectados en el lado secundario del controlador: un cable azul de 1 m con conector RJ45

EQ10127779 – DRIVER SET 30W RJ45 WAGO WINSTA

Conjunto de controladores LED plug & play ACT./DESACT. Para las luminarias LED Satellite de ESYLUX con color de luz constante.

- Conectados en el lado primario del controlador: un cable blanco de 150 mm conectado a una caja de conexiones y, conectado a su vez a esta, un cable negro de 1 m con conector negro/azul WAGO WINSTA 770 de 3 polos
- Conectado en el lado secundario del controlador: un cable azul de 1 m con conector RJ45

Características técnicas

	EQ10127755 DRIVER SET TW 38W RJ45 WAGO WINSTA DALI DT8	EQ10127762 DRIVER SET 30W RJ45 WAGO WINSTA DALI	EQ10127779 DRIVER SET 30W RJ45 WAGO WINSTA	EQ10127786 DRIVER SET 30W RJ45
Conexión	WAGO, RJ45	WAGO, RJ45	WAGO, RJ45	0,5 - 2,5 mm², RJ45
Peso	460 g	440 g	340 g	240 g
Humedad ambiental relativa	máx. 80 %, no condensada	10 - 90 %, no condensada	10 - 90 %, no condensada	10 - 90 %, no condensada
Color	negro	negro/blanco	negro/blanco	negro/blanco
Tensión nominal	220 - 240 V ~ / 50 - 60 Hz	200 - 240 V ~ / 50 - 60 Hz	200 - 240 V ~ / 50 - 60 Hz	200 - 240 V ~ / 50 - 60 Hz
Consumo en modo de reposo	< 0,25 W	< 0,5 W	< 0,5 W	< 0,5 W
Consumo de energía	35 W	34 W	30 W	30 W

EQ10127786 – DRIVER SET 30W RJ45

Conjunto de controladores LED ACT./DESACT.

Para las luminarias LED Satellite de ESYLUX con color de luz constante.

- Conectado en el lado primario del controlador: un cable blanco de 150 mm con borne enchufable de 3 polos, 2,5 mm³ en una caja de conexiones con descarga de tracción
- Conectado en el lado secundario del controlador: un cable azul de 1 m con conector RJ45

Tipo/lugar de montaje

Encastre/techo

Volumen de suministro

1 conjunto de controladores LED

2 Conexión

La conexión de los siguientes artículos se realiza conforme a la ilustracione (1.1).

EQ10127755 – DRIVER SET TW 38W RJ45 WAGO WINSTA DALI DT8
EQ10127762 – DRIVER SET 30W RJ45 WAGO WINSTA DALI
EQ10127779 – DRIVER SET 30W RJ45 WAGO WINSTA

La conexión de los siguientes artículos se realiza conforme al esquema de conexiones (1.2).

EQ10127786 – DRIVER SET 30W RJ45

L Cable exterior de 230 V~

N Conductor neutro

Conductor protector

3 Eliminación/garantía

Este equipo no debe desecharse en la basura convencional. Los propietarios de equipos usados están obligados por ley a desecharlos en contenedores especiales. Solicite información a su administración municipal o regional.

Puede encontrar la garantía de fabricante ESYLUX en Internet en www.esylux.com.

Reservado el derecho a realizar cambios técnicos y estéticos.

PT GUIA DE INÍCIO RÁPIDO

⚠ PERIGO!

⚡ Perigo de morte devido a choque eléctrico!

- A instalação deve ser efectuada apenas por técnicos de instalações eléctricas ou electricistas especializados, em conformidade com os regulamentos específicos do país
- Antes da montagem/desmontagem, cortar a tensão de rede

1 Utilização correcta

O conjunto de controladores LED foi concebido para as luminárias LED Satellite da ESYLUX. O conjunto destina-se à utilização em tectos falsos em espaços interiores.

EQ10127755 – DRIVER SET TW 38W RJ45 WAGO WINSTA DALI DT8
Conjunto de controladores LED DALI TW Plug & Play. Para luminárias LED Satellite Tunable White da ESYLUX.

- Ligado ao controlador no lado primário: cabo preto de 1 m com conector WAGO WINSTA 770 preto/azul de 5 pólos
- Ligado ao controlador no lado secundário: cabo azul de 1 m (canal branco frio) e cabo vermelho de 1 m (canal branco quente) com conector RJ45

EQ10127762 – DRIVER SET 30W RJ45 WAGO WINSTA DALI

Conjunto de controladores LED DALI Plug & Play. Para luminárias LED Satellite da ESYLUX com cor da luz constante.

- Ligado ao controlador no lado primário: cabo branco com 150 mm numa caixa de ligação e cabo preto de 1 m com conector WAGO WINSTA 770 preto/azul de 5 pólos
- Ligado ao controlador no lado secundário: cabo azul de 1 m com conector RJ45

EQ10127779 – DRIVER SET 30W RJ45 WAGO WINSTA

Conjunto de controladores LED ON/OFF Plug & Play. Para luminárias LED Satellite da ESYLUX com cor da luz constante.

- Ligado ao controlador no lado primário: cabo branco com 150 mm numa caixa de ligação e cabo preto de 1 m com conector WAGO WINSTA 770 preto de 3 pólos
- Ligado ao controlador no lado secundário: cabo azul de 1 m com conector RJ45

EQ10127786 – DRIVER SET 30W RJ45

Conjunto de controladores LED ON/OFF.

Para luminárias LED Satellite da ESYLUX com cor da luz constante.

- Ligado ao controlador no lado primário: cabo branco de 150 mm com terminal de encaixe de 3 pólos, 2,5 mm³ numa caixa de ligação com descarga de tração
- Ligado ao controlador no lado secundário: cabo azul de 1 m com conector RJ45

Dados técnicos

	EQ10127755 DRIVER SET TW 38W RJ45 WAGO WINSTA DALI DT8	EQ10127762 DRIVER SET 30W RJ45 WAGO WINSTA DALI	EQ10127779 DRIVER SET 30W RJ45 WAGO WINSTA	EQ10127786 DRIVER SET 30W RJ45
Ligação	WAGO, RJ45	WAGO, RJ45	WAGO, RJ45	0,5 - 2,5 mm², RJ45
Peso	460 g	440 g	340 g	240 g
Humidade relativa do ar	máx. 80 %, sem condensação	10 - 90 %, sem condensação	10 - 90 %, sem condensação	10 - 90 %, sem condensação
Cor	preto	preto/branco	preto/branco	preto/branco
Tensão nominal	220 - 240 V ~ / 50 - 60 Hz	200 - 240 V ~ / 50 - 60 Hz	200 - 240 V ~ / 50 - 60 Hz	200 - 240 V ~ / 50 - 60 Hz
Consumo em modo de espera	< 0,25 W	< 0,5 W	< 0,5 W	< 0,5 W
Consumo de potência	35 W	34 W	30 W	30 W

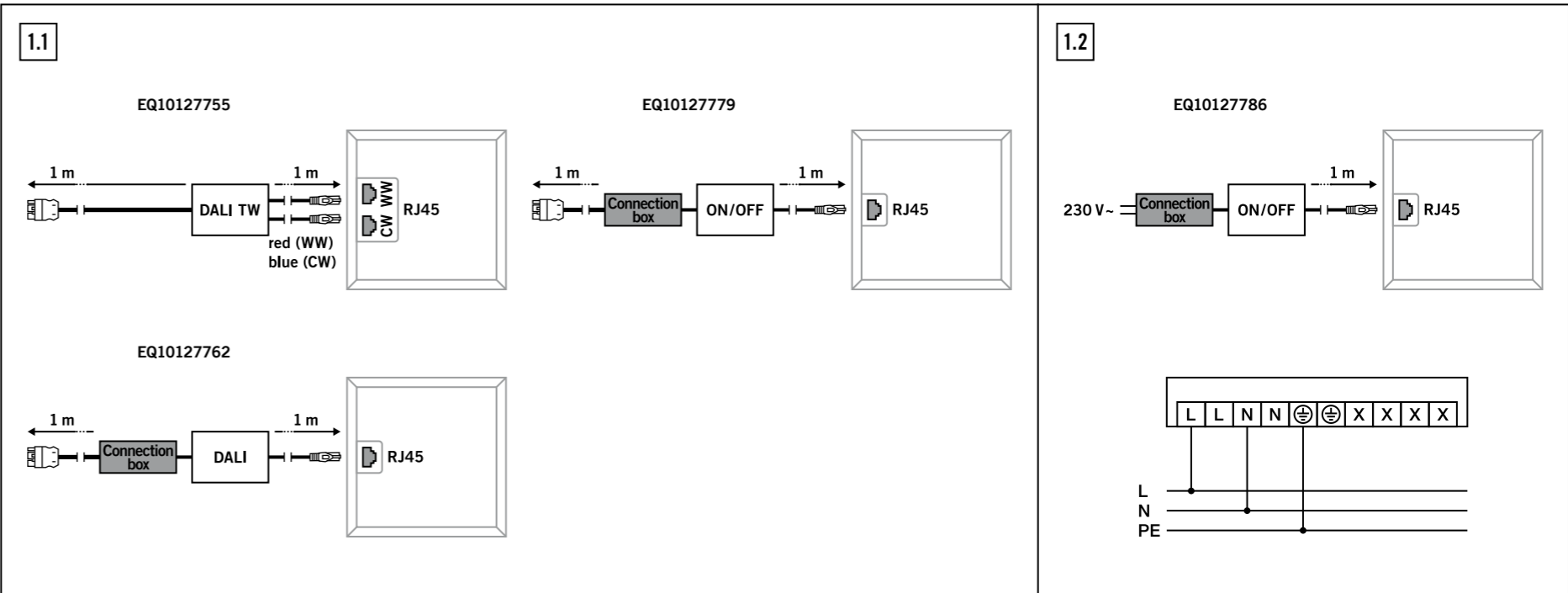

RU КРАТКОЕ РУКОВОДСТВО

⚠ ОПАСНО!

⚡ Опасность для жизни в результате поражения электрическим током!

- Установка должна проводиться только электромонтерами или другими специалистами-электриками с соблюдением местных предписаний
- Перед монтажом/демонтажем необходимо отключить напряжение сети

1 Использование по назначению

Комплект блока питания предназначен для использования с дополнительными светодиодными светильниками ESYLUX. Устанавливается в подвесных потолках в помещениях.

EQ10127755 – DRIVER SET TW 38W RJ45 WAGO WINSTA DALI DT8

Комплект блока питания DALI TW, подключаемого по технологии Plug & Play.

- Для дополнительных светодиодных светильников ESYLUX с цветовой температурой Tunable White.
- Со стороны источника питания к блоку питания подключены: черный кабель длиной 1 м с 5-контактным черно-синим штекером WAGO WINSTA 770
 - Со стороны потребителя к блоку питания подключены: синий кабель длиной 1 м (канал холодного белого света) и красный кабель длиной 1 м (канал теплого белого света) со штекером RJ45

EQ10127762 – DRIVER SET 30W RJ45 WAGO WINSTA DALI

Комплект блока питания DALI, подключаемого по технологии Plug & Play.

Для дополнительных светодиодных светильников ESYLUX с фиксированной цветовой температурой.

- Со стороны источника питания к блоку питания подключены: белый кабель длиной 150 мм подключен к клеммной коробке, к ней подключен черный кабель длиной 1 м с 5-контактным черно-синим штекером WAGO WINSTA 770
- Со стороны потребителя к блоку питания подключены: синий кабель длиной 1 м со штекером RJ45

EQ10127779 – DRIVER SET 30W RJ45 WAGO WINSTA

Комплект блока питания ON/OFF, подключаемого по технологии Plug & Play.

Для дополнительных светодиодных светильников ESYLUX с фиксированной цветовой температурой.

- Со стороны источника питания к блоку питания подключены: белый кабель длиной 150 мм подключен к клеммной коробке, к ней подключен черный кабель длиной 1 м с 3-контактным черным штекером WAGO WINSTA 770

Технические характеристики

	EQ10127755 DRIVER SET TW 38W RJ45 WINSTA DALI DT8	EQ10127762 DRIVER SET 30W RJ45 WAGO WINSTA DALI	EQ10127779 DRIVER SET 30W RJ45 WAGO WINSTA	EQ10127786 DRIVER SET 30W RJ45
Подключение	WAGO, RJ45	WAGO, RJ45	WAGO, RJ45	0,5 - 2,5 mm², RJ45
Масса	460 г	440 г	340 г	240 г
Относительная влажность воздуха	макс. 80 %, без конденсации	10 - 90 %, без конденсации	10 - 90 %, без конденсации	10 - 90 %, без конденсации
Цвет	черный	черный/белый	черный/белый	черный/белый
Номинальное напряжение	220 - 240 В ~ / 50 - 60 Гц	220 - 240 В ~ / 50 - 60 Гц	220 - 240 В ~ / 50 - 60 Гц	220 - 240 В ~ / 50 - 60 Гц
Потребление в режиме ожидания	< 0,25 Вт	< 0,5 Вт	< 0,5 Вт	< 0,5 Вт
Потребляемая мощность	35 Вт	34 Вт	30 Вт	30 Вт

- Со стороны потребителя к блоку питания подключены: синий кабель длиной 1 м со штекером RJ45

EQ10127786 – DRIVER SET 30W RJ45

Комплект блока питания ON/OFF.

Для дополнительных светодиодных светильников ESYLUX с фиксированной цветовой температурой.

- Со стороны источника питания к блоку питания подключены: белый кабель длиной 150 мм с 3-контактной зажимной клеммой 2,5 мм³ в клеммной коробке с зажимом для разгрузки от натяжения
- Со стороны потребителя к блоку питания подключены: синий кабель длиной 1 м со штекером RJ45

Тип/место монтажа

Встроенный/потолок

Объем поставки

1 комплект блока питания

2 Подключение

Подключение следующих изделий осуществляется в соответствии с рисунками (1.1).

EQ10127755 – DRIVER SET TW 38W RJ45 WAGO WINSTA DALI DT8
EQ10127762 – DRIVER SET 30W RJ45 WAGO WINSTA DALI
EQ10127779 – DRIVER SET 30W RJ45 WAGO WINSTA

Подключение следующих изделий осуществляется в соответствии со схемой подключения (1.2).

EQ10127786 – DRIVER SET 30W RJ45

L Фазовый провод 230 В~

N Нейтральный провод

Защитный провод

3 Утилизация / гарантия

Данное устройство запрещено утилизировать вместе с несортированным мусором. Согласно закону владельцы отслуживших свой срок устройств обязаны утилизировать их надлежащим образом. Дополнительные сведения можно получить в местном городском или муниципальном управлении.

Гарантию производителя ESYLUX вы найдете в интернете на сайте www.esylux.com.

Мы оставляем за собой право на внесение изменений в технические и оптические параметры.

Дата производства см. 7-значный номер на продукте. Цифры 1 - 7 = ггггммвв (г = год, м = неделя, в = версия)