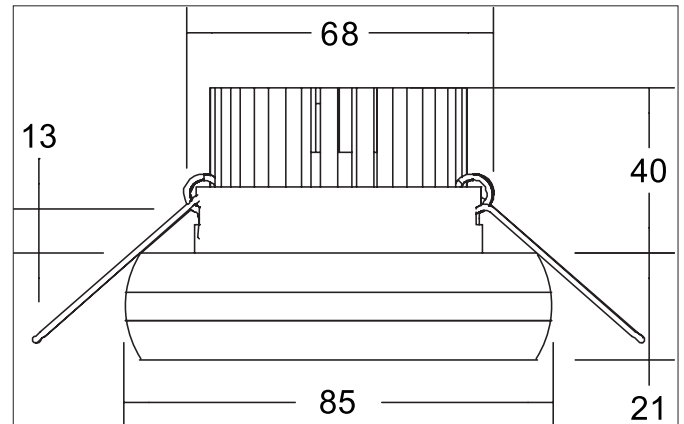

NATUNA LED recessed downlight with decorative sidelight, rounded outer edge

Article no. 12358173

Light.
For Generations.**Tender**

LED recessed downlight with decorative sidelight, rounded outer edge, Round. Toolless ceiling installation by installation springs. Ceiling cut-out Ø 68 mm, Installation depth 40 mm, Outer diameter 85 mm, Weight 0,166 kg, with rotationssymmetrical, deep, wide distributed light intensity. optimal light distribution due to a glass partially frosted cover. with Lamp holder Plug&Play max: 6 W, Delivery without bulb. Housing material: Aluminium / Glass / Plastic, Colour: White structure, Permissible ambient temperature (ta): -20 °C - +25 °C, Protection class (EN 61140): III, Degree of protection (DIN EN 60529): IP20, .For connection to an external driver, which is not included in the scope of delivery of the luminaire. Depending on driver dimmable.

Product Benefits

- Einbaudownlight in runder Bauform aus massivem Aluminium.
- Überraschendes, frisches Design mit Direkt- und Indirektanteilen.
- Deckenausschnitt 68 mm, Außendurchmesser 85 mm, Einbautiefe 40 mm, Lichtstrom 490 lm, IP20.
- Bei Verwendung eines geeigneten Konverters dimmbar.

NATUNA LED recessed downlight with decorative sidelight, rounded outer edge

Article no. 12358173

Light.
For Generations.

Article data	
Article no.	12358173
GTIN	4255752501008
Series name	NATUNA
Short description	LED recessed downlight with decorative sidelight, rounded outer edge
Material	Aluminium / Glass / Plastic
Colour	White
Type of surface	Structure
Shape	Round
Outer diameter	85 mm
Built-in diameter	68 mm
Installation depth	40 mm
Hight	21 mm
Weight	0.166 kg

Lighting technology	
Colour temperature	3.000 K
Light colour	White
Light output	Direct/Indirect
Luminous flux	490 lm
System efficiency	82 lm/W
Colour rendering	CRI > 80
Reflector	High-gloss
Beam angle	24°
Light sharing	Symmetric
Adjustable color temperature	No

Operating technology of the luminaire	
System output	6 W
Voltage type	DC
Current	350 mA
Lamp	LED
Lamp holder	Plug&Play
Protection class	III
Degree of protection	IP20
Dimmable	Depending on type of control gear
Control	Depending on driver
Bulb change possible	The light source of this luminaire may only be replaced by the manufacturer or a service technician commissioned by him or a similarly qualified person.
Rated life time L70/B50 at 25 °C	50,000 h

Mounting technology	
Mounting method	Recessed mounting
Place of installation	Ceiling-mounted
Adjustability	Not adjustable
Max. ceiling thickness	13 mm
stamp	UKCA
Further references	No cover with thermal insulation material
Material cover	Glass partially frosted
Circlip	Without circlip

NATUNA LED recessed downlight with decorative sidelight, rounded outer edge

Article no. 12358173

Light.
For Generations.

Packing data	
Gross weight	0.23 kg
Length of packaging	130 mm
Packaging width	100 mm
Packaging height	80 mm
Disposal at end of life	<p>This product must not be disposed of with household waste. You are obliged, to dispose of such electrical waste separately.</p> <p>By disposing of electrical waste and other old or defective electronics separately, you support recycling or other forms of re-use. In that way you help to take care and to avoid that harmful substances get into the environment.</p>

Required accessories	
----------------------	--