

LED power supply 24 V DC, dimmable
Article no. 17231000

Light.
For Generations.

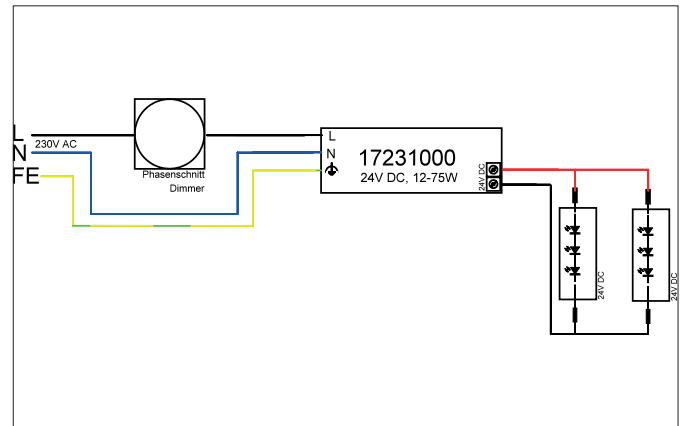

Tender

LED power supply 24 V DC, dimmable. Ceiling cut-out Installation depth mm, Length 185 mm, Width 60 mm, Weight 0,488 kg,, with max: 75 W, Delivery without bulb. Housing material: Plastic, Permissible ambient temperature (ta): -20 °C - +25 °C, Protection class (EN 61140): II, Degree of protection (DIN EN 60529): IP20. For direct connection to mains voltage, Trailing-edge phase dimmable.

Article data	
Article no.	17231000
GTIN	4251433938453
Short description	LED power supply 24 V DC, dimmable
Material	Plastic
Length	185 mm
Width	60 mm
Height	31 mm
Weight	0.488 kg

LED power supply 24 V DC, dimmable
Article no. 17231000

Light.
For Generations.

Operating technology of driver	
AC nominal voltage max	230 V
Frequenz max.	50 Hz
Protection class	II
Degree of protection	IP20
Starting current	30 A (300 µs)
Power min	12 W
Power	75 W
Control	Trailing-edge phase, Leading edge phase
Environment temperature (ta)	-10 °C bis +45 °C
Measure point (tc)	max. +85 °C

Packing data	
Gross weight	0.505 kg
Length of packaging	190 mm
Packaging width	35 mm
Packaging height	65 mm
Disposal at end of life	This product must not be disposed of with household waste. You are obliged, to dispose of such electrical waste separately. By disposing of electrical waste and other old or defective electronics separately, you support recycling or other forms of re-use. In that way you help to take care and to avoid that harmful substances get into the environment.