

Artikel-Nr.	663v
Bezeichnung	CEE-Anbaugerätestecker gerade 70x70mm 16A 3p 24VAC 50/60Hz IP44 TWIST
Langbeschreibung	CEE-Anbaugerätestecker gerade 70x70mm 16A 3p 24VAC 50/60Hz IP44 TWIST Gehäusematerial: PA6 Nennstrom: 16A Polzahl: 3 (3P) Nennspannung/Frequenz: 24V~ / 50+60Hz Kontakte: Messing vernickelt Anschlussstechnik: Schraubklemmen Abmessungen (Flansch/Bohrung): 70x70 mm / 56x56 mm Schutzart: IP44
GTIN (EAN)	9003399017544
Ursprungsland	AT
Zolltarifnummer	85366990
Nettogewicht	0,086 kg
Verpackungsmenge	10
Mindestbestellmenge	10

ETIM 9.0	EC001319
IEC-Stromstärke	16 A
Spannung nach EN 60309-2	20-25 V (50+60 Hz) violett
Polzahl	3
Schutzart (IP)	IP44
Anschlussstechnik	Schraubklemme
Bauform	Anbaugerätestecker
Steckrichtung	gerade
Werkstoff	Kunststoff

a	70 mm
b	70 mm
c	56 mm
d	56 mm
e	19 mm
f	28 mm
g	5 mm
h	43 mm
Leitung flexibel	4-10 mm ²
Leitung starr	4-10 mm ²
Kontaktschrauben	110 Ncm
Abmantelungslänge	70 mm
Abisolierlänge	14-16 mm
Umgebungstemperatur	-25 – 40 °C
Temperaturbeständigkeit	-25 – 80 °C

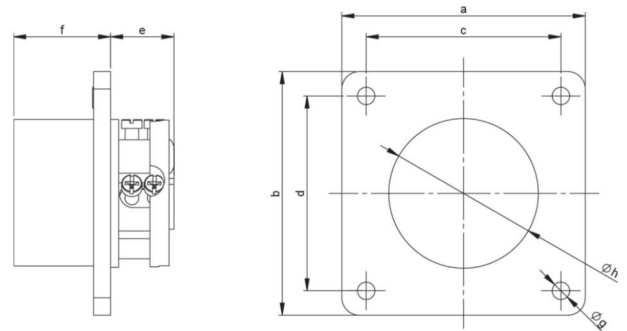

<https://www.pcelectric.at/shop/de/?func=detail&artnr=663v>