

5

4

3

2

1

D

C

B

A

Hood lower part

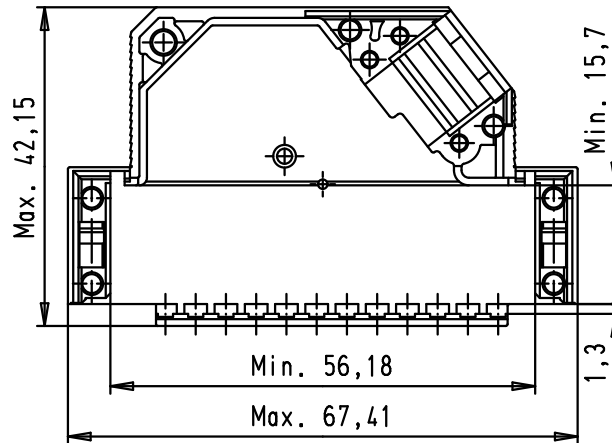
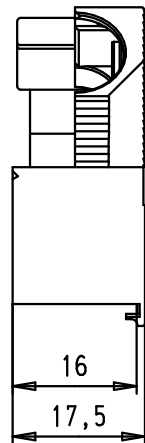
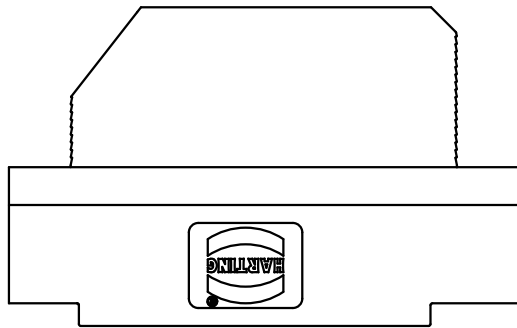

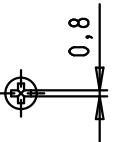
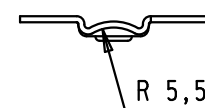
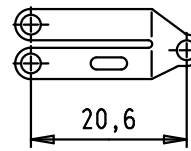
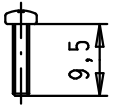
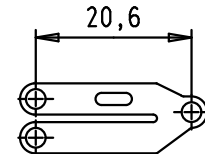
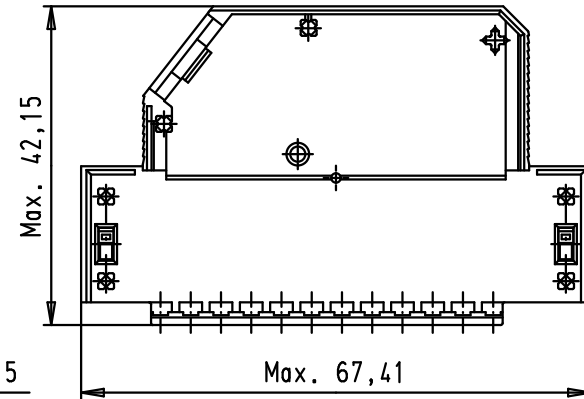
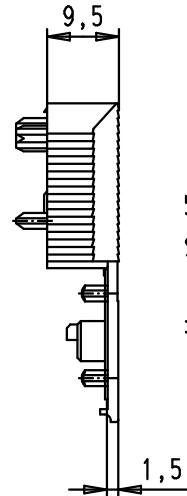

Hood upper part



Strain relief 1

Strain relief 2

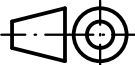
Flathead screws

				Dot.	Name	 All Dim. in mm Orig. Size DIN A 4	D-Sub hoods 50 poles not shielded	Maßstab/ Scale 1:1
			Detail.	27/02/03	SH			
			Insp.					
			Stand.					
EC01696	20/04/10	SC	HARTING EURL F-95972 Paris				TB 09 67 050 0571	Blatt/ Page 1 / 1
34793	10/01/08	PK						
31392	27/02/03	SH						
Mod.	Dot.	Name						