

DEHNguard DG MU 3PH ... 4W+G (R)

Technical Data

**DANGER**  
**Hazardous Voltage**  
 Will cause severe injury or death.  
 Working on or near energized circuits poses a serious risk of electrical shock. De-energize all circuits before installing or servicing this equipment and follow all prescribed safety procedures.



Figure without obligation

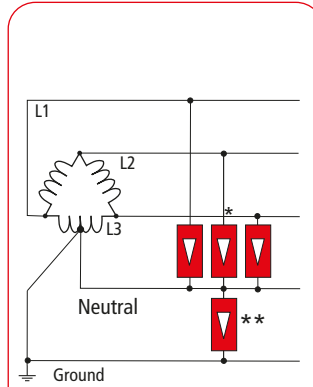

XXX/XXX High Leg Delta

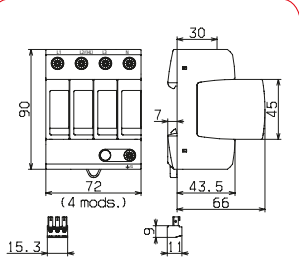

Dimension drawing

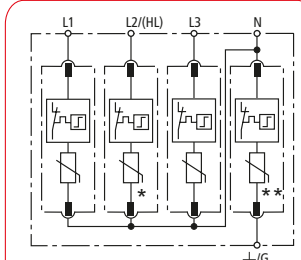

Basic circuit diagram

System Information			
Nominal Voltage (Vac)		120/240	240/480
MCOV [L-N]/[L-G]		230 V / 410 V	385 V / 565 V
[N-G]/[L-L]		180 V / 460 V	180 V / 770 V
[H-N]/[H-G]		275 V / 455 V	510 V / 690 V
[L-H]		505 V	895 V
Phase		3 Phase High Leg	3 Phase High Leg
Number of Poles		4	4
Number of Wires		5	5
Types	W/O Remote (Part No.)	DG MU 3PH 240 4W+G 908 343	DG MU 3PH 480 4W+G 908 344
	With Remote (Part No.)	DG MU 3PH 240 4W+G R 908 348	DG MU 3PH 480 4W+G R 908 349
Nominal Discharge Current (In)		20 kA	20 kA
Max. Discharge Current (Imax)		50 kA	50 kA
SCCR (rms symmetrical amperes)		200 kA	200 kA
Frequency		50/60 Hz	50/60 Hz
Voltage Protection Rating	[L-N/L-G]	0.7 kV / 1.2 kV	1.2 kV / 1.8 kV
	[N-G/L-L]	0.6 kV / 1.5 kV	0.6 kV / 2.5 kV
	[H-N/H-G]	0.8 kV / 1.5 kV	1.5 kV / 2.0 kV
	[L-H]	1.5 kV	2.5 kV
Replacement Plug	Type (Part No.)	DG PLU 230 (908 012) DG PLU 275 (904 010)* DG PLU 180 (908 011)**	DG PLU 385 (908 014) DG PLU 510 (908 013)* DG PLU 180 (908 011)**
IP Rating		IP 20	
Maximum Ambient Temperature		+85° C	
Dimensions	W/O (W) remote	H: 3.54 in (90 mm), W: 2.83 in (72 mm), D: 2.6 in (66 mm)	
Weight		15.6 oz (15.7 oz) 0.443 kg (0.445 kg)	
Enclosure material		Thermoplastic, red, UL 94 V-0	
Mounting method		35 mm DIN rail acc. to EN 60715	
Application		UL Type 1 Open Type SPD, CSA Type 4-1 Component Assembly	
Approval standard		ANSI UL 1449 / CSA C22.2 No.269.1, CSA C22.2 No. 269.4	

Cu Conductors	1/2" 12 mm	1/2" 12 mm	1/2" 12 mm
min. □ L, N, G, ⊥	2.5 mm <sup>2</sup> / 14 AWG		
max. □ L, N, G, ⊥	25 mm <sup>2</sup> / 4 AWG		
Busbar	16 mm <sup>2</sup> Cu  ≥15.5 mm		

**Mounting** Phillips Head driver  
 Torque to 4 Nm/35-45 Lbs-in

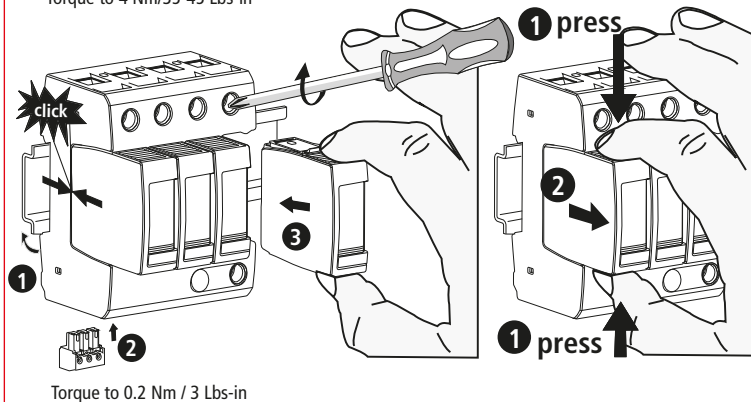

Torque to 0.2 Nm / 3 Lbs-in

Mounting

Visual Indication Status

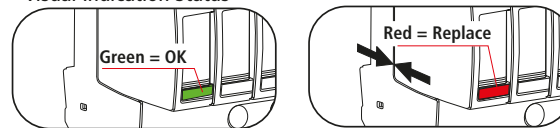

Fault Indication & Remote Contact Signaling (with modules installed)

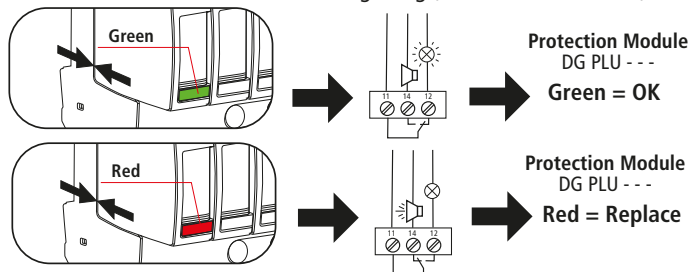

Testing Remote Contact Signaling (with modules installed)

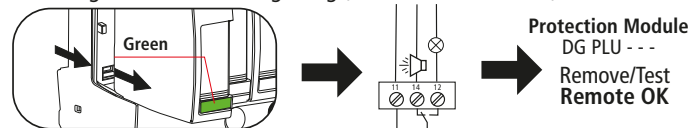

Fault Indication

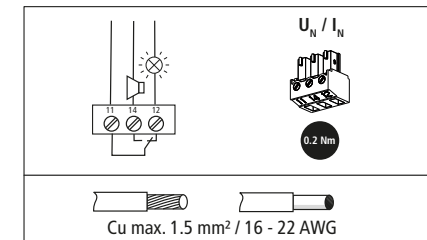

The remote status indicator (SPDT contact) shall be connected to NEC class 2 circuits only!

Remote Contact Signaling

- = Audio Alarm/Alert
- = PLC / Monitoring System Connection

p.t.o.



Figure without obligation

DG MU 3PH ... 4W+G (R)

UL 1449 Type 1  
SPD CSA C22.2 Type 4-1  
Component Assembly

## DEHNgard MU 3PH \_\_ \_\_ 4W+G (R) Modular Multipole Surge Arrester

### 1. Application of the DEHNgard MU series

The modular DEHNgard MU... Surge Protective Device (SPD), with its Red/Line family design sets new standards in terms of safety and user-friendliness. These surge arresters are designed to protect against transient overvoltages generated by distant lightning strikes or localized switching surges. Typical installations would be near the main service entry, distribution boards, sub-distribution boards, breaker panels or control cabinets associated with specific electrical equipment such as PLCs, drives or other sensitive equipment. The UL approved protective circuit with heavy-duty zinc oxide varistors in combination with the dual "Thermo Dynamic Control" monitoring device characterizes the DEHNgard technology. Main features of the device show that both, safety and reliability of the SPDs are key elements of the modular DEHNgard MU. The locking arrester module, which is keyed to prevent incorrect replacement, allows for easy and safe replacement while being robust in its lifetime without release from its socket due to vibration, mechanical shock or electromotive forces. Nevertheless, they can be easily replaced without tools by simply pressing the user-friendly module release button of the arrester modules. Like with all DEHN surge arresters with "Thermo Dynamic Control" evaluation is based on the intensity of the discharge current and the surface temperature of the heavy-duty varistor. In order to avoid incorrect insertion by the installer or user when replacing the modules each protective circuit of the multipole surge arresters and each protection module are mechanically coded. The dual Thermo Dynamic Control monitoring stands for experience of decades in the international use of surge protective devices and considers many fields of application where SPDs might be damaged. Like with all DEHN surge arresters with Thermo Dynamic Control evaluation is based on the intensity of the discharge current and the surface temperature of the heavy-duty varistor.

The green or red visual indicator shows if each arrester module is ready for operation. In addition to this visual status indication, included in the DEHNgard MU...R devices is a set of isolated Form C (SPDT) contacts for remote signaling. With its isolated Form C contact, the remote signal can be used as a make or break contact according to the particular circuit concept. The surge arresters of the multipole modular DEHNgard MU family feature multifunctional terminals on a standardized spacing of 1 module for the connection of conductors and busbars, allowing easy wiring with other DIN rail mounted devices.

### 2. Safety Instructions

**Warning:** Risk of Electric Shock - Disconnect power before servicing. Service to be performed by qualified personnel only.

**Attention:** Risque de choc.

Suitable for use on a circuit capable of delivering not more than 200 kA rms symmetrical amperes.

Convient à des circuits produisant au plus 200 kA eff.

The SPD is intended for installation within a NEMA Type 1 enclosure in accordance with the National Electrical Code, ANSI/NFPA 70.

Surge Protection  
Lightning Protection  
Safety Equipment  
DEHN protects.

DEHN SE

Hans-Dehn-Str. 1  
Postfach 1640  
92306 Neumarkt  
Germany

Tel. +49 9181 906-0  
www.dehn-international.com



- ➔ The DEHNgard MU series SPD is to be installed only by qualified personnel and to be done so in compliance with all local and National Electrical Code requirements.
- ➔ For proper system protection and safety, coordination with other SPDs within the facility must be considered. Contact our application engineer for assistance if in doubt.
- ➔ Installation and connection to service must be done only when the system is de-energized.
- ➔ The arrester's installation is to be compliant with its rating and therefore must not be installed in a more severe environment subjecting it to higher voltages, currents or energy levels than for which its technical specifications provide.
- ➔ These devices must be provided with a suitable end-product enclosure having adequate strength and thickness and with acceptable spacings being provided.
- ➔ The arrester is designed for indoor applications and must be placed in a suitable rated NEMA enclosure if the system is to be in a harsher environment.
- ➔ Opening or tampering with the thermoplastic enclosure may damage the effective operation of the SPD and is inadvisable and will void the warranty.

### 3. General Installation Instructions

Sections 250 and 285 of the NEC (NFPA 70) and the IEEE Green Book-Std. 142 should be consulted. Local electrical codes and/or the Canadian Electrical code also have to be considered.

**System voltage:** Make sure that the SPD is correctly rated for the system where the SPD should be applied. **The maximum continuous operating voltage (MCOV) must not be exceeded.**

**Mounting:** Make sure that the SPD is installed as close as possible to the device to be protected. The conductor length for these connections must be kept as short and as straight as possible. The SPDs are to be mounted on the 35 mm DIN rail. The rail is to be securely mounted to the back of the interior of the panel or flat surface using ¼ inch bolts every 8 inches (200 mm). The SPDs can either be slid on the rail from open end or put on the rail by compressing the spring loaded clamping device on the lower back of each unit. The SPDs shall permit sufficient clearance for conductor power and signaling connections.

**Conductor Connections:** Phase connections to the SPD and ground side connections from the SPD to the ground bus must be of the wire size indicated in the technical specifications before. Insulation should be stripped back as described on the previous page. All conductor terminal screws shall be tightened to the torque indicated in the technical data. If the SPDs are installed more than six conductor feet (two meters) from the neutral to ground bond point (usually service entrance) than an additional SPD should be installed between neutral and ground (at the service entrance).

**Grounding:** Make sure that the grounding of the SPD is as short and straight as possible with the specified wire size according to the technical data. Use a local equipotential bonding bar if possible. For proper operation the SPD must be connected to a low impedance ground. Recommend using the largest diameter (high strand count) wire possible without exceeding the technical data for maximum wire size.

**Remote Contact Signaling:** In case of a device with remote contact signaling make sure that the torque is as indicated in the technical data.

**Non Fusing:** The DEHNgard MU is designed to be installed without fuses. It is suitable for use on a circuit with maximal SCCR and Nominal Voltage according to Technical Data. This device features an internal protection that will disconnect the surge protective component at the end of its useful life but will maintain power to load - now unprotected. If this situation is undesirable for the application, the arrester plug-in module must be replaced.

**Problem Diagnostics:** If there should be any problem please contact your local DEHN representative.