



# IndustryLUX FLAT 2.0

60 | 85 x 135° | 4.000K



## LICHTVERTEILUNGSKURVE

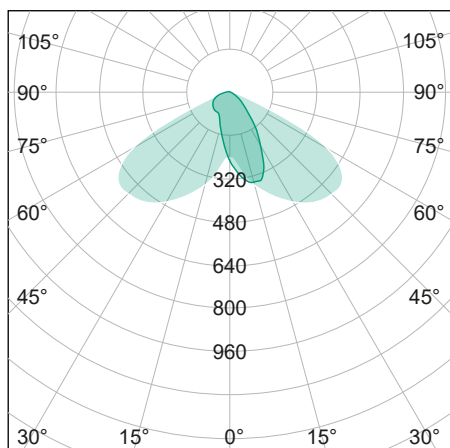

## TECHNISCHE ZEICHNUNG

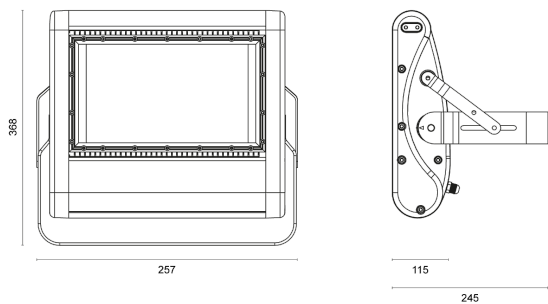

## LICHTTECHNIK

Abstrahlwinkel	85 x 135°
Farbtemperatur	4.000 K
Farbtoleranz	< 5 SDCM
Farbwiedergabeindex	> 80

## EIGENSCHAFTEN

Durchgangsverdrahtung	nein
Anschluss	Leitung: 3 x 1,0 mm <sup>2</sup> , 2,0 m
Modul per LSS* B10A	5
Modul per LSS* B16A	8
Modul per LSS* C10A	9
Modul per LSS* C16A	14
Schaltzyklen	> 500.000
Spannungsbereich AC	100 – 240 V AC, 50/60 Hz
Spannungsbereich DC	176 – 250 V DC

## BESTELLÜBERSICHT

IndustryLUX FLAT 2.0 60   85 x 135°   4.000K	
Artikelnummer	442285060091
EAN-Code	4260374016830

## ZUBEHÖR

Für dieses Produkt ist derzeit kein Zubehör erhältlich

## LEISTUNG

Lichtausbeute	141 lm/W
Systemleistung	64 W
Leuchtenlichtstrom	9.000 lm
Dimmbar	nein

## BELASTBARKEIT

Schutzklasse	I
Schlagfestigkeit	IK08
Schutzart	IP65
Garantie	5 Jahre
Lebensdauer	> 60.000 h [L80, B10]
UV-beständig	Ja
Betriebstemperatur	-40 bis +50 °C
Einsatz im Lebensmittelbereich	nein

## MATERIAL

Abdeckung	klar
Material (Abdeckung)	Glas
Material (Gehäuse)	Aluminium
Gehäusefarbe	schwarz

## LIEFERUMFANG

standardmäßig ohne weiteren Lieferumfang

## ABMESSUNG

L x B x H / Ø (H2)	260 x 325 (370) x 115 (245) mm
Gewicht	4,2 kg