

**EN DuoFern Motion Detector (interior) 9484**  
Instruction manual for the electrical connection and for commissioning

Item no. 3250 17 72

Type: 9484



With your purchase of a **DuoFern Motion Detector 9484**, you have chosen a quality product manufactured by RADEMACHER. Thank you for the trust you have placed in us.

RADEMACHER products have been developed with the greatest possible convenience in mind. Having applied uncompromising quality standards and thorough testing, we are proud to be able to present this innovative product to you.

It's brought to you by all the highly-qualified personnel here at RADEMACHER.



<b>i</b>	<b>Dear Customer</b> .....	<b>2</b>
<b>1.</b>	<b>These instructions</b> .....	<b>5</b>
1.1	Application of this manual.....	5
<b>2.</b>	<b>Hazard symbols</b> .....	<b>6</b>
2.1	Levels of danger and signal words.....	6
2.2	Symbols and depictions used.....	7
<b>3.</b>	<b>Safety Instructions</b> .....	<b>8</b>
3.1	Intended Use.....	8
3.2	Incorrect Use .....	9
3.3	Required Expert Knowledge of the Installer .....	10
3.4	Glossary - Definition.....	11
<b>4.</b>	<b>Included in delivery</b> .....	<b>12</b>
<b>5.</b>	<b>General View of the Operating Unit</b> .....	<b>13</b>
5.1	General View of the Installation Housing .....	14
5.2	Electrical connections.....	15
5.3	Indicator Lights .....	16
5.4	Functions and Button Combinations .....	17
<b>6.</b>	<b>Product Description</b> .....	<b>19</b>
6.1	Compatible switches.....	20
6.2	Overview of Features .....	21
6.3	Functions and Examples of Application.....	22
6.4	The Function of the Overload Protection.....	26
<b>7.</b>	<b>Technical Specifications</b> .....	<b>27</b>
7.1	Detection Ranges and Degrees.....	31
7.2	Detection Levels and Range.....	32
7.3	Factory Settings .....	33
<b>8.</b>	<b>Selecting the suitable Installation Location</b> .....	<b>34</b>

<b>9.</b>	<b>Connecting the DuoFern Motion Detector 9484 .....</b>	<b>37</b>
9.1	Safety Instructions for the Electrical Connection .....	37
9.2	Important Information regarding the Electrical Installation .....	38
9.3	Carrying out the Electrical Connection .....	39
9.4	Connection Diagram with Lamp and Push Button .....	40
9.5	Connection Diagram with Changeover Switch.....	41
<b>10.</b>	<b>Installation after the Electrical Connection .....</b>	<b>42</b>
<b>11.</b>	<b>Important Information regarding the Commissioning .....</b>	<b>43</b>
<b>12.</b>	<b>Selecting the Operating Mode .....</b>	<b>44</b>
<b>13.</b>	<b>Manual Operation .....</b>	<b>45</b>
<b>14.</b>	<b>Setting the Sensitivity .....</b>	<b>46</b>
<b>15.</b>	<b>Setting the Brightness Set Limit.....</b>	<b>47</b>
<b>16.</b>	<b>Setting the Run-on Time .....</b>	<b>50</b>
<b>17.</b>	<b>Logging DuoFern Devices On / Off .....</b>	<b>52</b>
17.1	Logging on DuoFern Devices .....	53
17.2	Logging off DuoFern Devices .....	54
17.3	Logging-on to the HomePilot® .....	55
17.4	Clearing Process in the DuoFern Network .....	57
<b>18.</b>	<b>Hardware Reset in the event of Unit Failure .....</b>	<b>58</b>
<b>19.</b>	<b>Erase all Settings, Software Reset .....</b>	<b>59</b>
<b>20.</b>	<b>Dismounting .....</b>	<b>60</b>
<b>21.</b>	<b>Simplified EU Declaration of Conformity.....</b>	<b>61</b>
<b>22.</b>	<b>Warranty Conditions.....</b>	<b>62</b>

...describe how to install, connect and operate the DuoFern Motion Detector 9484.

### 1.1 Application of this manual

- ◆ Before you begin, please read this manual through completely and follow all the safety instructions.
- ◆ Please also read the instruction manuals of the accessories (if available) as well as the instructions of the respective connected appliance.
- ◆ This manual is a component of the product. Please store it in an easily accessible place.
- ◆ When passing the DuoFern Motion Detector 9484 on to a third party, this manual must be passed on as well.
- ◆ Damage resulting from non-compliance with these instructions and safety instructions will void the guarantee. We shall assume no liability for any consequential damage.



## 2. Hazard symbols

EN

The following hazard symbols are used in this instruction manual:



**Danger of fatal electric shock**



**Danger area / dangerous situation**



### 2.1 Levels of danger and signal words

 **DANGER!**

This hazard will lead to serious injury or death if not avoided.

 **WARNING!**





This hazard may result in serious injury or death if not avoided.

 **CAUTION!**

This hazard may result in minor or moderate injury if not avoided.

 **ATTENTION!**

This hazard may lead to property damage.

Depiction	Description
1.	Procedures
2.	
◆	Itemisation
1) or a)	Lists
	further useful information
	Please read the respective manual
	Indicator light flashes red
	Indicator light flashes green
●	Indicator light lights up red
●	Indicator light lights up green
○	Indicator light is off



**The use of defective equipment can lead to personal injury and damage to property (electric shocks / short circuiting).**

- ◆ Never use defective or damaged equipment.
- ◆ Check that the DuoFern Motion Detector 9484 is intact.
- ◆ Consult our customer service department in the event that you discover damage, see page 64.

### 3.1 Intended Use

Only use the DuoFern Motion Detector 9484 for connecting and controlling electrical appliances (e.g. lighting etc.) within the permissible load limits, see “Technical Specifications”.

#### **Operating conditions**

- ◆ Only use the DuoFern Motion Detector 9484 in dry rooms.
- ◆ A 230 V / 50 Hz power supply, together with a site-provided disconnecting device (fuse), must be available at the installation location.



- ◆ The installation and operation of the radio systems is only permitted for those systems and devices where a malfunction in the transmitter or receiver would not cause a danger to personnel or property or where this risk is already covered by other safety equipment.



Radio systems which transmit on the same frequency can cause interference.

Using the DuoFern Motion Detector 9484 for any other purpose than previously mentioned is not permissible.



**Improper use can lead to serious injuries or property damage.**

- ◆ The DuoFern Motion Detector 9484 is not suitable to be used for an electrically safe disconnection.
- ◆ Never use the radio system (e.g. DuoFern radio system) and its components for the remote control of appliances and systems with increased safety-relevant requirements or where there is an accident risk. Such applications require additional safety equipment. Observe the respective statutory regulations for the installation of such systems.



**There is a risk to life caused through short circuiting and electric shocks if the DuoFern Motion Detector 9484 is used outside or in damp rooms.**

- ◆ Do not install and use the DuoFern Motion Detector 9484 outdoors or in damp rooms.

## 3.3 Required Expert Knowledge of the Installer

The electrical connection, installation and commissioning of the DuoFern Motion Detector 9484 must only be carried out by a qualified electrician in accordance with the instructions in this manual.

**DuoFern**

- ◆ RADEMACHER radio technology for controlling compatible products.

**HomePilot®**

- ◆ The HomePilot® is a central controller unit for RADEMACHER radio products.

**ELV**

- ◆ Extra-low Voltage.

**SELV**

- ◆ Safety Extra-low Voltage

**PIR-Sensor**

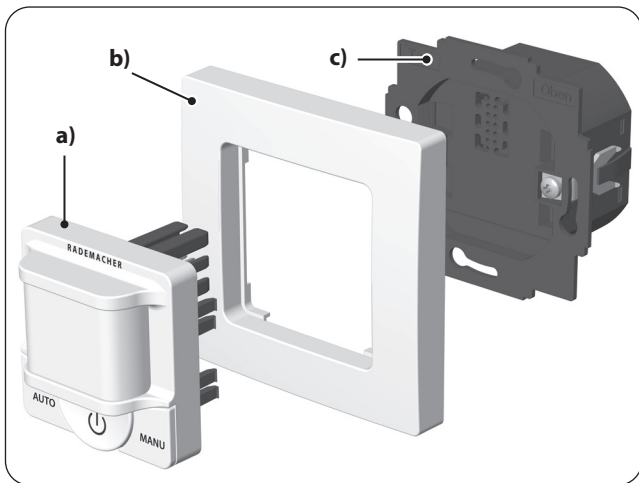

- ◆ Passive Infra-red Sensor

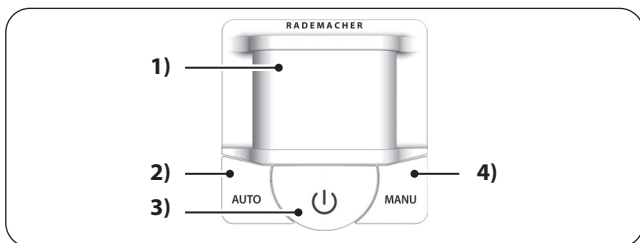

### **Included in delivery**

- a)** 1 x Operating unit (50 x 50 mm)
- b)** 1 x Frame
- c)** 1 x Installation housing
- d)** 1 x Instruction manual (not illustrated)



Pos.	Symbol	Description
1)		<b>Sensor panel with motion sensor, indicator lights and lens.</b>
2)		<b>Automatic button [A]</b> <ul style="list-style-type: none"> <li>◆ Enable automatic mode (activate motion sensor).</li> <li>◆ Test and set the sensitivity level. *</li> </ul>
	<b>Press for 4 seconds</b> >	
3)		<b>On / Off button</b> <ul style="list-style-type: none"> <li>◆ Switch the connected appliance on / off; see page 45.</li> <li>◆ Test and set the brightness value. *</li> </ul>
	<b>Press for 4 seconds</b> >	
4)		<b>Manual button [M]</b> <ul style="list-style-type: none"> <li>◆ Enable manual mode (deactivate motion sensor).</li> <li>◆ Test and set the run-on time. *</li> </ul>
	<b>Press for 4 seconds</b> >	

\* The values are respectively set in combination with the other setting buttons, see table on page 17.

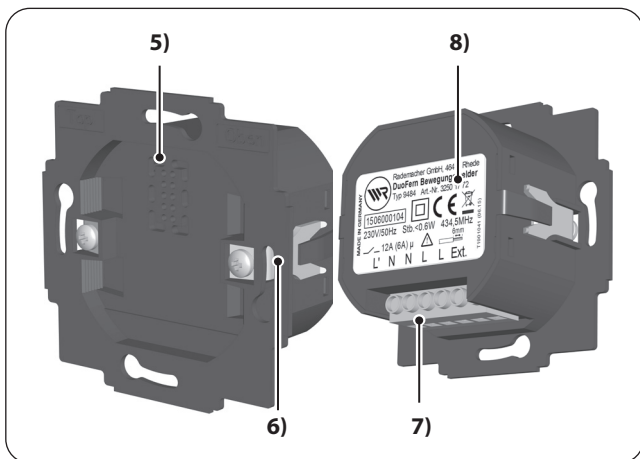

Pos.	Symbol	Description
5)		Plug-in coupling for the operating unit
6)		Claw fasteners and screws
7)		Connecting terminals
8)		Type plate

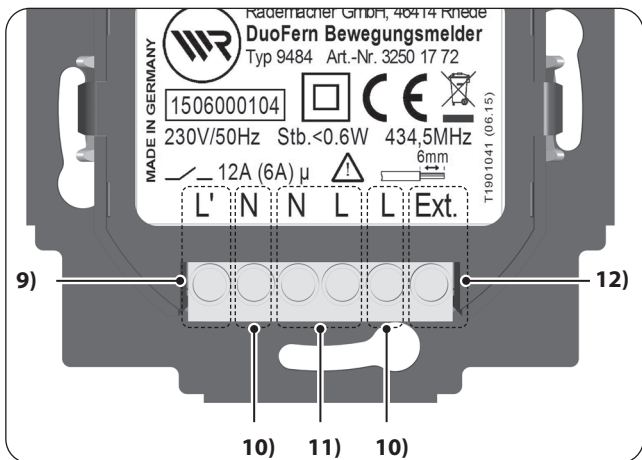



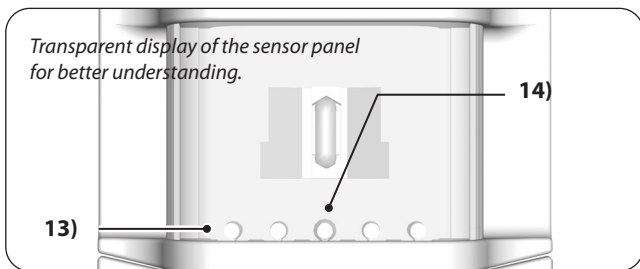































Pos.	Symbol	Description
9)		<b>Control output [ L' ] 230 V / 50 Hz ~</b> Connection of the electric appliance.
10)		<b>Additional connecting terminals [ L / N ]</b> Additional internal wiring of the electric appliance and/or of the external input.
11)		<b>Voltage supply [ L / N ] 230 V / 50 Hz ~</b> Connection of the supply voltage.
12)		<b>Control input [ Ext. ]</b> Connection of an external switch / push-button for manual control on site.



Pos.	Symbol	Description
<b>13)</b>	● ● ● ● ●	<b>Indicator lights 1 to 5 - red</b> <i>Status display and setting parameters via individual or all LEDs.</i>
	red	<i>Running light</i> <i>Learning phase during commissioning.</i>
	permanently lit up	<i>Status display or display of the set value.</i>
	All of the 5 LEDs flash	<i>The overload protection was enabled, see page 26.</i>
<b>14)</b>	○ ○ ● ○ ○	<b>Indicator light 3 - red / green</b>
	green	<i>flashing</i> ◆ <i>The current brightness is being measured.</i> ◆ <i>The DuoFern login mode is active.</i>
	red	<i>flashing</i> ◆ <i>Clearing process is active</i> ◆ <i>The DuoFern log off mode is active.</i>



Function	Button / Button Combination	
Activate or deactivate the appliance	 1 x tap  LED display when automatic mode is active  LED display when manual mode is active	45
Switch on automatic mode	 1 x tap 	44
Switch on manual mode	 1 x tap 	44
Settings		
Display the set sensitivity level	 4 sec.	46
Increase sensitivity	 4 sec. +  tap	46
Decrease sensitivity	 4 sec. +  tap	46
Display the set brightness set limit	 4 sec.	47
Increase brightness set limit	 4 sec. +  tap	48
Decrease brightness set limit	 4 sec. +  tap	48

Function	Button / Button Combination	
Adopting the current brightness as the set limit	 8 sec.	48
Display the set run-on time	 4 sec.	51
Decrease the run-on time	 4 sec. +  tap	51
Increase the run-on time	 4 sec. +  tap	51
Logging on DuoFern devices	 +  1 sec.	53
Logging off DuoFern devices	 +  1 sec.	54
Clearing process in the DuoFern network	 +  1 sec.	57
Software reset	 +  +  4 sec.	59

The DuoFern Motion Detector 9484 serves to control electric appliances and to trigger scenes.

### **The operating principle**

---

As soon as the built-in sensor detects motion within its detection range, the connected appliance (e.g. light, ventilation / heating or air conditioning systems, etc.) is switched on and then switched off again after an adjustable run-on time.

An integrated brightness sensor controls the lighting conditions and determines when the motion detector is enabled. For this, a brightness set limit can be set.

### **Use in the DuoFern network**

---

The DuoFern Motion Detector 9484 can be integrated into a DuoFern network to use the range of functions of other DuoFern devices such as the HomePilot®.

### **External control input [Ext.] for manual operation on site**

---

For manual operation, one or multiple external switches or push buttons can be connected to the control input [Ext.] of the DuoFern Motion Detector 9484.

### **Installation and electrical connection**

---

The DuoFern Motion Detector 9484 is designed as a flush-mounted device for indoor rooms. The electrical connection is carried out by means of the connecting terminals on the reverse side of the installation housing.

With the provided frame, the DuoFern Motion Detector 9484 can be integrated into customary switches. Suitable switches can be found in the table below.

<b>Manufacturer</b>	<b>Switch</b>
<b>BERKER</b>	Arsys / K1 / S1
<b>BUSCH-JAEGER</b>	Busch-Duro 2000 Si / Reflex Si / alpha exclusive / alpha nea / solo / impuls
<b>GIRA</b>	Standard-System / S-Color-System / Stainless steel / Standard 55
<b>JUNG</b>	CD 500 / ST 550 / LS 990 / CDplus and CD, however, with coloured rings
<b>MERTEN</b>	M1 / Atelier / Artec / Tracent / Antique New
<b>PEHA</b>	Standard / Dialog / Aura
<b>LEGRAND</b>	Creo / Tenara
<b>VEDDER</b>	Alessa (plus)



If the supplied frame is replaced by frames of other switches, it may, under circumstances, lead to a reduced degree of detection of 170°.

- ◆ Integrated DuoFern radio system
- ◆ Stand-alone-mode:
  - One time use (switching on/off an electrical appliance)
  - Additional control of DuoFern actuators possible
  - Login and control via the HomePilot® possible
- ◆ Combined mode:
  - Easy combination of multiple motion detectors via the DuoFern radio system
  - Additional control of DuoFern actuators possible
  - Login and control via the HomePilot® possible
- ◆ Remote control via the DuoFern HomePilot®, central operating unit, manual transmitter and wall controller, etc.
- ◆ Control input for an external switch/push button enabling manual operation on site
- ◆ Setting options:
  - Sensitivity of the motion sensor
  - Run-on time
  - Brightness set limit
  - Adoption of the current brightness as a new brightness set limit
- ◆ Permanent storage of the settings
- ◆ Overload protection

### Application outline - stand-alone-mode

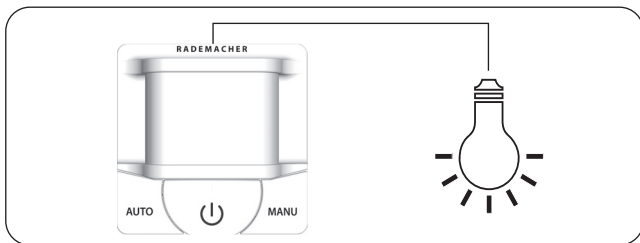

#### Stand-alone-mode

In stand-alone-mode, an electrical appliance (e.g. a lamp) can be directly connected to the DuoFern Motion Detector 9484 (see page 40) and via this it can be switched on and off.

#### Stand-alone-mode with DuoFern actuators

In addition, multiple DuoFern actuators can be logged on to and controlled via the motion detector, see page 52, logging on and off DuoFern devices.

### Application outline - Stand-alone-mode with multiple DuoFern Universal Actuators: Corridor lighting

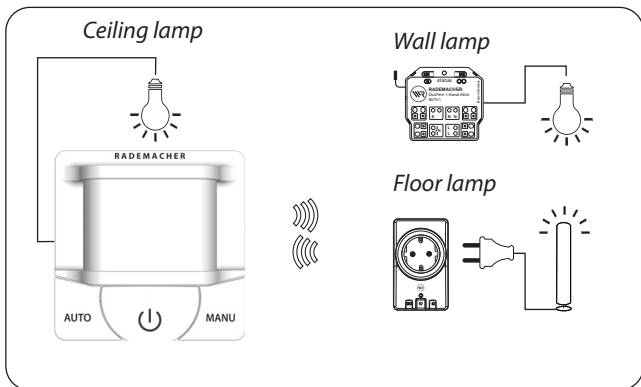

#### Example application:

### DuoFern Motion Detector 9484 with multiple DuoFern Universal Actuators: Corridor lighting

Multiple DuoFern Universal Actuators, to which the corridor lighting is connected, are logged on to the motion detector.

As soon as the motion detector detects motion, the connected appliance, and simultaneously all connected actuators, will be switched on. The switch-off is effected automatically after the run-on time.

All logged on actuators are switched on and off, even with manual operation on the device.

### Application outline - Stairway lighting in combined mode

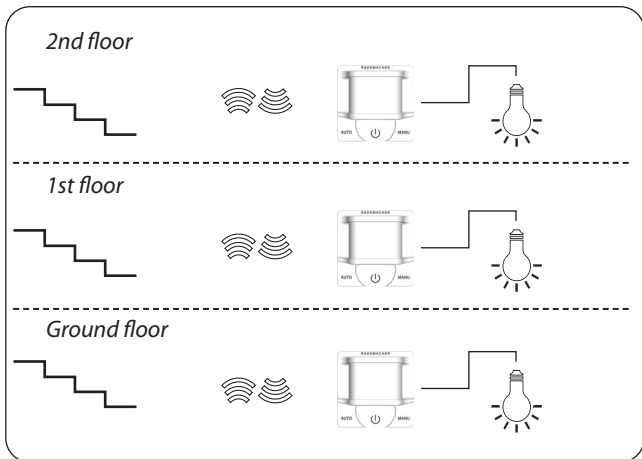

#### Combined mode

In the combined mode, multiple DuoFern Motion Detectors 9484 can be connected to each other via DuoFern.

In addition, DuoFern actuators can also be logged on to and controlled via individual motion detectors, see page 52, logging on and off DuoFern devices.



### Information regarding logging on and run-on time in the combined mode



All DuoFern Motion Detectors 9484 must be respectively connected to each other.



The run-on time must have the identical setting in all motion detectors.

- ◆ If the run-on time is altered on one motion detector, this new time will be automatically transferred to all motion detectors.

#### Example application:

##### Stairway lighting in combined mode

---

Installation of multiple DuoFern Motion Detectors 9484 in one stairway to control the stairway lighting.

The entire stairway lighting is switched on as soon as any of the motion detectors detect motion.

As soon as the run-on time of the motion detector that last detected the motion has expired, the entire stairway lighting is switched off again.

The DuoFern Motion Detector 9484 features an overload protection. Should the motion detector overheat due to overload, the motion detector will switch off.

### Display for overload



All of the indicator lights flash red.

### Behaviour when the overload protection is triggered

If the overload protection has been triggered, the connected appliance can no longer be switched on.

### Resetting the Overload Protection

- ◆ to reset the protection function, the DuoFern Motion Detector 9484 must be briefly disconnected from the network
- ◆ or the operating unit must be pulled out of the installation housing.

### What can I do if the overload protection is regularly triggered?



Please check that the connected appliance is not exceeding the load limits, see page 27, "Technical Specifications".

- ◆ Check that the cable cross-sections of the connecting cables suffice.

**Mains supply [L/N]**

Mains supply voltage:	230 V / 50 Hz ~
Consumption:	Standby: < 0.6 W

**Connection [L' and L / N]**

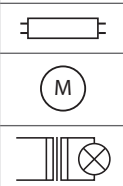
Switching voltage:	230 V / 50 Hz ~	
Maximum switching capacity:	ohmic load, e.g. bulbs	
		12 A (μ) (Type 1B)
	inductive loads such as: fluorescent lamps, drives, iron core transformers, e.g. for extra-low voltage bulbs such as halogen bulbs	
		6 A (μ) (Type 1B)

**Connection [L' and L / N]**

Maximum switching capacity:

capacitive loads such as: electronic transformers, AC/DC transformer, e.g. for extra-low voltage lamps such as halogen lamps, LEDs, etc.



6 A ( $\mu$ ) (Type 1B)

**Control input [Ext.]**

for an external, manual switch / push button on site

Input voltage:

230 V

Maximum length of the control cable:

10 m



**Improper use can lead to serious injuries or property damage.**

- ◆ Due to the small contact distance  $\mu$ , the
- ◆ DuoFern Motion Detector 9484 is not suitable to be used for an electrically safe disconnection.











**DuoFern radio technology**

Transmission frequency:	434.5 MHz
Transmission power:	max. 10 mW
Range:	indoors: approx. 30 m * outdoors: approx. 100 m <i>* depending on the building structure</i>
Max. number of DuoFern devices:	20

**General information**

Sensor type:	PIR (Passive Infra-red Sensor)
Permissible ambient temperature range:	0 °C to + 40 °C
Protection class:	II (only for use in dry areas)
Dimensions (W x H x D):	50 x 50 x 20 mm (operating unit)
Installation depth:	32 mm (installation housing)
Connecting terminals:	Screw terminals for max. 1.5 mm <sup>2</sup> cables cross-section

## Setting ranges

<p>Brightness set limit: *</p> <p>Five settings available, see page 47</p>	<p> = 5 lux</p> <p> = 10 lux</p> <p> = 50 lux</p> <p> = 200 lux</p> <p> = 700 lux **</p>
<p>Run-on time:</p> <p>Five settings available, see page 50</p>	<p> = 20 sec.</p> <p> = 1 min. **</p> <p> = 3 min.</p> <p> = 10 min.</p> <p> = 30 min.</p>
<p>Sensitivity:</p>	<p>min. to max.</p> <p>Five settings available, see page 46</p>

\* The current brightness can be adopted as a set limit.

\*\* Factory setting

## Setting ranges with the HomePilot®

<p>Run-on time: **</p>	<p>0.1 seconds to 55 minutes, continuously adjustable</p>
------------------------	---

\*\* In the HomePilot®, this setting can be found under the term "stairway function"

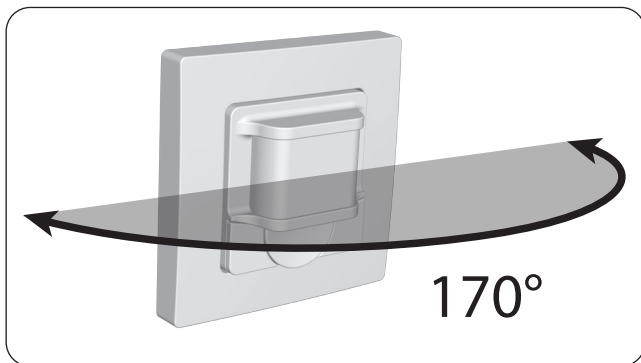

**Detection ranges**

Degree of detection:	approx. 170°
Detection range:	approx. 10 m
Detection levels:	2 horizontal levels (upper / lower)
Detection zones per level:	upper level = 26 zones
	lower level = 32 zones

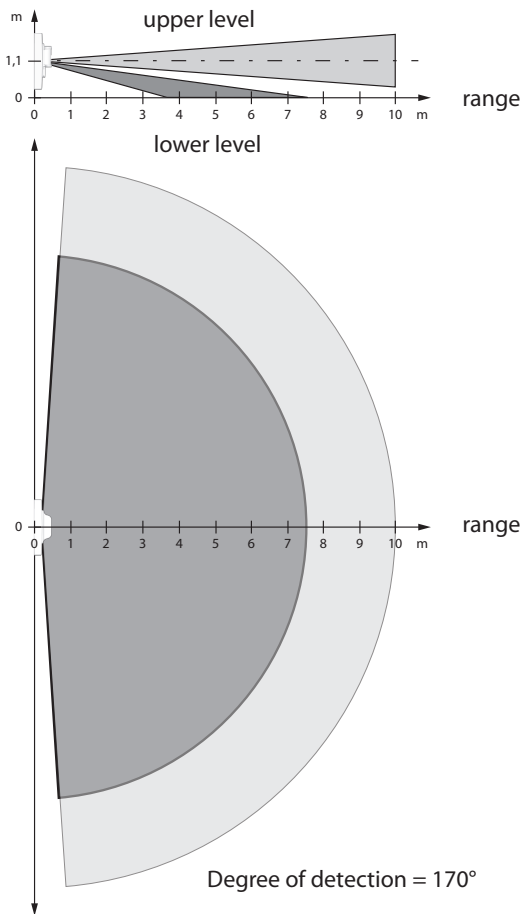
**Image of the degree of detection**





Factory Settings	
Automatic mode:	On
Brightness set limit:	700 lux = 
Run-on time:	1 minute = 
Sensitivity:	level 4 = 
DuoFern participants:	none

**Avoid installation near disturbing sources**

Disturbing sources that cause severe changes to the temperature in the motion detector's range of detection, may lead to errors being triggered.

◆ Do not install the DuoFern Motion Detector 9484 in the proximity of the following disturbing sources:

- Radiators, Heaters

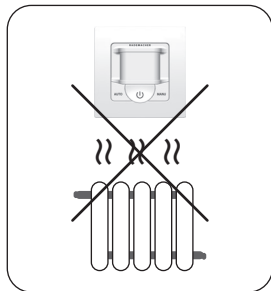

- Windows that are subject to high levels of solar radiation
- Ventilation and air conditioning systems

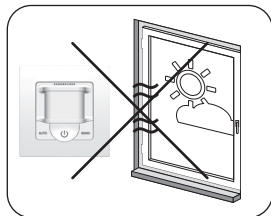

### Important information on the installation

- ◆ The DuoFern Motion Detector 9484 is intended for flush mounting. We recommend installation in a deep 58 mm flush-mounted box or in an electronic socket.
- ◆ In order to ensure optimal operation, the DuoFern Motion Detector 9484 should not be installed on a metallic base or near metal objects.
- ◆ Select an installation place that is as free from vibrations as possible

### The ideal installation height (see image)

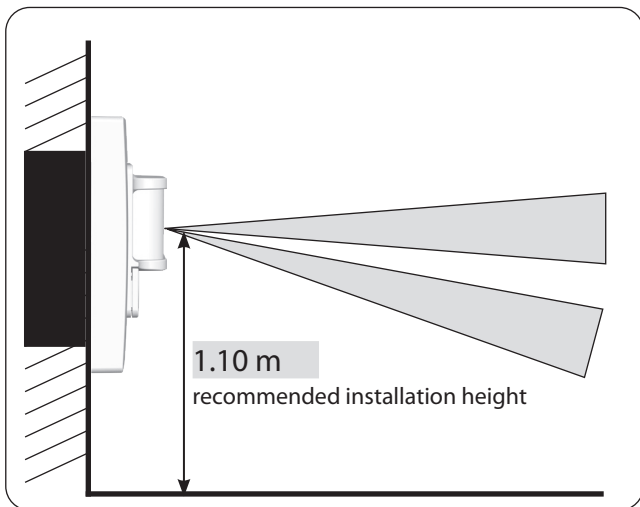

### Selecting an installation location with an optimum detection or range

The DuoFern Motion Detector 9484's optimum detection capacity is when moving at a right angle to it. Frontal movement to the DuoFern Motion Detector 9484 may reduce the sensitivity. Take these factors into consideration when selecting an installation location.

Installation location with an optimum detection range

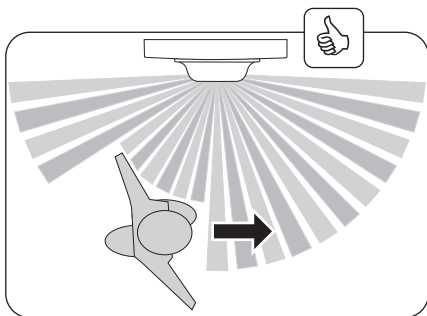

Installation location with a low detection range

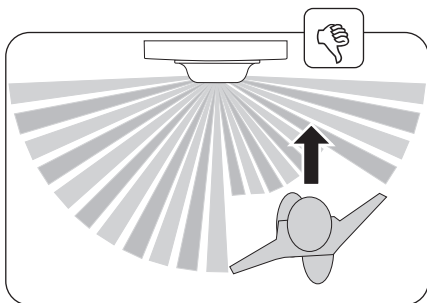

## **i** 9. Connecting the DuoFern Motion Detector 9484 **EN**

Prior to the electrical connection, check that the voltage / frequency on the type plate corresponds to that of the local mains supply.



Read the specifications relating to the electrical connection detailed in the instruction manual of the electrical appliance used.

### **i** 9.1 Safety Instructions for the Electrical Connection

#### **DANGER!**

**There is a risk of fatal electric shocks when touching electrical components.**

- ◆ All connection and installation work must only be carried out in a de-energised state.
- ◆ Disconnect all phases of the mains power supply cable and secure it to prevent any reconnection.
- ◆ Check that the system is de-energised.

#### **WARNING!**

**Short-circuiting, caused when the DuoFern Motion Detector 9484 is overloaded, poses a danger to life.**

- ◆ The maximum switching capacity must not be exceeded, for this, please observe the details in the “Technical Specifications”, see page 27.



**Using incorrect installation housing can lead to personal injury and damage to property (electric shocks / short circuiting).**

- ◆ Only use the provided installation housing to connect and mount the DuoFern Motion Detector 9484.
- ◆ Installation housings of other RADEMACHER products are not compatible.

## 9.2 Important Information regarding the Electrical Installation

### Connection instructions when using an external switch/ push button

- ◆ When using the control input [**Ext.**], you must connect the external switches / push buttons and the DuoFern Motion Detector 9484 to the same phase [**L**].
- ◆ The maximum length of lead to connect an external switch/ push button must not exceed 10 m.

### Length of insulation stripped:

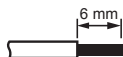

All leads must be stripped to 6 mm.

1. Ensure the mains are current-free and check whether the inlet leads are current-free.
2. Securely lay the connecting cables right into the flush-mounted box.
3. Remove the insulation on all leads down to 6 mm in length and connect them according to the following connection diagram.
4. After the electrical connection, the installation of the DuoFern Motion Detector 9484 into the flush-mounted box is carried out, see page 42.



## 9.4 Connection Diagram with Lamp and Push Button

EN

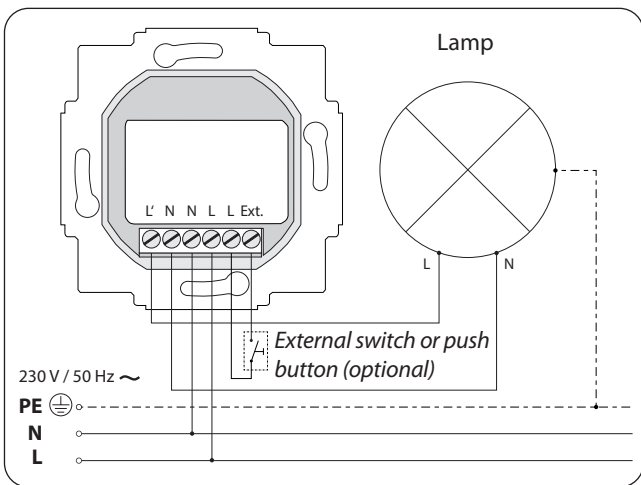

The additional connection terminals [N] and [L] are solely intended for wiring the connected electrical appliances and/or an external switch / push button.

- ◆ Do not use the connection terminals [N] and [L] for further indoor installations.



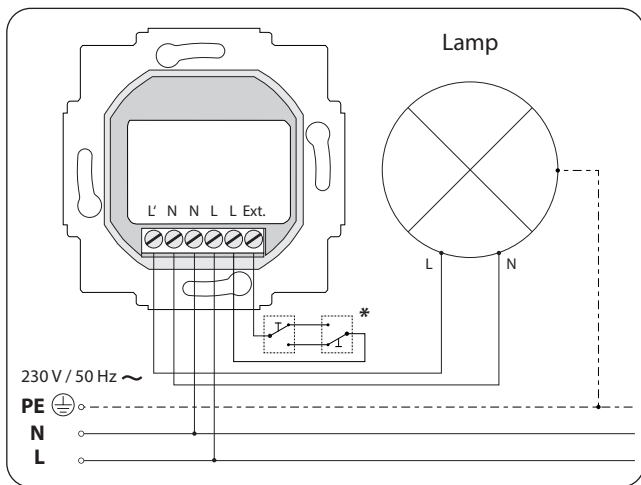

## 9.5 Connection Diagram with Changeover Switch

**EN**

\* *Changeover switch (cross connection also possible)*



The additional connection terminals [N] and [L] are solely intended for wiring the connected electrical consumers and/or an external switch / push button.

- ◆ Do not use the connection terminals [N] and [L] for further indoor installations.

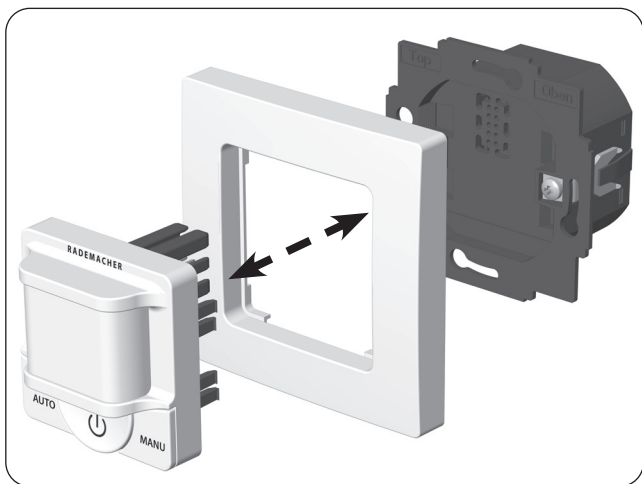

1. Insert the installation housing into the flush-mounted box and fasten it with the screws of the claw fasteners.
2. Place the frame onto the installation housing.
3. Subsequently, carefully insert the operating unit into the installation housing .
4. Switch on the mains power supply again.
5. The DuoFern Motion Detector 9484 starts with the learning phase, see next page.



## 11. Important Information regarding the Commissioning

Once the power supply is switched on, the learning phase of the DuoFern Motion Detector 9484 starts. This learning phase takes approx. 45 seconds; the running light on the indicator lights shows this.

### Running light during the learning phase of 45 seconds



After completion of the learning phase, the electrical appliance is briefly switched on/off and the motion detector is ready for use.

The DuoFern Motion Detector 9484 has two operating modes: "automatic mode" and "manual mode". If required, the desired operating mode can be enabled at any time.

### Display the activated operating mode:

1.  1 x  
The active operating mode is displayed every time the connected appliance is switched on / off, see page 45.

### Observe the indicator lights:



= The automatic mode is enabled if LEDs 1 and 3 light up red.



= The manual mode is enabled if LEDs 3 and 5 light up red.

### Switching on the automatic mode

1.  1 x  
The automatic mode is switched on by briefly tapping the AUTO button.

### Switching on the manual mode

1.  1 x  
The manual mode is switched on by briefly tapping the MANU button.





## 13. Manual Operation

EN

Manual operation of the DuoFern Motion Detector 9484 can be carried out with the on/off button or via a push button or switch connected to the control input [Ext.].

### Switching the appliance on/off

1.  or  1 x  
The connected appliance is switched on or off by briefly tapping the on/off button and/or by pressing the external push button or switch.
2. At the same time, the enabled operating mode is displayed by means of the indicator lights, see page 44.
3. In the automatic mode , the appliance is automatically switched off after the set run-on time, see page 51.



The appliance can also be switched off manually; this stops the run-on time.

- ◆ Subsequently, the DuoFern Motion Detector 9484 is locked for approx. five seconds to prevent unintentional restarting.

or

3. No run-on time is enabled in manual mode ; the appliance must be switched off manually.



The sensitivity of the DuoFern Motion Detector 9484 can be set to five different levels.

### Observe the following whilst setting the indicator lights:





 = minimum sensitivity

 = maximum sensitivity

### Display the set sensitivity level

1.  4 sec. Press and hold the button for approx. 4 seconds.
2.  The sensitivity level is displayed after approx. 4 seconds (example, factory setting).







### Increase / decrease the level of sensitivity

1.  Press and hold the AUTO button.
2. Tap on  +  After approx. 4 seconds, you can increase the sensitivity by additionally tapping on the MANU button.
3. Tap on  +  After approx. 4 seconds, you can decrease the sensitivity by additionally tapping on the on/off button.

With the brightness set limit, you can determine with which level of brightness the motion detector is enabled.



There are five different settings.

**Observe the following whilst setting the indicator lights:**





	= 5 lux (low level of brightness)
	= 10 lux
	= 50 lux
	= 200 lux
	= 700 lux (high level of brightness) *
	= Brightness sensor disabled

\* Factory setting

**Display the set brightness set limit**

-  4 sec. Press and hold the button for approx. 4 seconds.
-  The brightness set limit is displayed after approx. 4 seconds (example).

### Increase / decrease the brightness set limit



1.  4 sec. Press and hold the button.
2. Tap on  +  After approx. 4 seconds, you can increase the set limit by additionally tapping on the MANU button.
3. Tap on  +  After approx. 4 seconds, you can decrease the set limit by additionally tapping on the AUTO button.

### Adopting the current brightness as the set limit



If required, as an alternative to the setting, the current brightness can be adopted as the set limit.



Ensure that the sensor panel is not covered during the measurement.

1.  8 sec. Press and hold the button for 8 seconds.
2.  The set limit is displayed after approx. 4 seconds (example).



- 
3.  The indicator lights are switched off after approx. 8 seconds and the brightness measurement starts.
- 
4.  The measurement is completed as soon as the middle indicator light flashed green.
- 
5.  Subsequently the measured brightness is displayed as the new set limit.

With the run-on time, you can determine how long the connected appliance (e.g. lighting) remains switched on. There are five different settings.



With the HomePilot®, the run-on time can be infinitely adjusted between 0.1 seconds (pulsed operation) and approx. 55 minutes.

### Observe the following whilst setting the indicator lights:

	= 20 seconds
	= 1 minute (factory setting)
	= 3 minutes
	= 10 minutes
	= 30 minutes

\* After infinite adjustment in the HomePilot®, the indicator lights approximately display the set run-on time per level.

### Information on setting the run-on time in the HomePilot®

The run-on time is set in the HomePilot® under the description "**Stairway function**" in "milliseconds [ms] with a factor 100 ms".



#### Example:

1 second	=	10 *100 ms
1 minute	=	600 *100 ms
3 minutes	=	1800 *100 ms







From a run-on time of  $600 * 100$  ms on, it is possible to enable a switch-off advance warning (flashing prior to the actual switch off) by entering an uneven time (e.g.  $601 * 100$  ms).

### Display the set run-on time

1.  4 sec. Press and hold the button for approx. 4 seconds.
2.  The run-on time is displayed after approx. 4 seconds (example).

### Increase / decrease the run-on time

1.  4 sec. Press and hold the button.
2. Tap on  +  After approx. 4 seconds, you can increase the run-on time by additionally tapping on the on/off button.
3. Tap on  +  After approx. 4 seconds, you can decrease the run-on time by additionally tapping on the AUTO button.

To use the DuoFern Motion Detector 9484 with other DuoFern devices, each desired DuoFern device (e.g. DuoFern Universal Actuator or HomePilot®) must be logged on to the DuoFern Motion Detector 9484.





To do so, please read the instruction manual for the respective DuoFern device.

### **Maximum number of connected devices**

You can assign a maximum of 20 DuoFern devices to a DuoFern Motion Detector 9484.

1. Switch the desired DuoFern device to the registering mode (please refer to the relevant instruction manual).

2.  +  1 sec. Enable the registering mode of the DuoFern Motion Detector 9484. Simultaneously press and hold the buttons for 1 second.

 120 sec. The registering mode remains active for approx. 120 seconds

3.  During the registering process, the middle indicator light flashes green.

4.  After successful registration, the middle indicator light lights up for approx. 4 seconds and the connected appliance is briefly switched on or off.

5. Register the next DuoFern device.  
For this, repeat points 1 to 2 or terminate the registration.



### Pay attention to the middle indicator light





The middle indicator light lights up red if the registration process fails, for example if:

- ◆ 20 DuoFern transmitters have already been registered
- ◆ An unsuitable device is registered

1. Switch the desired DuoFern device to the log-off mode (please refer to the relevant instruction manual).

2.  +  1 sec. Enable the log-off mode of the DuoFern Motion Detector 9484. Simultaneously press and hold the buttons for 1 second.

 120 sec. The log-off mode remains active for approx.120 seconds.

3.  During the logging off process, the middle indicator light flashes red.

4.  After successful logging off, the middle indicator light lights up for approx. 4 seconds and the connected appliance is briefly switched on or off.

5. Log off the next DuoFern device.  
For this, repeat points 1 to 2 or terminate the log-off.

### Pay attention to the middle indicator light





The middle indicator light lights up red if the registration process fails, for example if:

- ◆ An attempt was made to log-off a DuoFern device that is not logged-on.

For your DuoFern Motion Detector 9484 to be set and monitored by the HomePilot®, it must be registered once.

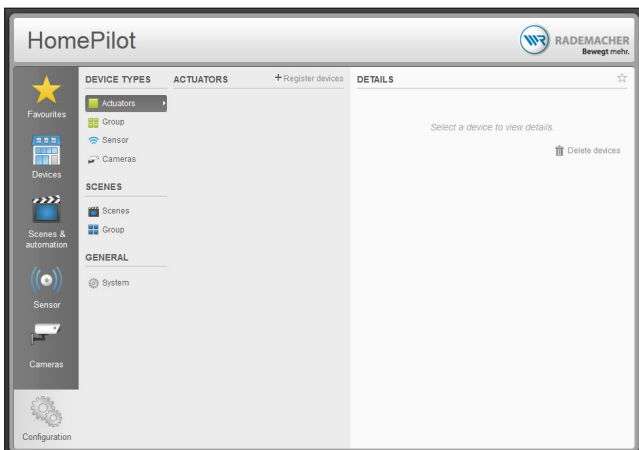
1. Open the use interface of the HomePilot® and click left on the button [**configuration**] and then on [**register device**].



2.  +  1 sec. Enable the registering mode of the DuoFern Motion Detector 9484. Simultaneously press and hold the buttons for 1 second.

3. Both parts of the DuoFern Motion Detector 9484 are displayed individually after logging on successfully. The sensor part and the actuator part can be individually named and marked with symbols.

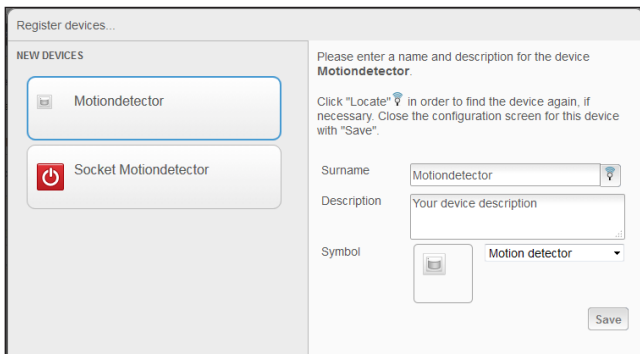

Register devices...

NEW DEVICES

Motiondetector

Socket Motiondetector

Please enter a name and description for the device **Motiondetector**.

Click "Locate" in order to find the device again, if necessary. Close the configuration screen for this device with "Save".

Surname

Description

Symbol

Save

4. Save both parts individually.

The sensor part of the DuoFern Motion Detector 9484 is displayed under "Sensors" with the corresponding status; the actuator part is displayed under "Devices > Switches" and can be controlled directly.



This function enables you to log off all DuoFern devices from the DuoFern Motion Detector 9484 that are no longer accessible via radio.



Not all battery-operated DuoFern transmitters (e.g. the DuoFern manual central operating unit) can be logged off in this way.

A software reset must be carried out in order to logout and delete all DuoFern transmitters, see page 59.

- 
-  1 sec. Enable the clear function.  
Simultaneously press and hold the buttons for 1 second.

---

  -  2. During the logging off process, the middle indicator light flashes red.

---

  -  3. The middle indicator light will light up green for 5 seconds as soon as the clearing process has completed.

### Cancelling the clear function

---

You can cancel the clearing process at any time by briefly pressing any random button.



We recommend resetting the hardware if a unit fails.



All settings remain unaltered when the hardware is reset.

1. Carefully pull the operating unit out of the installation housing.
2. Wait approx. 5 seconds and then carefully reinsert the operating unit into the installation housing.
3. Subsequently check that the DuoFern Motion Detector 9484 is functioning correctly.
4. If the DuoFern Motion detector 9484 is still not reacting, carry out a software reset (see page 59) and test the motion detector with the factory settings.

A software reset can be carried out to reset the DuoFern Motion Detector 9484 to the original default condition as when supplied.

-  Simultaneously press and hold all three buttons for 4 seconds.
-  Release the buttons as soon as the three indicator lights light up red in a constant manner.
- All settings will be erased and reset to the default factory settings. All of the registered DuoFern devices are automatically logged-off.



**There is a risk of fatal electric shocks when touching electrical components.**

- ◆ Disconnect all phases of the mains power supply cable and secure it to prevent any reconnection. Check that the system is de-energised.

1. Log the DuoFern control device off of the DuoFern network.
2. Switch off the mains power, secure it from restarting, and check that the system is de-energised.
3. Carefully pull the operating unit off the installation housing.
4. Remove the frame.
5. Release the claw fasteners of the installation housing and pull it out of the flush-mounted box.
6. Disconnect the connecting cable from the installation housing.
7. Secure the connection point against restarting and the connecting cable from unintentional contact.



RADEMACHER Geräte-Elektronik GmbH hereby declares that the DuoFern Motion Detector 9484 complies with the Directive **2014/53/EU (Radio Equipment Directive)** .

The full text of the declaration of conformity is available at the following website:

[www.rademacher.de/ce](http://www.rademacher.de/ce)

RADEMACHER Geräte-Elektronik GmbH provides a 24-month warranty for new systems that have been installed in compliance with the installation instructions. All construction faults, material defects and manufacturing defects shall be covered by the warranty.

Your statutory warranty claims shall remain unaffected by this warranty.

**The following shall not be covered by the warranty:**

- ◆ Incorrect fitting or installation
- ◆ Non-observance of the installation and operating instructions
- ◆ Improper operation or wear and tear
- ◆ External influences, such as impacts, knocks or weathering
- ◆ Repairs and modifications by third parties, unauthorised persons
- ◆ Use of unsuitable accessories
- ◆ Damage caused by unacceptable excess voltage (e.g. stroke of lightning)
- ◆ Operational malfunctions caused by radio frequency overlapping and other such radio interference

A prerequisite for the warrant is that the new device must have been purchased from one of our approved specialist retailers. Proof of this must be provided by presenting a copy of the bill.

RADEMACHER shall remedy any defects, which occur within the warranty period free of charge either by repair or by replacement of the affected parts or by supplying a new replacement unit or one to the same value. There is no general extension of the original warranty period by delivery of a replacement or by repair as per the terms of the warranty.



## **RADEMACHER**

Geräte-Elektronik GmbH  
Buschkamp 7  
46414 Rhede (Germany)  
info@rademacher.de  
www.rademacher.de

### **Service:**

Hotline 01807 933-171\*  
Fax +49 2872 933-253  
service@rademacher.de

\* 30 seconds free of charge, subsequently  
14 cents / minute from German fixed line  
networks and max. 42 cents / minute from  
German mobile networks.