

## Portable distributor, rubber - UNI - BLOCK, portable



Product description	
BALS-Prd.-Nr	57148
EAN	4024941571487
Product category	UNI - BLOCK, portable
Protection degree	IP44
Colour of appliance	Housing bottom similar black RAL 9017, Housing top similar yellow RAL 1021
Height	171mm
Width	140mm
Depth	140mm

Logistics data	
Weight/pcs	3.266 kg / Piece
Packaging	Carton
Content amount	1 ST
EAN	4024941571487
Length	325 mm
Width	217 mm
Height	210 mm
Weight	3.468 kg
Volume	13,588.4 ccm

Metal surcharges	
Surcharge type	Kupfer
Materialbase	150 EUR per 100 Kilogram
Included weight of material	0.24 Kilogram per 1 Piece

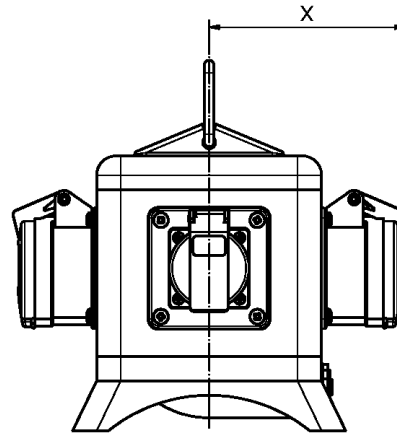
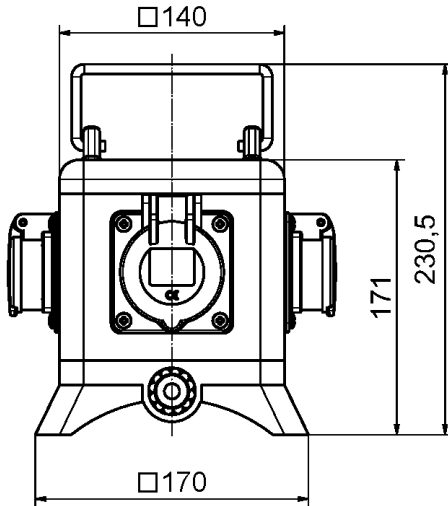

Maße in X

		IP44	IP67	IP54
gerade	16A 3pol.	121	127	
gerade	16A 4pol.	123	128	
gerade	16A 5pol.	127	128	
gerade	32A 3u.4pol.	130	135	
gerade	32A 5pol.	130	130	
geneigt	16A 3pol.	120	127	
geneigt	16A 4pol.	121	127	
geneigt	16A 5pol.	124	130	
geneigt	32A 3u.4pol.	130	135	
geneigt	32A 5pol.	139	139	
gerade	Schuko	98,5	114	106
Absicherungsklappe		90		

