

SCHALTBILDER

DZR 40/2 B

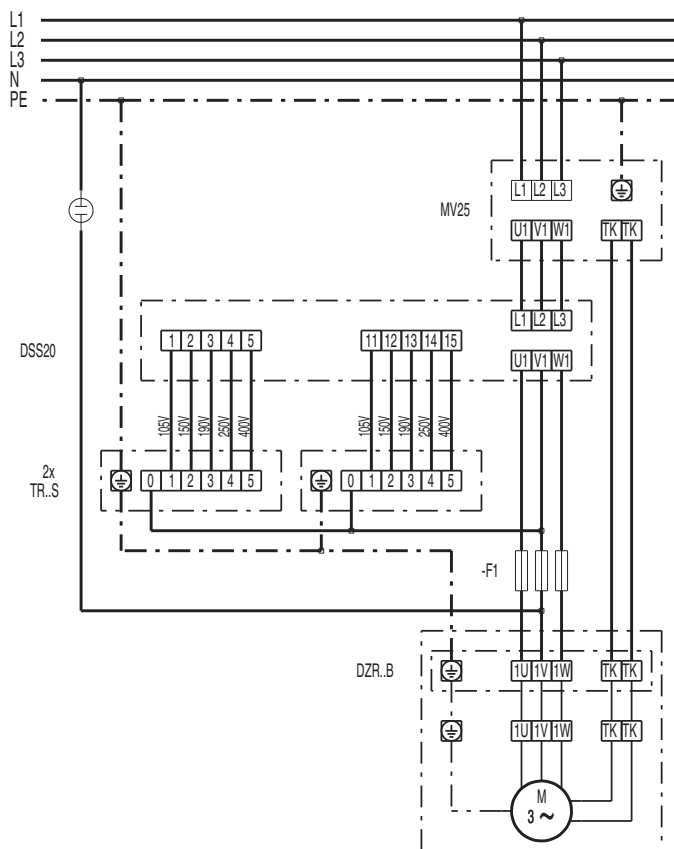

SCHALTBILDER

DZR 40/2 B

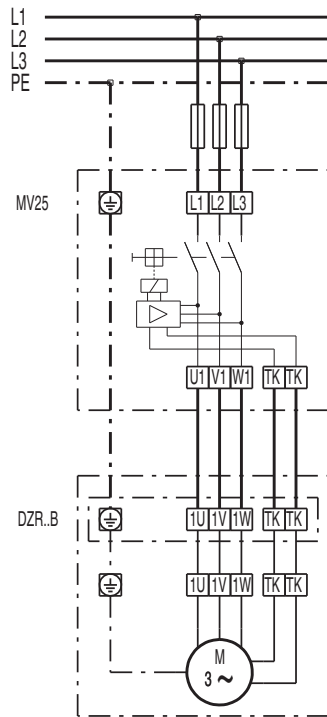

SCHALTBILDER

DZR 40/2 B

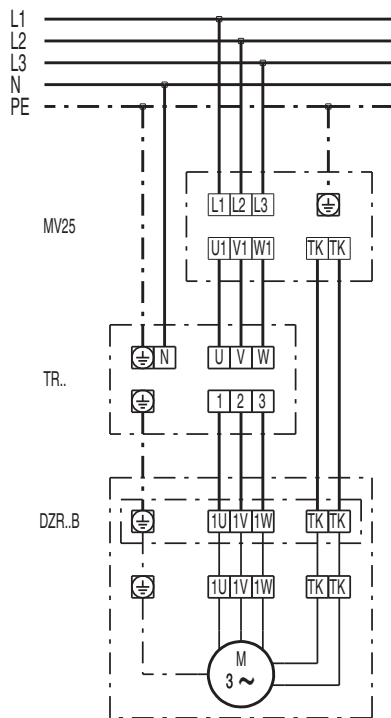

SCHALTBILDER

DZR 40/2 B

