

8

BPS

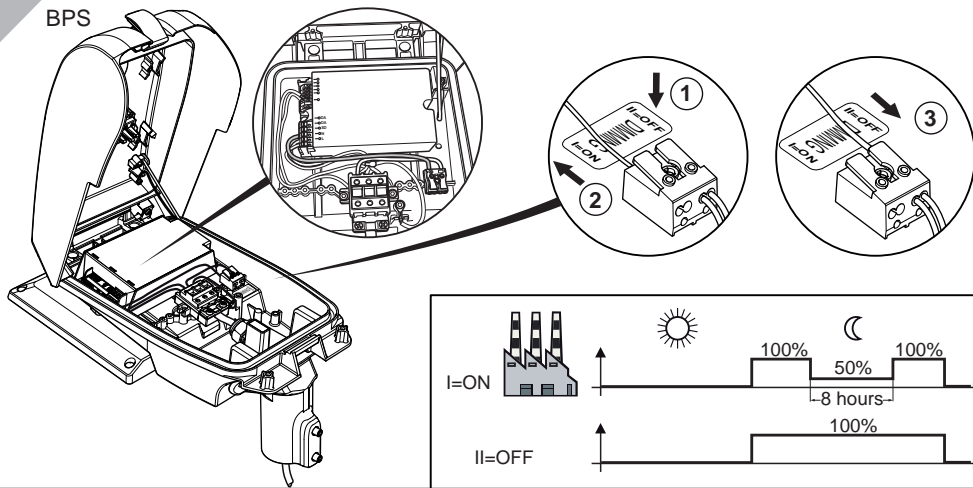
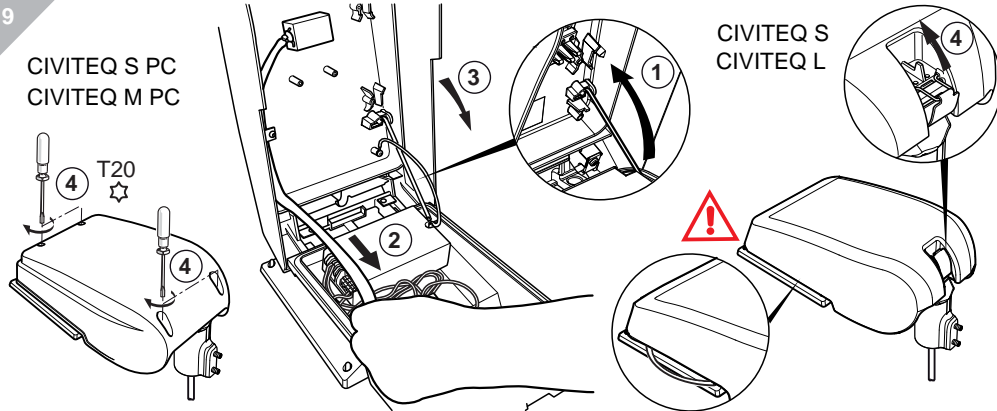

9

CIVITEQ S PC
CIVITEQ M PC

FRANCAIS

-Remplacer toute protection fissurée.
-Les luminaires classe II doivent être installés de façon à ce que la partie métallique ne soit pas en contact avec l'installation électrique connectée à la terre.

ATTENTION: Les luminaires classe I doivent être reliés à la terre.

-Ce luminaire fonctionne à une tension nominale qui doit être coupée avant toute intervention sur l'appareillage.

-Toute modification de cet appareil est interdite.

SVERIGE

-Ersätta alla spräckta skyddsplåtar.
-Klass II armaturer måste installeras så att nakna metalldelar i armaturen inte är i kontakt med någon elektrisk installation, kopplad till en skyddledare.

WARNING: Klass I armaturer måste vara jordade.

-Denna armatur fungerar med högspänning som måste vara fränslagen före ingripande i driftiden.

-Alla ändringar i denna armatur är förbjuden.

ITALIANO

-Sostituire sempre tutte le protezioni danneggiate.
-Gli apparecchi in classe II devono essere installati in modo che le parti metalliche non siano in contatto con apparati elettrici collegati a terra.

ATTENZIONE: Gli apparecchi in class I devono essere collegati a terra.

-Questo apparecchio funziona a tensione nominale, questa deve essere interrotta prima di ogni intervento sul gruppo di alimentazione.

-Ogni modifica dell' apparecchio è proibita.

ENGLISH

-Replace any cracked protective shield.
-Class II luminaires must be installed so that exposed metal work of the luminaire is not in contact with any part of the electrical installation connected to a protective conductor.

WARNING: Class I luminaires must be earthed.

-This luminaire operates at mains voltage which must be switched off before intervention in control gear.

-Any modification to this luminaire is forbidden.

DEUTSCH

-Ersetze jede gebrochene Schutzscheibe.
-Schutzklasse II Leuchten müssen so installiert werden, daß berührbare Metallteile nicht mit einem, an dem Schutzleiter angeschlossenen Teil der elektrischen Installation in Kontakt kommen können.

ACHTUNG: Schutzklasse I Leuchten müssen geerdet sein.

-Diese Leuchte wird mit Netzspannung betrieben. Bevor Eingriffe am Vorschaltgerät vorgenommen werden sowie vor Wartung und Installation, ist die Versorgungsspannung abzuschalten.

-Jede Änderung an dieser Leuchte ist verboten.

SUOMI

-Rikkoontunut suoja-lasi vaihdettava välittömästi uuteen vastaavaan.
-Asennettaessa suoja-luokan II valaisinta on peruseristetyin johdon ja koskettel-tavien metalliosien välinen kosketus tehokkaasti eristettävä.

VAROITUS: Suoja-luokan I valaisin täytyy maadoittaa.

-Verkköjännite on kytkettävä pois ennen valaisimen huoltotoimenpiteitä.

-Valaisimen rakennetta ei saa muuttaa.

CIVITEQ

THORN

UK Installation instructions

DE Montageanleitung

CZ Montážní návod

DK Monteringsvejledning

EE Paigaldusjuhend

FI Asennusohje

FR Notice de montage

HU Szerelési útmutató

IT Istruzioni di montaggio

LT Montavimo Instrukcijos

LV Instalācijas instrukcija

NO Monteringsanvisning

PL Instrukcja montażu

SE Installationsanvisning

RU ИНСТРУКЦИЯ ПО МОНТАЖУ

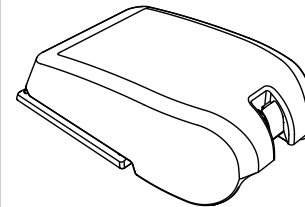
TYPE : CIVITEQ S CIVITEQ S PC
CIVITEQ L CIVITEQ M PC

CIVITEQ S

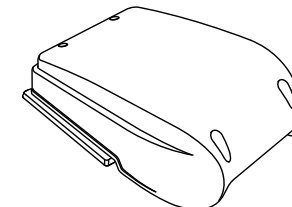

CIVITEQ S PC

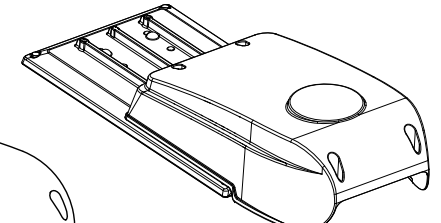

CIVITEQ M PC

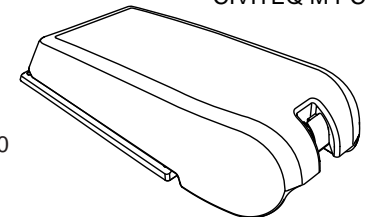

CIVITEQ L



13



4

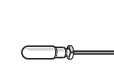

T20



LED

CLASS I

CLASS II

IK08

CE

IP66

IP66

1



CIVITEQ RF

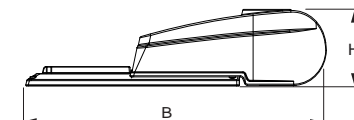
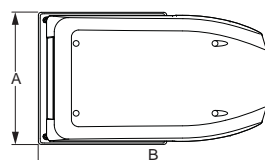
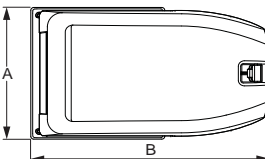
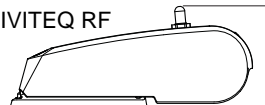

The light source of this luminaire is not replaceable; when the light source reaches its end of life the whole brick shall be replaced



The luminaire with clear optic should be positioned so that prolonged staring into the luminaire at a distance <1.5 m is not expected.

CIVITEQ

	A mm	B mm	H mm	H1 mm	(kg)	SCx
	230	590	135	165	7,8	0,050
	230	580	134	166	9,6	0,074
	230	390	133	165	5,7	0,045
	230	390	133	165	4,8	0,045

