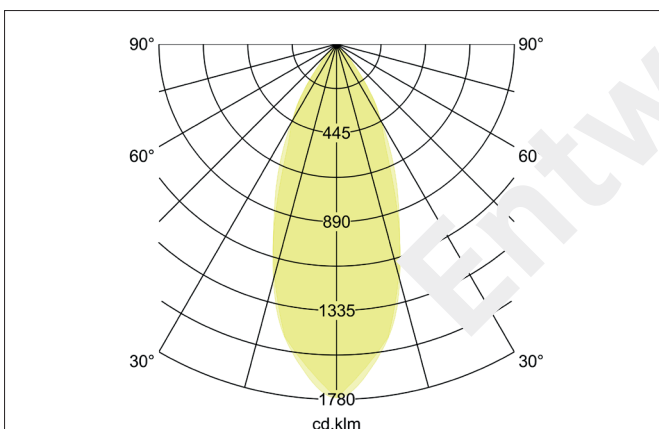
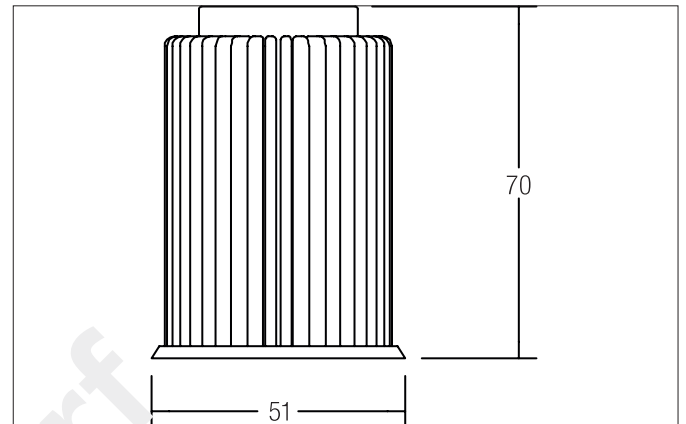

**LED reflector insert MR16, 12 W, dim2warm**  
 Artikel-Nr. 12965003

 Licht.  
 Für Generationen.

**Tender**

LED reflector insert MR16, 12 W, dim2warm, round If the LED module is dimmed, the color temperature is reduced. Lamp holder: Plug&Play, Material: Aluminium / Glass, Degree of protection: according to DIN EN 60529 IP20, Protection class: (EN 61140) III, Current: 350 mA, Power: 12W, Luminous flux: 930lm, Colour temperature: from 3000 K to 1800 K, Beam angle: 38°.

Article data	
Artikel-Nr.	12965003
GTIN	4250047797814
Kurzbeschreibung	LED reflector insert MR16, 12 W, dim2warm
Material	Aluminium / Glass
Shape	round
Outer diameter	50 mm
Aufbauhöhe	70 mm
weight	0.138 kg

Lighting technology	
Colour temperature	3000 K - 1800 K
Light colour	White
Luminous flux	930 lm
Colour rendering	CRI > 90
Reflector	High-gloss
Beam angle	38 °
Light sharing	Symmetric









**LED reflector insert MR16, 12 W, dim2warm**

Artikel-Nr. 12965003

Licht.  
Für Generationen.

Packing data	
Gross weight	0.157 kg
Length of packaging	60 mm
Packaging width	60 mm
Packaging height	83 mm

Accessories	
	<p>Artikel-Nr.: 17613000            Kurzbeschreibung: LED converter 350 mA, on/off            Leistung: 1 - 15 W            Abmessung: 115 mm x 34 mm x 19 mm</p>
	<p>Artikel-Nr.: 17621020            Kurzbeschreibung: LED converter 350 mA, on/off            Leistung: 1 - 21 W            Abmessung: 128 mm x 50 mm x 13 mm</p>
	<p>Artikel-Nr.: 1763020            Kurzbeschreibung: LED converter 350 mA, trailing-edge phase dimmable            Leistung: 0,2 - 17 W            Abmessung: 115 mm x 51 mm x 20 mm</p>
	<p>Artikel-Nr.: 17643020            Kurzbeschreibung: LED converter 350 mA, trailing-edge phase dimmable            Leistung: 8,8 - 18 W            Abmessung: 110 mm x 52 mm x 22 mm</p>
	<p>Artikel-Nr.: 17657000            Kurzbeschreibung: LED converter 350 mA, 1-10 V dimmable (analog)            Leistung: 5,2 - 18 W            Abmessung: 110.5 mm x 52 mm x 22 mm</p>
	<p>Artikel-Nr.: 17683020            Kurzbeschreibung: LED converter 350 mA, DALI dimmable (digital)            Leistung: 3,5 - 17 W            Abmessung: 110.5 mm x 52 mm x 22 mm</p>
	<p>Artikel-Nr.: 17648020            Kurzbeschreibung: LED converter 350 mA, trailing-edge phase dimmable            Leistung: 0,7 - 17 W            Abmessung: 166 mm x 46 mm x 34 mm</p>
	<p>Artikel-Nr.: 17671020            Kurzbeschreibung: LED converter 350mA, ZigBee dimmable            Leistung: 3,5 - 18,5 W            Abmessung: 146.5 mm x 44 mm x 30 mm</p>
	<p>Artikel-Nr.: 17672020            Kurzbeschreibung: LED converter 350mA, Casambi dimmable            Leistung: 3,5 - 18 W            Abmessung: 146.5 mm x 44 mm x 30 mm</p>