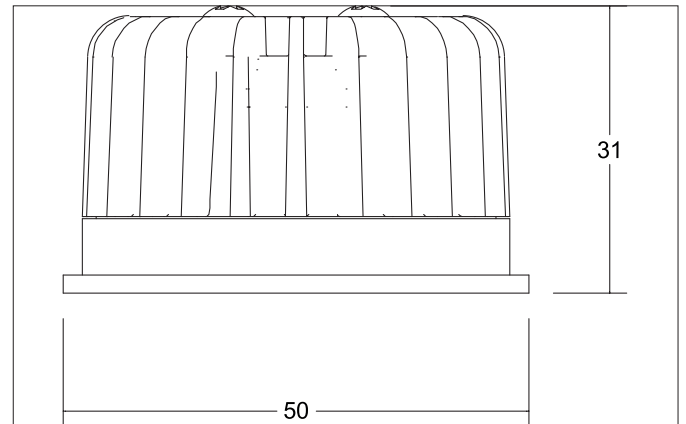

**DISC LED insert, MR16, 6 W, with lens optics, 350 mA**  
Article no. 12920604Light.  
For Generations.**Tender**

LED insert DISC, MR16, 6 W, with lens optics, round. Lamp holder: Plug&Play, Material: Aluminium / Plastic, Degree of protection: according to DIN EN 60529 IP20, Protection class: (EN 61140) III, Current: 350 mA, Power: 6W, Amount of light sources / fittings: 1.0 Qty, Luminous flux: 660lm, Colour temperature: 4.000 K, Beam angle: 60°, Control: Dimming depending on driver.

**Article data**

Article no.	12920604
GTIN	4251433926603
Series name	DISC
Short description	LED insert, MR16, 6 W, with lens optics, 350 mA
Material	Aluminium / Plastic
Shape	Round
Outer diameter	50 mm
Height	31 mm
Weight	0.061 kg

**Lighting technology**

Colour temperature	4000 K
Light colour	White
Luminous flux	660 lm
System efficiency	110 lm/W
Colour rendering	CRI > 80
Luminaire optics	Lens
Beam angle	60°
Light sharing	Symmetric

**DISC LED insert, MR16, 6 W, with lens optics, 350 mA**

Article no. 12920604

Light.  
For Generations.









Operating technology of the luminaire	
System output	6 W
Voltage type	DC
Current	350 mA
Lamp	LED
Lamp holder	Plug&Play
Protection class	III
Degree of protection	IP20
Control	Dimming depending on driver
Bulb change possible	Yes
Rated life time L80/B20 at 25 °C	50.000 h

Packing data	
Gross weight	0.072 kg
Length of packaging	55 mm
Packaging width	55 mm
Packaging height	65 mm
Disposal at end of life	This product must not be disposed of with household waste. You are obliged, to dispose of such electrical waste separately. By disposing of electrical waste and other old or defective electronics separately, you support recycling or other forms of re-use. In that way you help to take care and to avoid that harmful substances get into the environment.

**DISC LED insert, MR16, 6 W, with lens optics, 350 mA**

Article no. 12920604

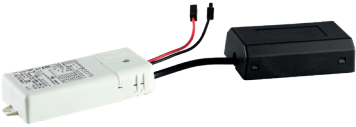
Light.  
For Generations.

Accessories	
	Article no.: 17662020 LED converter 350 mA, on/off switchable Leistung: 1 - 7,2 W Abmessung: 68 mm x 35 mm x 21 mm
	Article no.: 17613000 LED converter 350 mA, on/off switchable Leistung: 1 - 15 W Abmessung: 115 mm x 34 mm x 19 mm
	Article no.: 17621020 LED converter 350 mA, on/off switchable Leistung: 1 - 21 W Abmessung: 128 mm x 50 mm x 13 mm
	Article no.: 17663020 LED converter 350 mA, trailing-edge phase dimmable Leistung: 2,8 - 7 W Abmessung: 110 mm x 50 mm x 19 mm
	Article no.: 17652020 LED-round converter 350 mA, trailing-edge phase dimmer Leistung: 4,9 - 7 W Abmessung: 51 mm x 24 mm
	Article no.: 17640020 LED converter 350 mA, trailing-edge phase dimmable Leistung: 4,2 - 10 W Abmessung: 102 mm x 38 mm x 21 mm
	Article no.: 17657000 LED converter 350 mA, 1-10 V dimmable (analog) Leistung: 5,2 - 18 W Abmessung: 110 mm x 52 mm x 22 mm
	Article no.: 17683020 LED converter 350 mA, DALI dimmable (digital) Leistung: 3,5 - 17 W Abmessung: 110 mm x 52 mm x 22 mm
	Article no.: 17648020 LED converter 350 mA, trailing-edge phase dimmable Leistung: 0,7 - 17 W Abmessung: 166 mm x 46 mm x 34 mm
	Article no.: 17671020 LED converter 350mA, ZigBee dimmable Leistung: 3,5 - 18,5 W Abmessung: 146 mm x 44 mm x 30 mm