

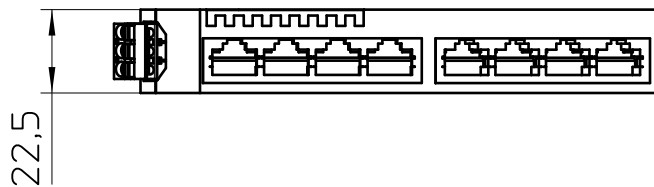

Weitergabe sowie Vervielfältigung dieses Dokuments, Verwertung und Mitteilung seines Inhalts sind verboten, soweit nicht ausdrücklich gestattet. Zuwiderhandlungen verpflichten zu Schadenersatz. Alle Rechte für den Fall der Patent-, Gebrauchsmuster- oder Designeintragung vorbehalten. Bauartbedingtes Spiel ist in den Toleranzangaben nicht berücksichtigt.

Transfer or duplication of this document as well as the utilisation or communication of its content are not permitted unless express consent is granted. Violations give rise to claims for damages. All rights reserved in case of patent, utility model or design patent registrations. Tolerance specifications do not include clearances inherent in the design.

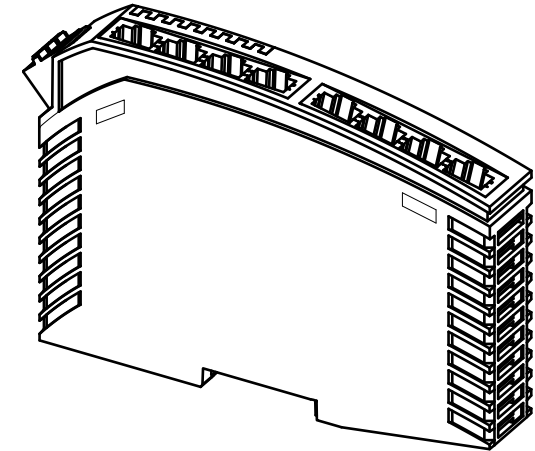
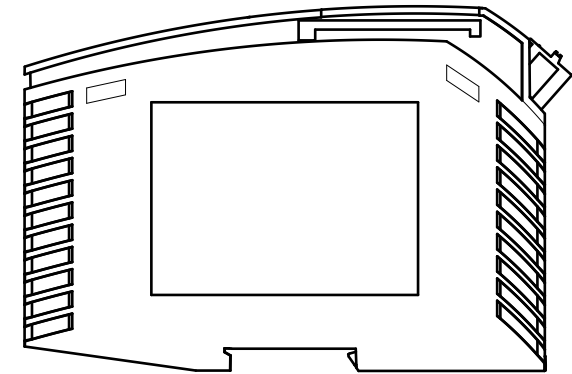
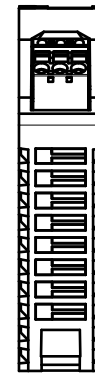
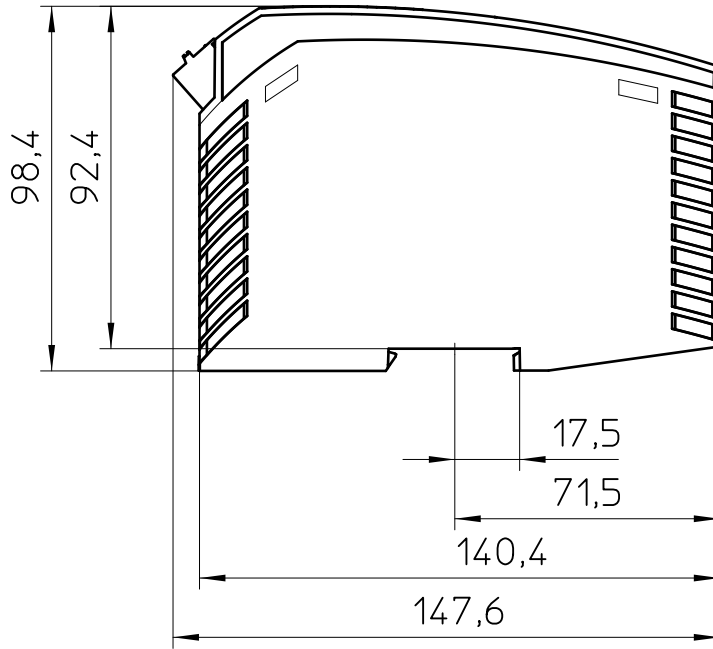
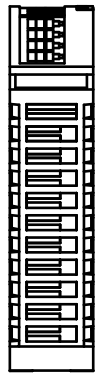
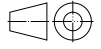

- EN ISO 291 23/50

| | | | | |
|--|-------------------|--------------------------|-------|--|
|  DIN A4 | document-no. / ri | article-no. | scale | - Simplified representation - Document excluded from change process - Linear dimensions [mm] |
| | 01535948 / 00 | 1085243 | 1:2 | |
|  | date | document-type | | |
| | 17.04.2023 | TECDOC 2D_Productdrawing | | |
| page 1 | of 1 | description | | |
| | | FL SWITCH 1108N | | |