

## Panel mounting socket outlet, straight - flange 75x75, fixing centers 60x60



Product description	
BALS-Prd.-Nr	13024
EAN	4024941130240
Product category	Panel mounting socket outlet, straight
Current	32A
Number of poles	3p
Poles	2P+PE
Position of earth contact	6 h
Voltage	200 up to 250V

Product description	
Frequency	50 and 60Hz
Protection degree	IP67
Colour code	blue RAL 5015
Colour of appliance	Hinged lid blue RAL 5015, Bayonet ring grey RAL 7035, Enclosure grey RAL 7035
Connection design	with screw terminal
Maximum conductor size	10,0 qmm
Cable entry	other
Height	97mm
Width	93.5mm
Depth	101mm
Flange size vertical	75mm
Flange size horizontal	75mm
Drill hole distance vertical	60mm
Drill hole distance horizontal	60mm
Material of enclosure	Polyamide
Contact	The contact carrier is made of polyamide, The contacts are brass

Logistics data	
Weight/pcs	0.225 kg / Piece
Packaging	Bag
Content amount	1 ST

Logistics data	
EAN	4024941130240
Length	101 mm
Width	93.5 mm
Height	97 mm
Weight	0.226 kg
Volume	916.02 ccm
Packaging	Carton
Content amount	10 ST
EAN	4024941968263
Length	258 mm
Width	183 mm
Height	212 mm
Weight	2.402 kg
Volume	8,750 ccm

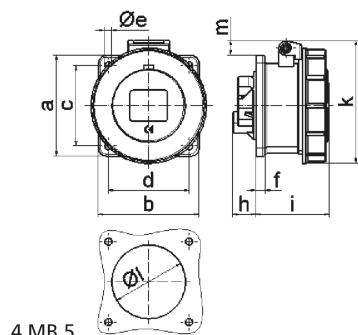

Ampere Polzahl	16 3	16 4	16 5	32 3	32 4	32 5
a	75,0	75,0	75,0	75,0	75,0	75,0
b	75,0	75,0	75,0	75,0	75,0	75,0
c	60,0	60,0	60,0	60,0	60,0	60,0
d	60,0	60,0	60,0	60,0	60,0	60,0
e ø	5,5	5,5	5,5	5,5	5,5	5,5
f	7,0	7,0	7,0	8,0	8,0	8,0
h	17,0	26,0	17,0	36,0	36,0	19,0
i	57,0	58,0	57,0	65,0	65,0	65,0
k	76,0	83,0	93,0	100,0	100,0	106,0
l ø	45,0	45,0	55,0	60,0	60,0	60,0
m	3,5	7,0	11,5	12,0	12,0	17,0
Leiter mm <sup>2</sup> min	1,5	1,5	1,5	2,5	2,5	2,5
Leiter mm <sup>2</sup> max	4	4	4	10	10	10