

Artikel-Nr.	2732v
Bezeichnung	CEE-Kupplung 32A 3p 24VAC 50/60Hz IP67 TWIST
Langbeschreibung	CEE-Kupplung 32A 3p 24VAC 50/60Hz IP67 TWIST Gehäusematerial: PA6 Nennstrom: 32A Polzahl: 3 (3P) Nennspannung/Frequenz: 24V~ / 50+60Hz Kontakte: Messing vernickelt Anschlusstechnik: Schraubklemmen Schutzart: IP67
GTIN (EAN)	9003399059841
Ursprungsland	AT
Zolltarifnummer	85366990
Nettogewicht	0,214 kg
Verpackungsmenge	10
Mindestbestellmenge	10

ETIM 9.0	EC001320
IEC-Stromstärke	32 A
Polzahl	3
Spannung nach EN 60309-2	20-25 V (50+60 Hz) violett
Schutzart (IP)	IP67
Anschlusstechnik	Schraubklemme
Steckrichtung	gerade
Kabeleinführung	Verschraubung
Werkstoff	Kunststoff

a	150 mm
b	78 mm
K (Kabel Ø)	9,5-24 mm
SW	48 mm
Leitung flexibel	1-10 mm ²
Kontaktschrauben	160 Ncm
Zugentlastung	600 Ncm
Abmantelungslänge	70 mm
Abisolierlänge	14-16 mm
Umgebungstemperatur	-25 – 40 °C
Temperaturbeständigkeit	-25 – 80 °C

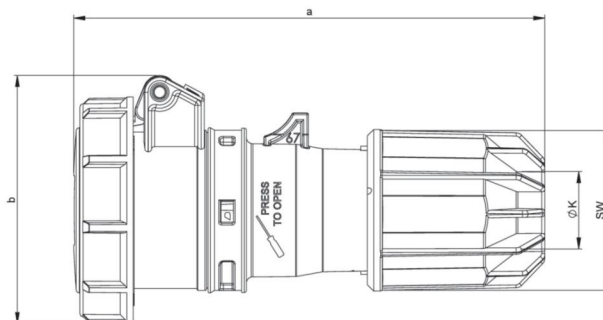

<https://www.pcelectric.at/shop/de/?func=detail&artnr=2732v>

