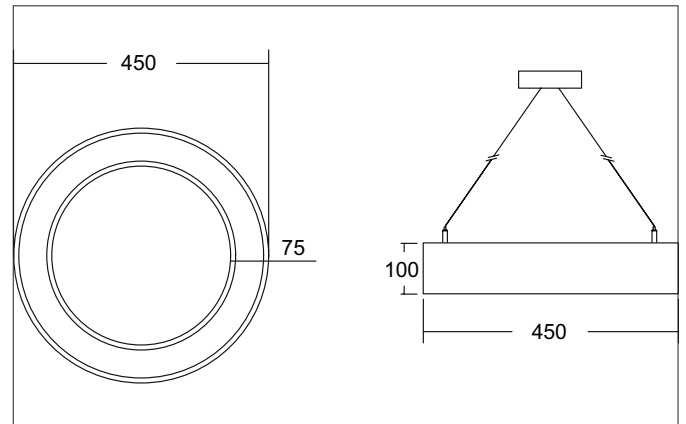

BIRO CIRCLE LED pendant ring light, direct, dimmable

Article no. 13555168CA

Light.
For Generations.**Tender**

LED pendant ring light, direct, dimmable, Round. Ceiling cut-out Installation depth mm, Outer diameter 450 mm, Weight 3,000 kg, with rotationssymmetrical, deep, wide distributed light intensity. optimal light distribution due to a plastic, opal cover. Luminous flux 6.243 lm, Power 1 x 45 W, Light colour warm white to daylight white, Correlated color temprature (CCT) 2.700 - 6.500 K, Colour rendering index CRI > 80, Rated life time L70/B50 at 25 °C: 276.000 h, Rated life time L80/B20 at 25 °C: 153.000 h, Housing material: Aluminium / Steel / Plastic, Colour: Silver structure, Permissible ambient temperature (ta): -20 °C - +25 °C, Protection class (EN 61140): I, Degree of protection (DIN EN 60529): IP20, .With electronic driver, Tunable White-Casambi dimmable.

Article data	
Article no.	13555168CA
GTIN	4251433962991
Series name	BIRO CIRCLE
Short description	LED pendant ring light, direct, dimmable
Material	Aluminium / Steel / Plastic
Colour	Silver
Type of surface	Structure
Shape	Round
Outer diameter	450 mm
Height	100 mm
Scope of delivery	incl. converter for connection to 230 V mains voltage
Weight	3.000 kg

BIRO CIRCLE LED pendant ring light, direct, dimmable

Article no. 13555168CA

Light.
For Generations.

Lighting technology	
Colour temperature	2.700 K bis 6.500 K
Light colour	White
Light output	Direct/Indirect
Luminous flux	6,243 lm
Lichtstromanteil (direkt / indirekt)	70/30 %
System efficiency	139 lm/W
McAdam-Step	McAdam-Step 3
Colour rendering	CRI > 80
Reflector	Without
Beam angle	110°
Light sharing	Symmetric
Adjustable color temperature	No

Operating technology of the luminaire	
System output	45 W
Voltage type	AC
AC nominal voltage max	230 V
Frequenz max.	50 Hz
Lamp	LED
Protection class	I
Degree of protection	IP20
Control	Tunable White-Casambi
Bulb change possible	The light source of this luminaire may only be replaced by the manufacturer or a service technician commissioned by him or a similarly qualified person.
Rated life time L70/B50 at 25 °C	276,000 h
Rated life time L80/B20 at 25 °C	153.000 h
Rated life time L90/B10 at 25 °C	74.000 h

Mounting technology	
Mounting method	Suspended
Place of installation	Ceiling-mounted
Adjustability	Not adjustable
Pendulum length max.	5,000 mm
Material cover	Plastic, opal
Anzahl der Seilabhangung	3

Packing data	
Gross weight	3.5 kg
Length of packaging	480 mm
Packaging width	480 mm
Packaging height	110 mm
Disposal at end of life	This product must not be disposed of with household waste. You are obliged, to dispose of such electrical waste separately. By disposing of electrical waste and other old or defective electronics separately, you support recycling or other forms of re-use. In that way you help to take care and to avoid that harmful substances get into the environment.