

TOM VARIO LED IP66



EN	Installation Instructions	IT	Istruzioni di montaggio
DE	Montageanleitung	LT	Montavimo Instrukcijos
CZ	Montážní návod	LV	Instalācijas instrukcija
DK	Monteringsvejledning	NO	Monteringsanvisning
EE	Paigaldusjuhend	PL	Instrukcja montażu
FI	Asennusohje	SE	Installationsanvisning
FR	Notice de montage	RU	Инструкция по монтажу
HU	Szerelési útmutató	SRB	Instrukcija za instalaciju
HR	Uputstvo za montažu	SK	Montážny návod
NL	Montagehandleiding	SLO	Navodilo za montažo
RO	Instructiuni de montaj	CN	安装说明书



1. Installation and commissioning may only be carried out by authorized specialists and wired in accordance with the latest IEE electrical regulations or the national standards.
2. Mains power must be switched off before carrying out installation.
3. The manufacturer, shall not be liable for any damage resulting from inappropriate modifications to the luminaire or faulty installation.



4. Light source can't be replaced.
5. Caution, risk of electric shock.
The control gear provides basic insulation between the LV supply and the control circuit

Product Description	Wattage	Photobiological risk group	SAP Code	Φ	H	LF
TOM VARIO LED 300 1200 830/40 WH	14W	RG0	96632237	300	91	160
TOM VARIO LED 300 1200 830/40 MWS WH	14W	RG0	96632238	300	91	160
TOM VARIO LED 300 2000 830/40 WH	20W	RG0	96631714	300	91	160
TOM VARIO LED 300 2000 830/40 MWS WH	20W	RG0	96631715	300	91	160
TOM VARIO LED 300 1200 830/40 BK	14W	RG0	96668718	300	91	160
TOM VARIO LED 300 1200 830/40 MWS BK	14W	RG0	96668719	300	91	160
TOM VARIO LED 300 2000 830/40 BK	20W	RG0	96668716	300	91	160
TOM VARIO LED 300 2000 830/40 MWS BK	20W	RG0	96668717	300	91	160

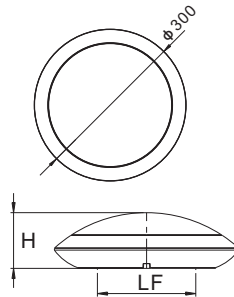

1	x1
2	x2
3	x2
4	x2
5	x2

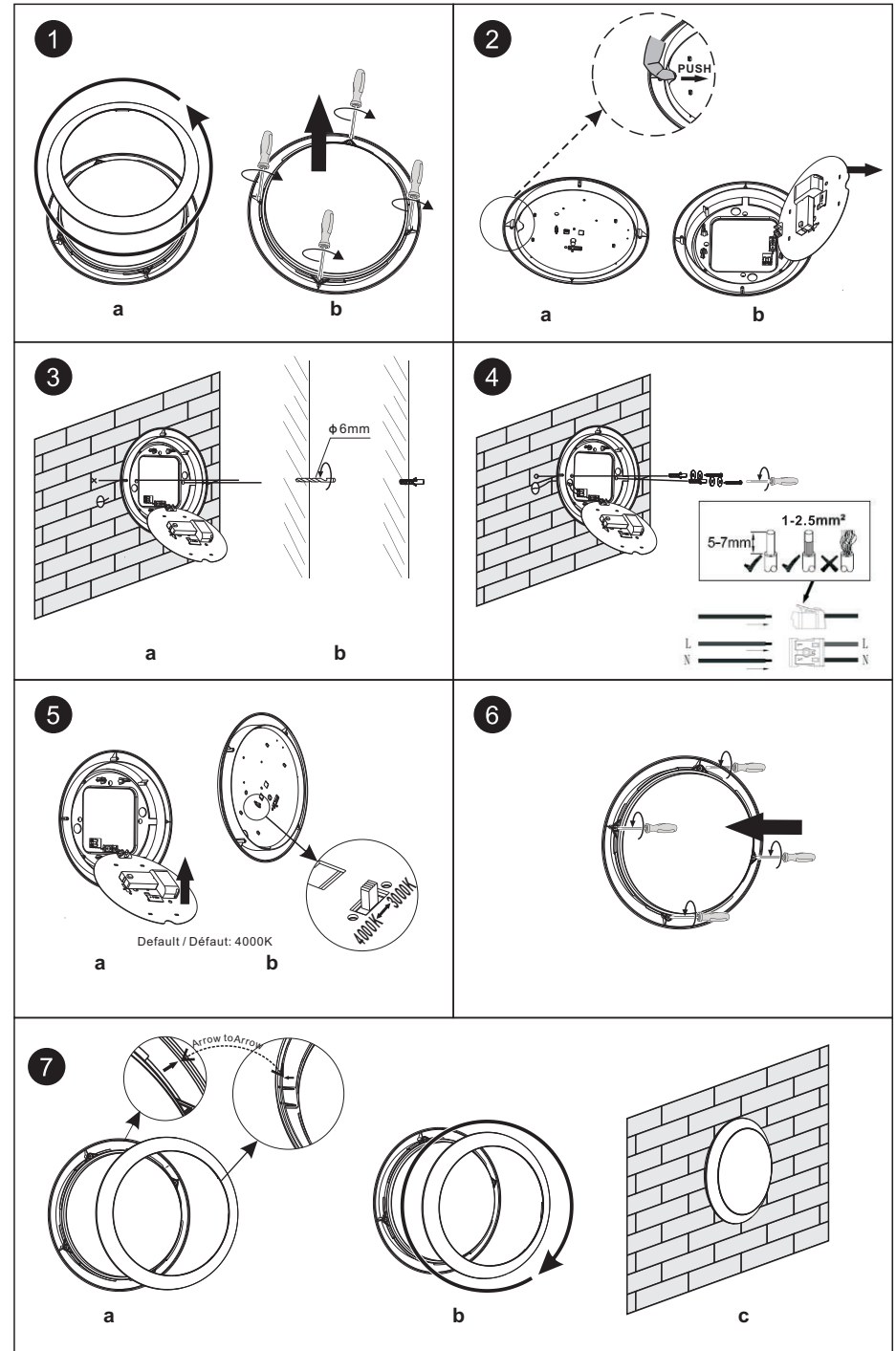
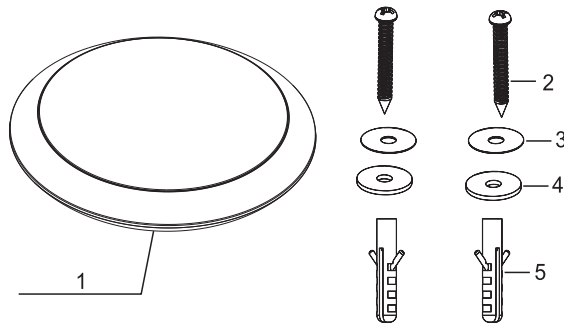

MWS

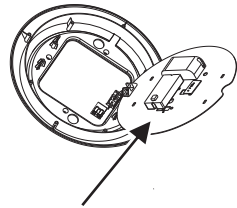

S1 S2 S3 S4 S5 S6 S7 S8

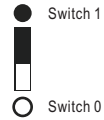
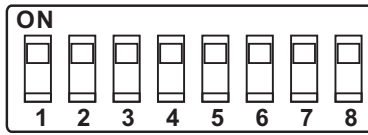

S1	S2	detection range
0	0	20%
0	1	50%
1	0	75%
1	1	100%

S3	S4	S5	TIME
0	0	0	10s
0	0	1	1min
0	1	0	5min
0	1	1	10min
1	0	0	15min
1	0	1	20min
1	1	0	25min
1	1	1	30min

S6	S7	S8	LUX
0	0	0	Disable/désactivé
0	0	1	10LUX
0	1	0	20LUX
0	1	1	50LUX
1	0	0	100LUX
1	0	1	200LUX
1	1	0	300LUX
1	1	1	500LUX

Detection area

Detection area means detection coverage. It can be adjusted by combining DIP switches for specific application.

Champs de détection

Le champs de détection peut être ajustée en sélectionnant la combinaison sur les commutateurs DIP, en fonction de l'application.

Hold-time

Hold-time means the time period the light will be ON after the last detection.

Temps de maintien

Le temps de maintien se réfère à la période de temps durant laquelle la lumière reste à 100% si aucun autre mouvement n'est détecté.

Daylight threshold

Daylight sensor prior to motion sensor. Set threshold for specific needs. If Disable, only motion sensor works.

Capteur de lumière du jour La lumière s'allumera si le niveau de luminosité est inférieur au niveau réglé et qu'une présence est détectée. Si il est au dessus elle ne s'allumera pas. La lumière s'allumera uniquement en cas de mouvement si le capteur de lumière du jour est désactivé.

Default / Défaut

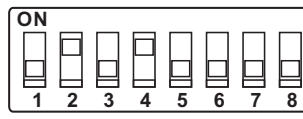

50% 5min Disable/désactivé

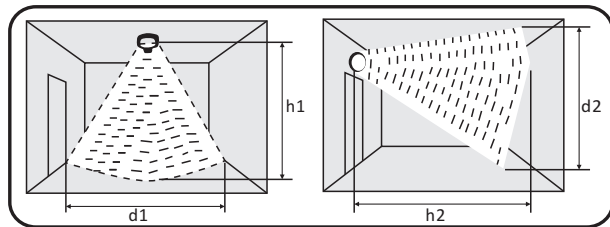

	h1	d1	h2	d2
100%	3.5m	12m	6m	6m
75%	3m	10m	4m	5m
50%	2.5m	7m	2m	3m
20%	1m	2m	1m	1m

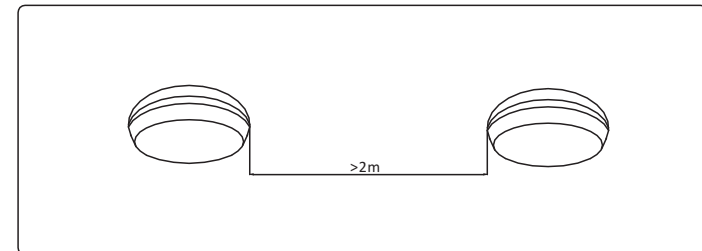
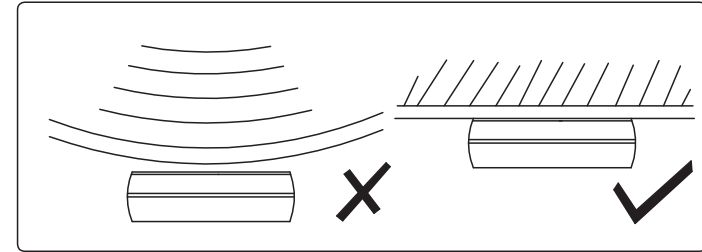
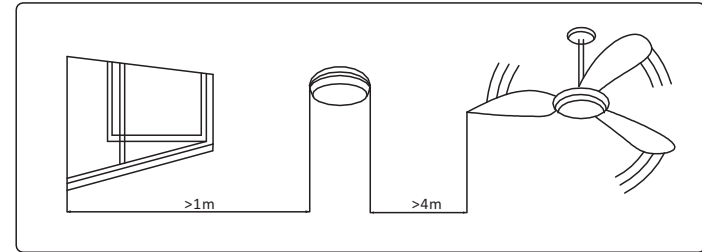
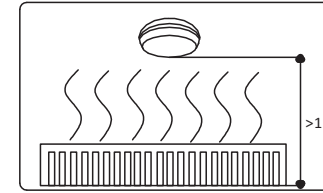

Zumtobel LIGHTING GmbH Schweizer Strasse 30 A-6851 Dornbirn AUSTRIA

URL: www.thorn-eco.com

CE □ IP66 IK10