

Transfer or duplication of this document as well as the utilisation or communication of its content are not permitted unless express consent is granted. Violations give rise to claims for damages. All rights reserved in case of patent, utility model or design patent registrations.

Weitergabe sowie Vervielfältigung dieses Dokuments, Verwertung und Mitteilung seines Inhalts sind verboten, soweit nicht ausdrücklich gestattet. Zuwiderhandlungen verpflichten zu Schadensersatz. Alle Rechte für den Fall der Patent-, Gebrauchsmuster- oder Designeintragung vorbehalten.

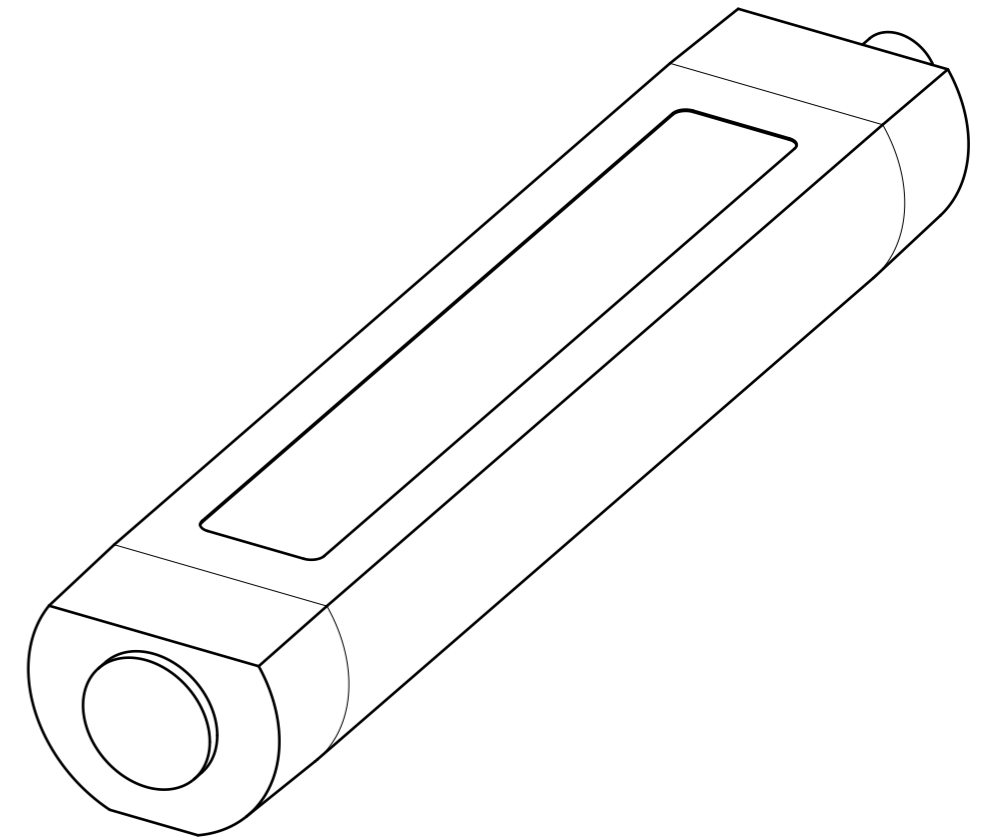
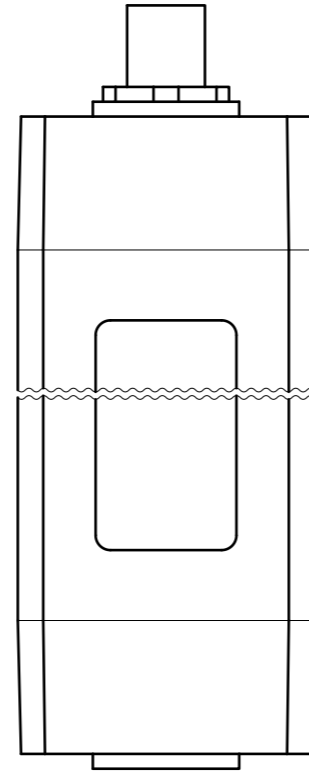
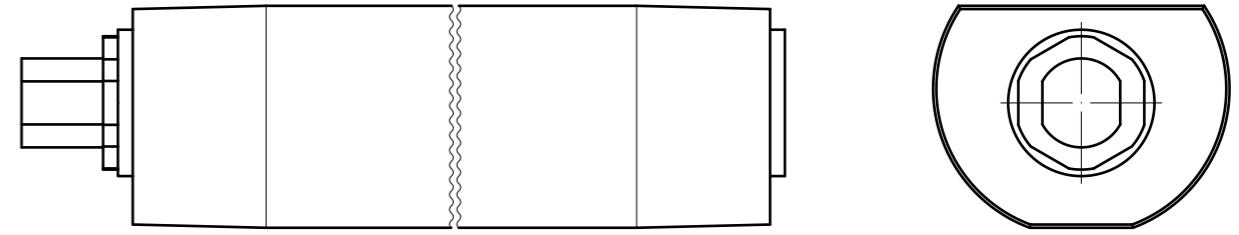
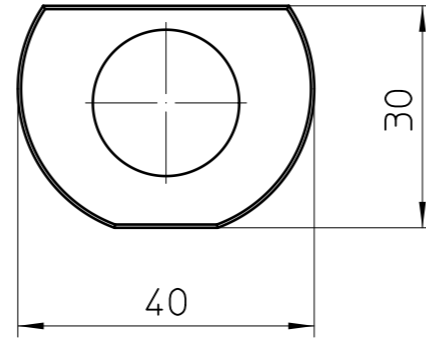
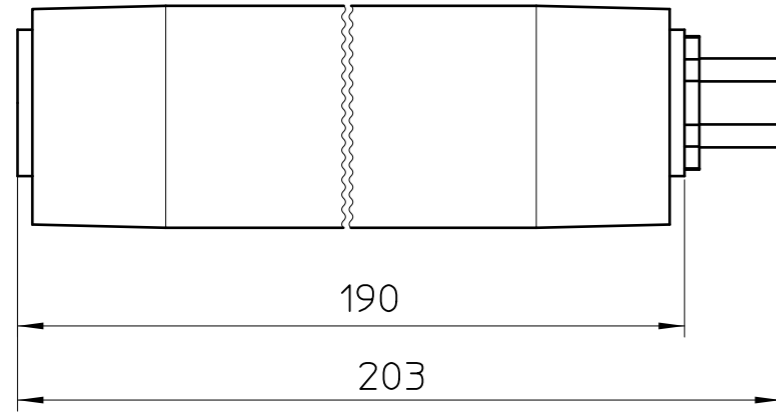

General Information

- Simplified representation
- Document excluded from change process
- Linear dimensions [mm]

	DIN A3	document-No. / RI	00895453 / 01	date	30.07.2019	scale	1:1
		ident.-No.	2702480	document-type	TECDOC 2D_Productdrawing		
description		PLD M 260 W-85/95 190/D40					
page 1	of 1						