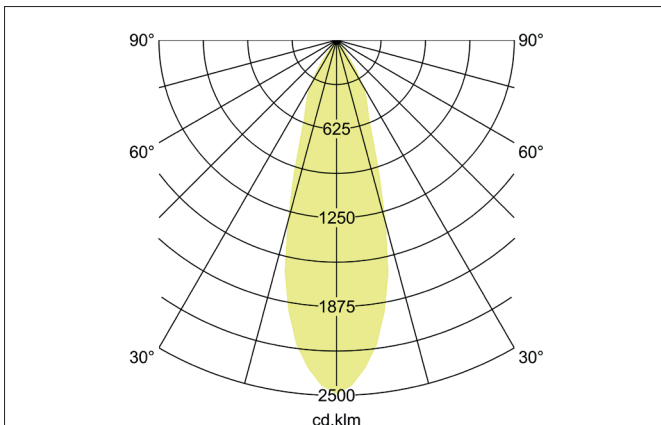
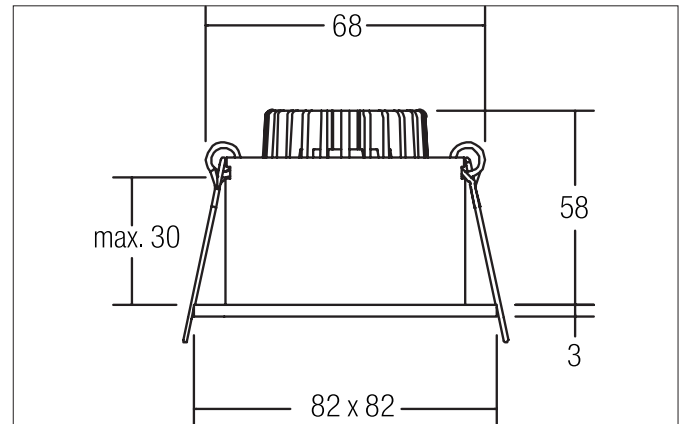

**ETMESA-S LED recessed downlight set, IP54, trailing-edge phase dimmable**

Article no. 39267083

Light.  
For Generations.**Tender**

LED recessed downlight set, IP54, trailing-edge phase dimmable, Square. Toolless ceiling installation by installation springs. Ceiling cut-out Ø 68 mm, Installation depth 58 mm, Length 82 mm, Width 82 mm, Weight 0,248 kg, Reflector silver with rotationssymmetrical, deep, wide distributed light intensity. optimal light distribution due to a glass transparent cover. Luminous flux 540 lm, Power 1 x 6 W, System Efficiency 90 lm/W, Light colour warm white, Correlated color temperature (CCT) 2.700 K, Colour rendering index CRI > 80, Housing material: Aluminium / Glass, Colour: White, Permissible ambient temperature (ta): -20 °C - +25 °C, Protection class (EN 61140): II, Degree of protection (DIN EN 60529): IP54 when installing in closed ceilings. With electronic driver, Trailing-edge phase dimmable.

Article data	
Article no.	39267083
GTIN	4251433952183
Series name	ETMESA-S
Short description	LED recessed downlight set, IP54, trailing-edge phase dimmable
Material	Aluminium / Glass
Colour	White
Type of surface	Matt
Shape	Square
Built-in diameter	68 mm
Installation depth	58 mm
Length	82 mm
Width	82 mm
Height	3 mm
Weight	0.248 kg

**ETMESA-S LED recessed downlight set, IP54, trailing-edge phase dimmable**

Article no. 39267083

Light.  
For Generations.

Lighting technology	
Colour temperature	2.700 K
Light colour	White
Light output	Direct
Luminous flux	540 lm
System efficiency	90 lm/W
Colour rendering	CRI > 80
Reflector	High-gloss
Reflektorfarbe	silver
Beam angle	38°
Light sharing	Symmetric

Operating technology of the luminaire	
---------------------------------------	--

Operating technology of driver	
Length	110 mm
Width	50 mm
Hight	19 mm
AC nominal voltage min	198 V
AC nominal voltage max	264 V
Frequenz max.	50 Hz
Dimmable	Yes
Control	Trailing-edge phase
Starting current	1A (15,2 µs)
Power min	2.8 W
Power	7 W
Current	350 mA
Degree of protection	IP20
Protection class	II
Flickerfrei	Yes

Mounting technology	
Mounting method	Recessed mounting
Place of installation	Ceiling-mounted
Adjustability	Not adjustable
Max. ceiling thickness	30 mm
Further references	No cover with thermal insulation material
Material cover	Glass transparent
Circlip	Without circlip
Suitable for through-wiring	Yes, with optional accessories

Packing data	
Gross weight	0.314 kg
Length of packaging	100 mm
Packaging width	100 mm
Packaging hight	100 mm
Disposal at end of life	This product must not be disposed of with household waste. You are obliged, to dispose of such electrical waste separately. By disposing of electrical waste and other old or defective electronics separately, you support recycling or other forms of re-use. In that way you help to take care and to avoid that harmful substances get into the environment.