

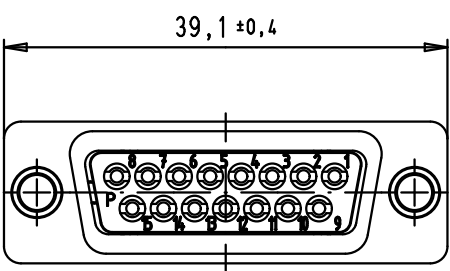

5 4 3 2 1

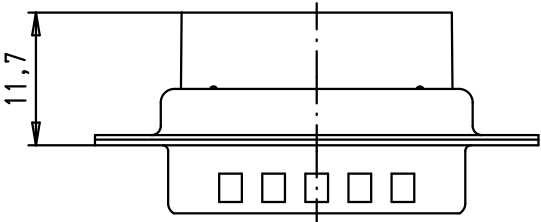

Panel cut out

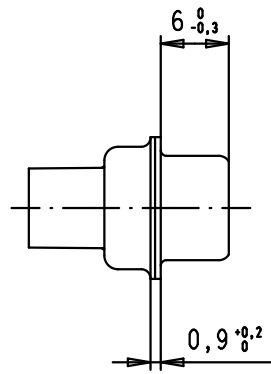
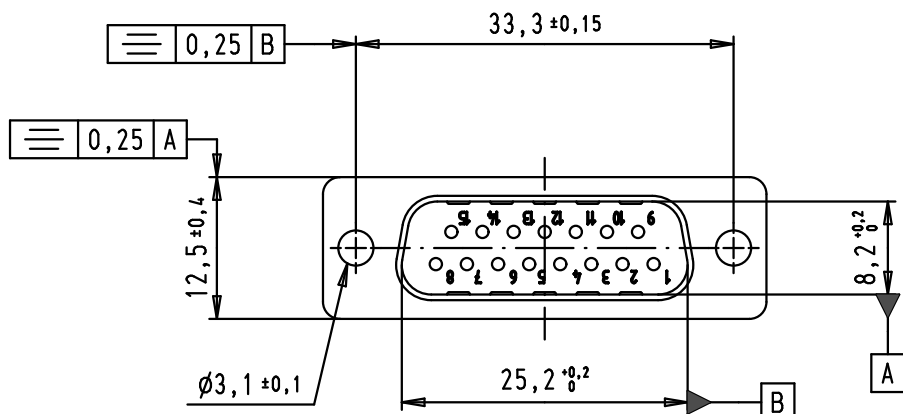
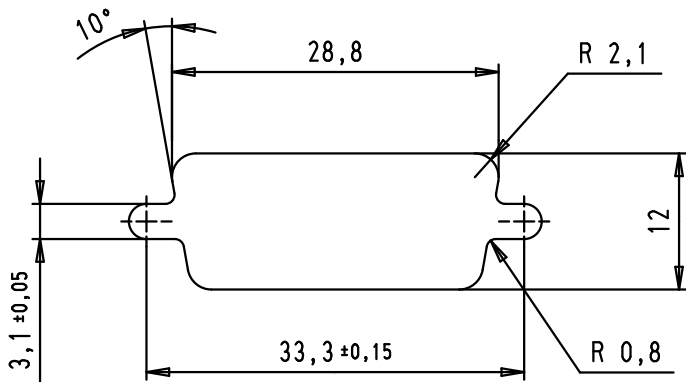

A

Mod.	Dot.	Name	Dot.	Name	 All Dim. in mm Orig. Size DIN A 4	D-Sub, male, straight, 15 poles, for crimp contacts, tin plated shell with dimples	Maßstab/ Scale	
34784	14/02/08	PK	Detail.	09/04/02			CV	TB 09 67 015 5601
33106	22/09/05	JMDR	Insp.			Blatt/ Page 1 / 2		
31571	12/11/03	SH	Stand.					
31526	31/07/03	TCP	HARTING EURL F-95972 Paris					
29768	09/04/02	CV						
						Sub.		