

## Cross distributors - Cross distributor



Product description	
BALS-Prd.-Nr	54569
EAN	4024941545693
Product category	Cross distributor
Protection degree	IP44
Colour of appliance	Housing bottom grey RAL 7035, Housing top grey RAL 7035
Height	118mm
Width	118mm
Depth	80mm

Logistics data	
Weight/pcs	1.354 kg / Piece
Packaging	Carton
Content amount	1 ST
EAN	4024941545693
Length	258 mm
Width	183 mm
Height	212 mm
Weight	1.503 kg
Volume	8,750 ccm

Metal surcharges	
Surcharge type	Kupfer
Materialbase	150 EUR per 100 Kilogram
Included weight of material	0.18 Kilogram per 1 Piece

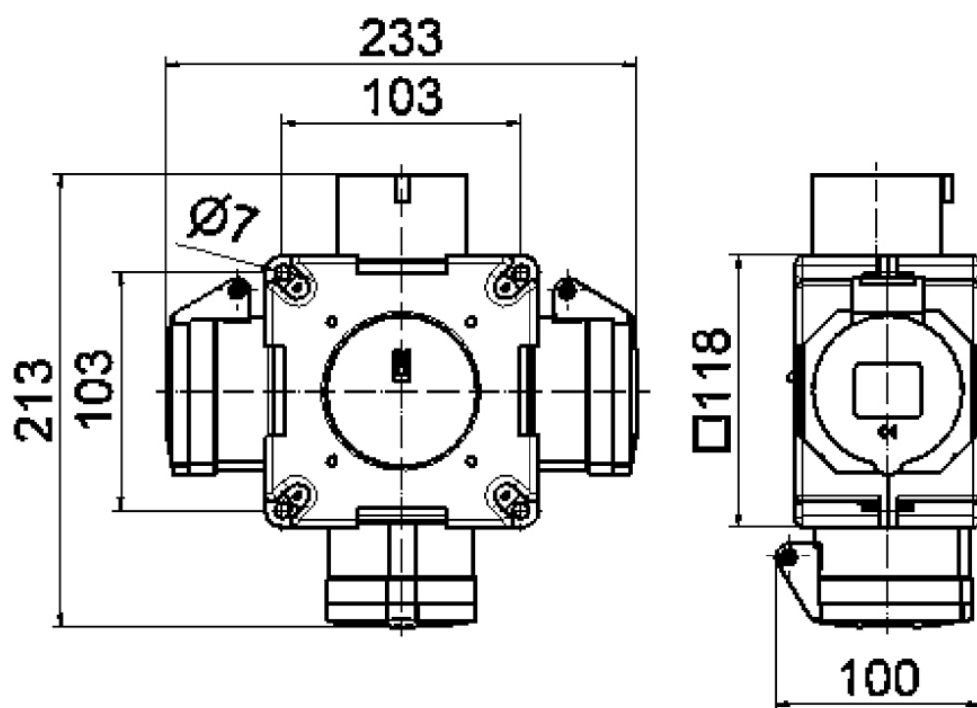

## 30 MB 061