

ESYLUX www.esylux.com

DE MONTAGEANLEITUNG

ACHTUNG: Arbeiten am 230 V-Netz dürfen nur von autorisiertem Fachpersonal unter Berücksichtigung der landesüblichen Installationsvorschriften/-normen ausgeführt werden. Vor der Montage des Produktes ist die Netzspannung freizuschalten.

- Die empfohlene Montagehöhe beträgt 3 m. Mit steigender Montagehöhe wird die Reichweite größer, die Empfindlichkeit wird jedoch kleiner. Die Bewegung quer zum Melder ist optimal für eine Auslösung. Bei einem direkten und frontalen Zugehen ist es für den Melder schwieriger, eine Bewegung zu erkennen, somit ist die Reichweite deutlich geringer.
- Die Platzierung des Melders sollte entsprechend den räumlichen Gegebenheiten und Anforderungen erfolgen (siehe Abbildungen):



Je nach Type den Melder gemäß Anschlussplan anschließen (siehe Rückseite):

GB INSTALLATION INSTRUCTIONS

CAUTION: Work on the 230 V power system must be carried out by authorised personnel only, with due regard to the applicable installation regulations. Before installing the product, switch off the power supply.

- The recommended mounting height is 3 m. The greater the mounting height, the bigger the range, but the lower the sensitivity. Movements diagonal to the detector are optimal for triggering the detector. In the case of a direct and head-on approach, it is more difficult for the detector to detect movement; the range is thus significantly reduced.
- The detector should be positioned according to spatial conditions and requirements (see illustrations):



Connect the detector in accordance with the wiring diagram for the particular type of device (see reverse):

FR INSTRUCTIONS DE MONTAGE

ATTENTION : seules des personnes autorisées et qualifiées pour effectuer une installation conforme aux normes et prescriptions en vigueur peuvent intervenir sur le réseau 230 V. Avant d'installer le produit, coupez le courant.

- Il est recommandé de monter le détecteur à une hauteur de 3 m. En effet, plus il est placé haut, plus sa portée est importante, mais plus sa sensibilité diminue. Le détecteur est plus réactif lorsque le mouvement traversant son champ d'action est transversal par rapport à son rayonnement. En effet, lorsque l'élément s'approche en faisant face au dispositif, le détecteur capte moins facilement ses mouvements, ce qui réduit considérablement son efficacité.
- Le détecteur doit être positionné en tenant compte des particularités et des contraintes de l'espace (voir illustrations) :



Raccorder le détecteur conformément au schéma électrique (voir au dos) :

DK MONTERINGSVEJLEDNING

ADVARSEL: Arbejder på 230 V-nettet må kun udføres af autoriserede fagfolk under overholdelse af nationale installationsforskrifter/-standarder. For montering af produktet skal netspændingen slås fra.

- Den anbefalede monteringshøjde er 3 m. Jo højere udstyret monteres, desto mere øges rækkevidden, men følsomheden aftager. En bevægelse på tværs af sensoren er optimal for en udløsning. Når man går direkte og frontalt ind mod sensoren, er det sværere for den at registrere en bevægelse, hvorfor rækkevidden bliver væsentlig kortere.
- Sensoren bør placeres svarende til rumforholdene og kravene (se billederne):

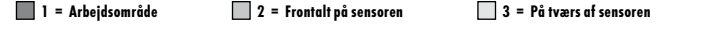

Tilslut sensoren i henhold til tilslutningsplanen alt efter type (se bagsiden):

FI ASENNUSOHJE

HUOMIO: 230 V:n verkossa tehtävien töiden suorittaminen on jätettävä ainoastaan valtuutettujen ammattihenkilöiden tehtäväksi maassa voimassa olevia asennusmääräyksiä/-normeja noudattaen. Ennen tuotteen asentamista on verkkojännite kytkettävä pois päältä.

- Suosittelava asennuskorkeus on 3 m. Suurempi asennuskorkeus lisää kantomatkaa, mutta herkkyyks laskee. Poikittain ilmaiseen suuntautuva liike on ihanteellinen laukaisu varten. Ilmaisn havaitsee suoraan ja edestä tulevan liikkeen vaikeammin ja siten kantomatka on huomattavasti pienempi.
- Ilmaisn on sijoitettava tilallisia olosuhteita ja vaatimuksia vastaavasti (katso kuvat):



Liitä liitäntäkaavion mukaan ilmaisimen tyyppin mukaisesti (katso taustapuoli):

IT ISTRUZIONI DI MONTAGGIO

ATTENZIONE: le operazioni su rete elettrica a 230 V devono essere eseguite esclusivamente da personale autorizzato nel rispetto delle disposizioni e delle norme di installazione locali. Prima dell'installazione del prodotto, togliere l'alimentazione.

- L'altezza di montaggio consigliata è 3 m. La portata aumenta con l'aumentare dell'altezza, mentre la sensibilità diminuisce. Il movimento ottimale per l'azionamento è trasversale rispetto al segnalatore. In caso di movimento diretto e frontale, il rilevatore capta i movimenti con maggiore difficoltà e con una portata inferiore.
- Il rilevatore deve essere posizionato in base alle condizioni e alle esigenze ambientali (vedere figure):



Collegare il rilevatore in base al tipo, rispettando lo schema dei collegamenti (vedere parte posteriore):

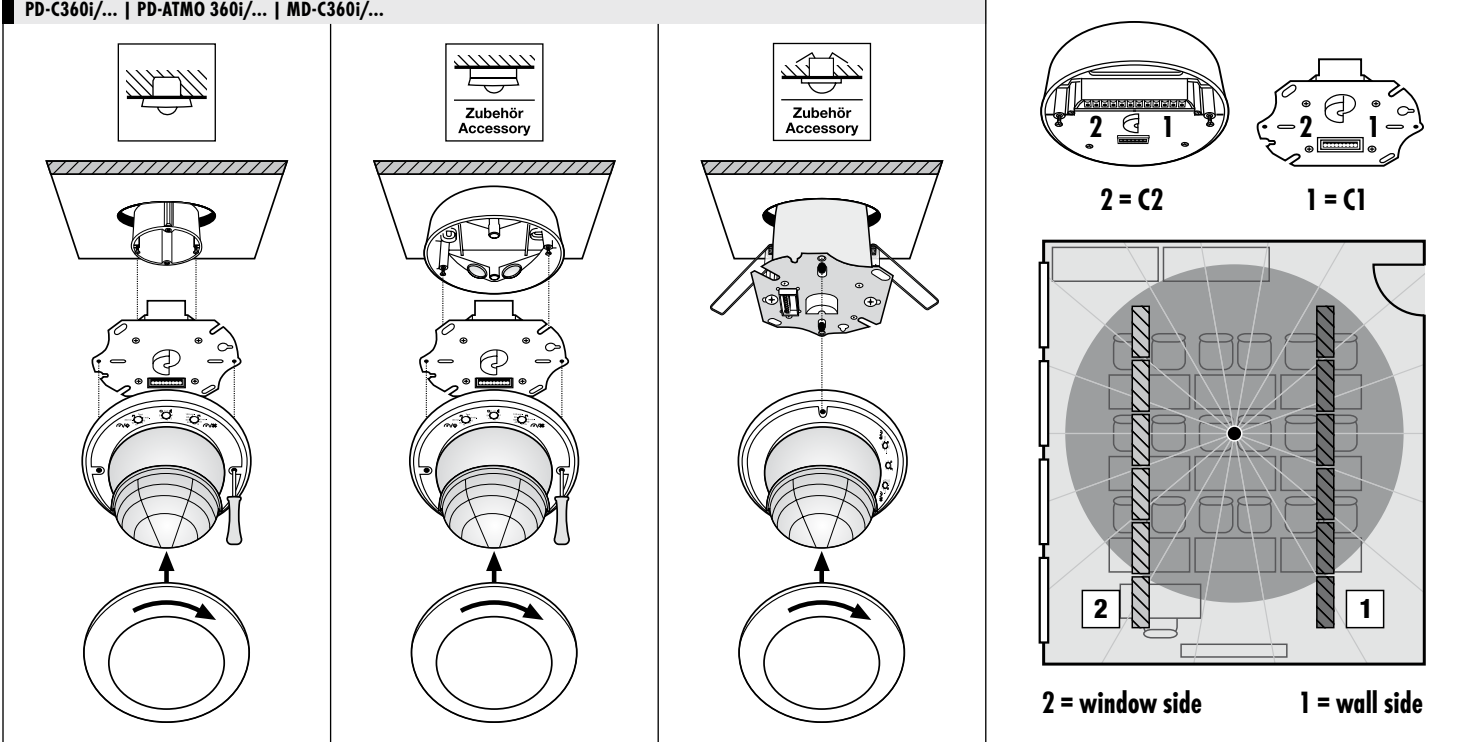

MD-C360i/8... | MD-CE360i/8... | MD-C360i/24 | MD-CE360i/24... | PD-C360i/8... | PD-ATMO 360i/8... | PD-CE360i/8... | PD-C360i/24... | PD-CE360i/24...

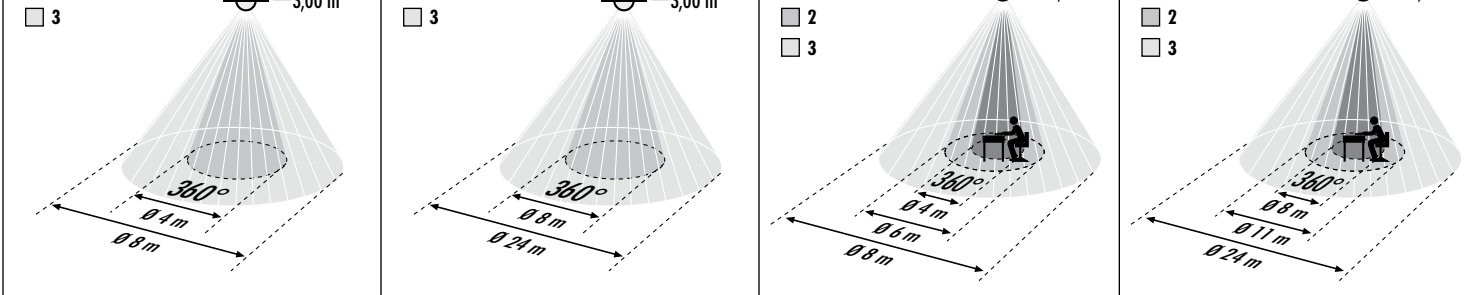

PD-C360i/24... | PD-CE360i/24... • 5 m | PD-C360i/24... | PD-CE360i/24... • 10 m | PD-C360i/24 DIMplus WH | PD-C360/24 Slave WH • approx. 10 m

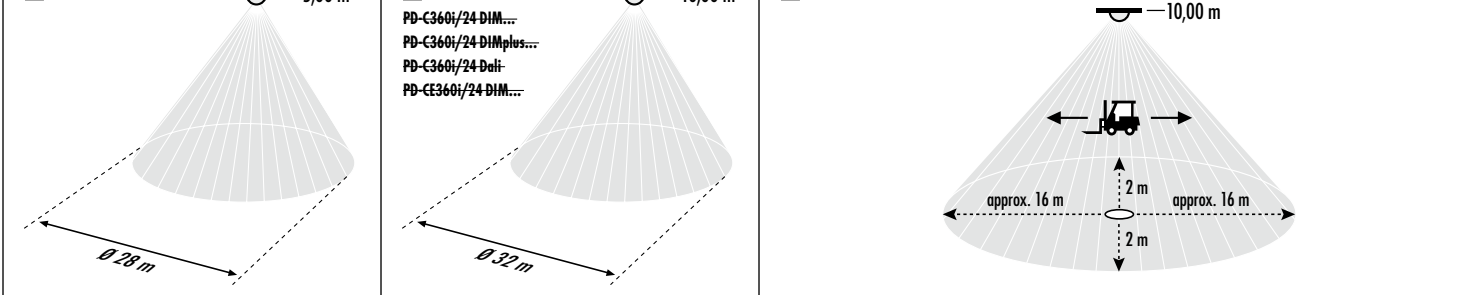

NL MONTAGEHANDLEIDING

LET OP: Werkzaamheden aan het 230V-net mogen uitsluitend door gekwalificeerd vakpersoneel uitgevoerd worden conform de geldende installatievoorschriften/-normen. Voor montage van het product de netspanning uitschakelen.

- De aanbevolen montagehoogte bedraagt 3 m. Hoe groter de montagehoogte des te groter het bereik, maar des te minder ook de gevoeligheid. Beweging dwars op het apparaat is optimaal voor de detectie. Bij een directe en frontale benadering is het voor de sensor moeilijk om beweging te herkennen, waardoor het bereik aanzienlijk kleiner is.
- De plaatsing van de apparaat moet zijn afgestemd op de specifieke omstandigheden en eisen van de ruimte (zie afbeeldingen):



Sluit de melder aan volgens het bijbehorende aansluitschema (zie achterzijde):

SE MONTERINGSANVISNING

WARNING! Allt arbete på 230 volts nätspänning får endast utföras av behörig elektriker under iakttagande av nationella föreskrifter och installationsstandarder. Innan produkten monteras ska nätspänningen kopplas från.

- Den rekommenderade monteringshöjden är 3 meter. Ökad monteringshöjd ger större räckvidd medan känsligheten minskar. Vinkelräta rörelser är optimala för att aktivera detektorn. När en person går rakt fram mot detektorn har systemet svårare att detektera rörelsen, vilket gör att räckvidden minskar betydligt.
- Detektorn ska placeras med hänsyn till de lokala förhållandena och ställda krav (se bilderna):



Anslut detektorn enligt kopplingsdiagrammet, beroende på vilken typ det rör sig om (se baksidan):

NO MONTERINGSVEILEDNING

ADVARSEL: Arbeid i 230 V-nett skal kun utføres av autorisert personell, og nasjonale forskrifter og normer for installasjoner skal følges. Nettspenningen skal koples fra for produktet monteres.

- Anbefalt monteringshøyde er tre meter. Jo større monteringshøyden er, jo større blir rekkevidden. Følsomheten blir imidlertid redusert. Bevegelse på tvers av detektoren er optimalt for en aktivering. Ved direkte og frontal tilnærming er det vanskelig for detektoren å registrere en tilstedeværelse, dermed er rekkevidden merkbart redusert.
- Detektoren bør plasseres i samsvar med forholdene og behovet i rommet (se figurene):



Avhengig av detektortypen koples den til i samsvar med koplingskjemata (se baksiden):

ES INSTRUCCIONES DE MONTAJE

ATENCIÓN: Los trabajos en la red de 230 V solo pueden ser realizados por personal técnico autorizado de conformidad con las normas y los reglamentos de instalación específicos de cada país. Antes de montar el producto, desconecte la tensión de alimentación.

- La altura de montaje recomendada es 3 m. Con una altura de montaje superior, el alcance se amplía, pero la sensibilidad se reduce. El movimiento a los lados del detector es óptimo para la activación. Con un desplazamiento directo y frontal, el movimiento se detecta peor, con lo que el alcance se reduce considerablemente.
- El detector debe colocarse teniendo en cuenta las circunstancias especiales y las necesidades (ver ilustraciones):

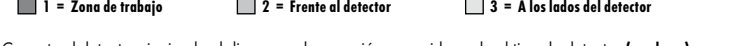

Conecte el detector siguiendo el diagrama de conexión y considerando el tipo de detector (ver dorso):

PD-CE360i/... | MD-CE360i/...

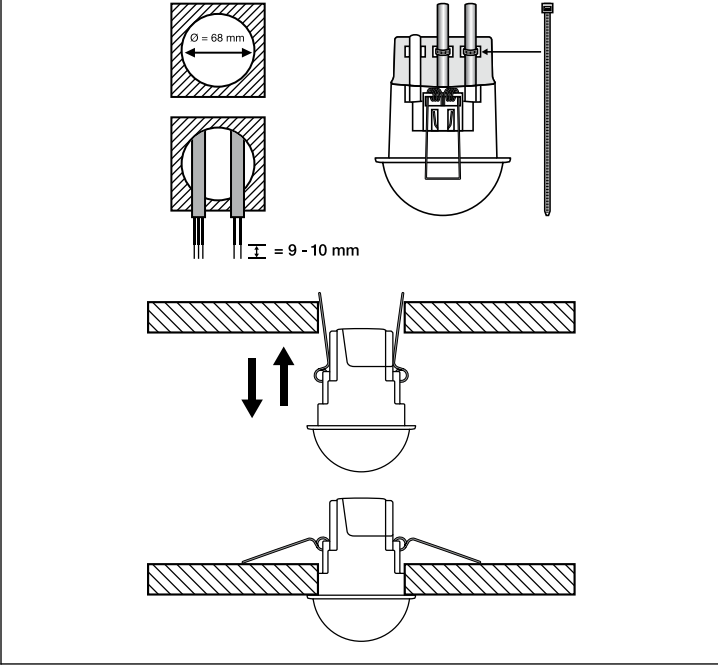

PT INSTRUÇÕES PARA MONTAGEM

ATENÇÃO! As operações na rede de 230 V devem ser executadas apenas por pessoal técnico autorizado, considerando as normas/disposições nacionais sobre instalações. A montagem e ligação do equipamento deve ser efectuada sem tensão ligada.

- A altura de montagem recomendada é de 3 m. Com uma altura de montagem maior o alcance aumenta, mas a sensibilidade diminui. Um movimento transversal ao detector é ideal para um alcance sensibilidade de detecção maior. No caso do movimento for no sentido do detector (frontal), o seu alcance e sensibilidade de detecção, diminuem.
- A colocação do detector deve ter em conta as condições e requisitos de espaço (v. figuras):

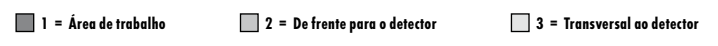

Consoante o tipo, conectar o detector de acordo com esquema de ligações (v. verso):

RU ИНСТРУКЦИЯ ПО МОНТАЖУ

ВНИМАНИЕ! Работы в сети 230 В должны осуществляться исключительно уполномоченным специалистом с учетом общепринятых местных предписаний и норм относительно установки. Перед монтажом продукта необходимо отключить сетевое напряжение.

- Рекомендованная монтажная высота составляет 3 м. С увеличением монтажной высоты дальность действия растёт, но ухудшается чувствительность. Сенсор лучше всего распознает движение поперек датчика. Если объект приближается к датчику по прямой с лицевой стороны (фронтально), сенсору сложнее воспринять движение, и дальность действия существенно снижается.
- Размещение датчика должно соответствовать местным условиям и требованиям (см. рисунки):

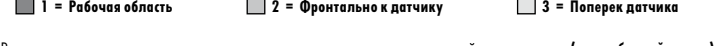

В зависимости от типа датчика подключите его в соответствии со схемой подключения (см. на обратной стороне):

PD-C360i/8, PD-C360i/8 MIC

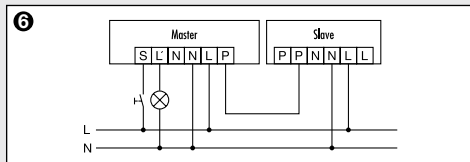
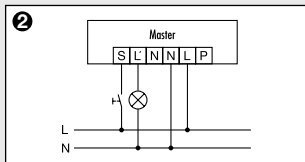
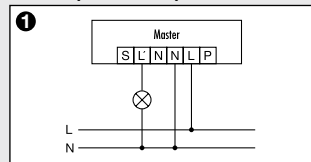

PD-C360i/8plus, PD-C360i/24plus

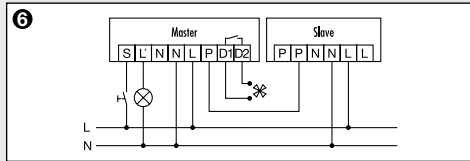
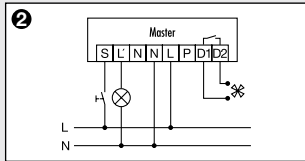
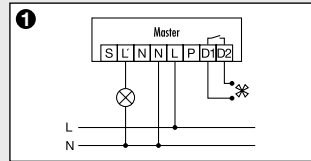

PD-C360i/8 DC24Vplus, PD-C360i/24 DC24Vplus

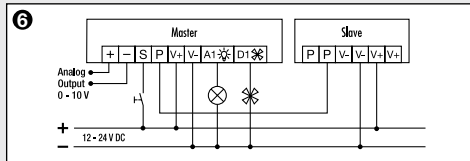
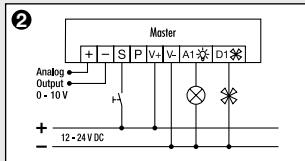
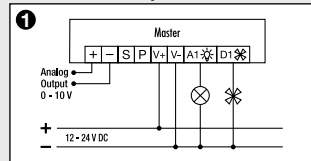

PD-C360i/8 DIM, PD-C360i/24 DIM

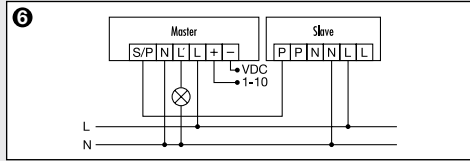
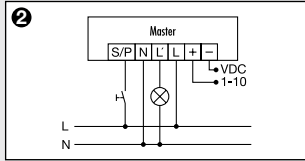
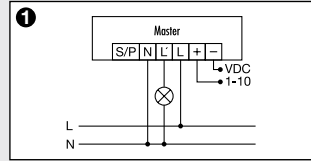

PD-C360i/8 DIMplus, PD-C360i/24 DIMplus, PD-C360i/24 DIMplus WH

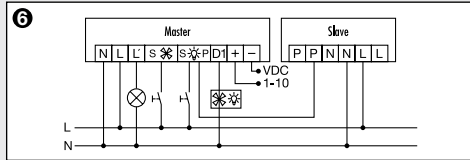
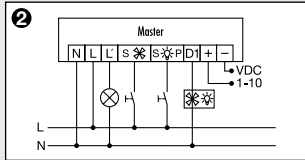
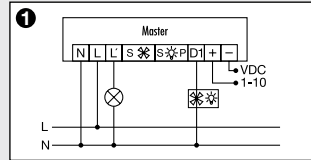

PD-C360i/24 DRY

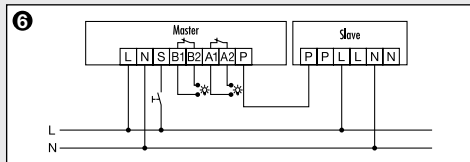
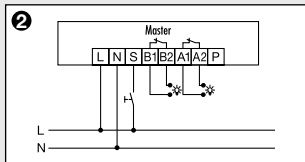
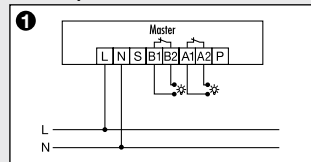

PD-C360i/24 DRY + ILR-230V

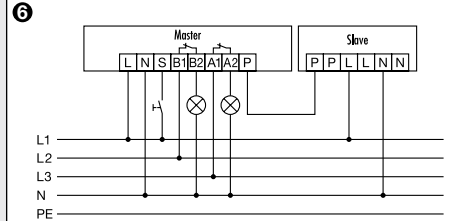
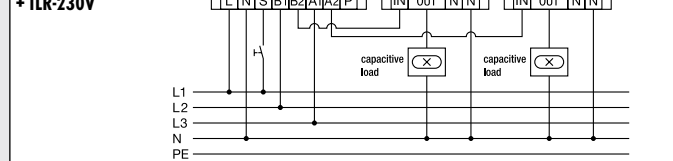

PD-C360i/8 Dali
PD-C360i/24 Dali
PD-C360i/8 DUO DALI
PD-C360i/24 DUO DALI

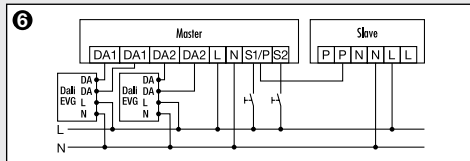
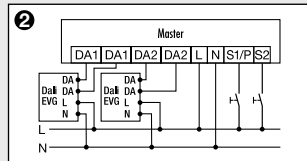
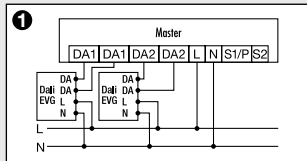

PD-C360i/8 KNX
PD-C360i/24 KNX
PD-C360i/24 KNX ECO
PD-C360i/8 KNX UP
PD-C360i/24 KNX UP
PD-C360i/24 KNX ECO UP
PD-ATMO 360i/8 A KNX
PD-ATMO 360i/8 T KNX

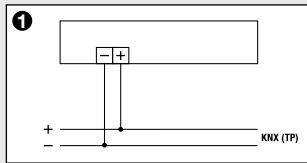

PD-ATMO 360i/8 0 KNX

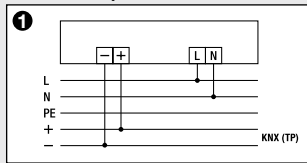

PD-CE360i/8..., PD-CE360i/24...

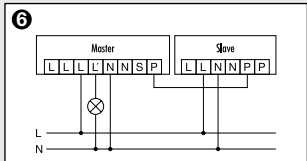
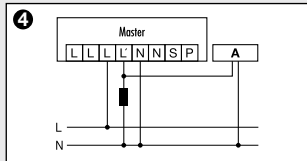
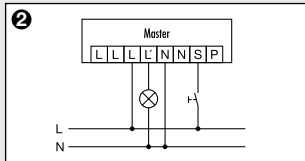
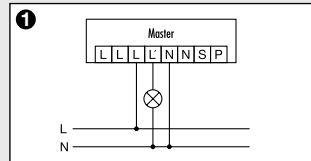

PD-CE360i/8 DIM, PD-CE360i/24 DIM

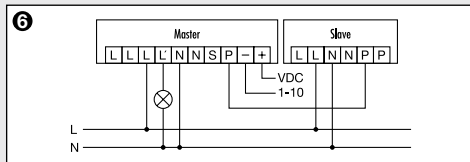
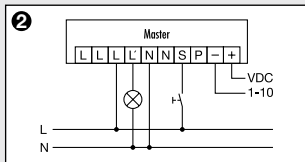
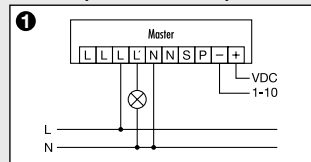

MD-C360i/8, MD-C360i/8 MIC, MD-C360i/24

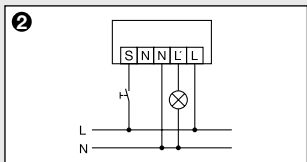
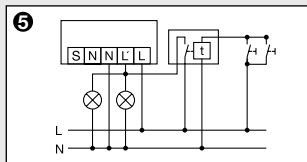
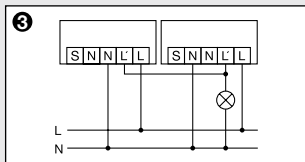
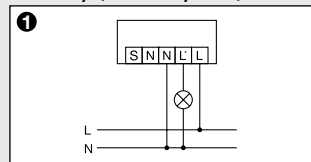

MD-CE360i/8..., MD-CE360i/24...

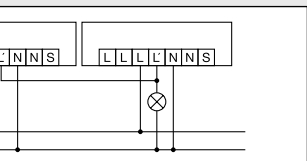
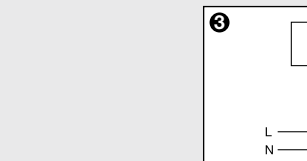
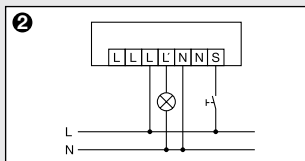
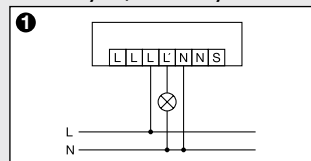

DE • ERKLÄRUNG SCHALTPLÄNE

- 1 Standardbetrieb
- 2 Standardbetrieb mit zusätzlicher Ansteuerung über Taster
- 3 Parallelschaltung von max. 8 Bewegungsmeldern. Parallelschaltung von Präsenzmeldern ist nicht zulässig
- 4 Bei Schaltung von Induktivitäten (z.B. Relais, Schütze, Vorschaltgeräte) kann der Einsatz eines RC-Filters (A) erforderlich sein
- 5 Parallelschaltung mit Treppenlichtautomat
- 6 Master-Slave-Schaltung für Präsenzmelder: Es können max. 10 Slavegeräte an ein Mastergerät angeschlossen werden

GB • EXPLANATION OF CIRCUIT DIAGRAMS

- 1 Standard operation
- 2 Standard operation with additional control by means of a button
- 3 Parallel connection of max. 8 motion detectors. Parallel connection of two or more presence detectors is not possible
- 4 When connecting inductors (e.g. relays, contactors, ballasts) the use of a filter (A) may be necessary
- 5 Parallel connection with automatic stairwell light
- 6 Master/slave connection for presence detectors: a maximum of 10 slave devices can be connected to the master device

FR • LEGENDE DES SCHEMAS ELECTRIQUES

- 1 Installation standard
- 2 Installation standard + bouton
- 3 Montage en parallèle de 8 détecteurs de mouvement max. Les détecteurs de présence ne doivent en aucun cas être branchés en parallèle
- 4 Le branchement d'inductances (par ex. relais, contacteur, ballast) peut nécessiter l'insertion d'un circuit RC (A)
- 5 Montage en parallèle avec minuterie d'escalier
- 6 Raccordement maître/esclave de détecteurs de présence : un appareil maître peut être relié à 10 esclaves maximum

NL • TOELICHTING BIJ SCHAKELSCHEMA'S

- 1 Standaardschema
- 2 Standaardschema met extra aansturing via drukknop
- 3 Parallelschakeling van max. 8 bewegingsmelders. Parallelschakeling van aanwezigheidsmelders is niet toegestaan
- 4 Bij schakeling van inductoren (bijv. relais, magneetschakelaars, voorschakelapparatuur) kan een ontstoringcondensator (A) nodig zijn
- 5 Parallelschakeling met trappenuisautomat
- 6 Master-slave-schakeling van aanwezigheidsmelders: Er kunnen max. 10 slave-apparaten op een master-apparaat worden aangesloten

DK • FORKLARING TIL LEDNINGSDIAGRAMMER

- 1 Standarddrift
- 2 Standarddrift med ekstra styring med aftrydere
- 3 Parallelkobling af maksimalt 8 bevægelsesensensorer. Parallelkobling af tilstedeværelsessensorer er ikke tilladt
- 4 Ved kobling med induktive enheder (f. eks. relæer, kontaktorer, forkoblingsenheder) kan det være hensigtsmæssigt at anvende en støjdæmper (A)
- 5 Parallelkobling med trappelysautomat
- 6 Master-slave-kobling af tilstedeværelsessensorer: Der kan maks. tilsluttes 10 slaveenheder til en masterenhed

SE • FÖRKLARING TILL KOPPLINGSSCHEMANA

- 1 Standarddrift
- 2 Standarddrift med extra aktivering via en knapp
- 3 Paralleldrif med max. 8 rörelsedetektorer. Paralleldrif med närvarodetektorer är ej tillåtet
- 4 Vid till-/frånkoppling med induktivlast (t.ex. med relä, kontaktör eller förkopplingsdon) kan en släckkrets (A) krävas
- 5 Parallellkoppling med automatisk trappströmbrytare
- 6 Master-slavdrift för närvarodetektorer: Högst 10 slavenheter kan anslutas till varje masterenhet

FI • KYTKENTÄKAAVIOIDEN SELITYS

- 1 Vakiokäyttö
- 2 Vakiokäyttö ja lisäohjaus tuntuolimmella
- 3 Kork. 8 liikeilmaisimen rinnankytkentä. Läsnaololmaisinten rinnankytkentä ei ole sallittua
- 4 Induktiiviteettaja (esim. releet, kontaktorit, kytkentälaitteet) kytkettäessä voi sammutuspiiriin (A) käyttö olla tarpeen
- 5 Rinnankytkentä porrassvalaistusautomaatin kanssa
- 6 Läsnaololmaisimen Master-Slave-kytkentä: Korkeintaan 10 Slave-laitetta voidaan liittää yhteen Master-laitteeseen

NO • FORKLARING KOPLINGSSKJEMAER

- 1 Standarddrift
- 2 Standarddrift med ekstra regulering ved hjelp av kontakt
- 3 Parallellkopling av maks. åtte bevegelsesdetektorer. Parallellkopling av tilstedeværelsesdetektorer er ikke tillatt
- 4 Ved omkopling med induktivitet (for eksempel relé, jording, forkoplinger) kan det være nødvendig med en slukkekrets (A)
- 5 Parallellkopling med automatisk trappelysning
- 6 Master/slave-kopling for tilstedeværelsesdetektorer: Det kan koples maks. ti slavedetektorer til en masterdetektor

IT • DESCRIZIONE DELLO SCHEMA ELETTRICO

- 1 Installazione standard
- 2 Installazione standard con comando supplementare mediante tasto
- 3 Collegamento in parallelo fino a un massimo di 8 rilevatori di movimento. Non è possibile un collegamento in parallelo di rilevatori di presenza
- 4 In caso di collegamento di induttanze (per es. relè, contattori, regolatori di corrente, ecc.) può essere necessario impiegare un dispositivo di soppressione dei disturbi (A)
- 5 Collegamento in parallelo tramite temporizzatore luce scale
- 6 Commutazione master-slave per rilevatori di presenza: ad ogni master possono essere collegati max. 10 apparecchi slave

ES • EXPLICACIÓN DE ESQUEMAS DE CONEXIONES

- 1 Funcionamiento estándar
- 2 Funcionamiento estándar con accionamiento adicional mediante palpador
- 3 Conexión en paralelo de máx. 8 detectores de movimiento. No se permite la conexión en paralelo de detectores de presencia
- 4 Cuando se conectan inductancias (p.ej. relés, protecciones, balastos) puede ser necesario utilizar un fusible (A)
- 5 Conexión en paralelo con automatismo luminoso de escalera
- 6 Conexión maestro-esclavo para detectores de presencia: Es posible conectar un máximo de 10 esclavos a un equipo maestro

PT • EXPLICAÇÃO ESQUEMAS ELÉTRICOS

- 1 Modo de operação normal
- 2 Modo de operação normal com controlo adicional por meio de um botão de pressão
- 3 Ligação em paralelo de no máx. 8 detectores de movimento. Uma ligação em paralelo de detectores de presença não é admissível
- 4 No caso de ligação de indutâncias (p. ex. relés, disjuntores, balastos), pode ser necessária a utilização de um elemento de supressão (A)
- 5 Ligação em paralelo com automático de escada
- 6 Ligação master-slave para detectores de presença: pode ser conectado um máx. de 10 equipamentos slave a um equipamento master

RU • ПОЯСНЕНИЕ СХЕМЫ ПОДКЛЮЧЕНИЯ

- 1 Стандартная эксплуатация
- 2 Стандартная эксплуатация с дополнительным управлением с помощью кнопочного выключателя
- 3 Параллельное подключение макс. 8 датчиков движения. Параллельное подключение датчиков присутствия невозможно
- 4 При включении и выключении индуктивных нагрузок (например, реле, контакторов, подключенных на входе устройств) может потребоваться установка RC-фильтра (A)
- 5 Параллельное подключение лестничного автомата
- 6 Переключение «ведущих» («Master») и «ведомых» приборов («Slave») для датчика присутствия: к одному «ведущему» прибору («Master») можно подключить максимум 10 «ведомых» приборов («Slave»)

ESYLUX

ESYLUX GmbH
An der Strusbek 40, 22926 Ahrensburg/Germany
Internet: www.esylux.com
e-mail: info@esylux.com



MA00249703 • ALK 08/14