

Uninterruptible Power Supply (UPS/220-240V model)

BU□002SWG

An ideal UPS for building into industrial equipment

- Standard-feature remote ON/OFF, terminal block output & schuko plug and CE Marking
- Standard-feature automatic shutdown software compatible with the latest virtual operating systems.
- Ideal for systems that require stability (standard-feature bypass function).
- Cold start
- Easy maintainance (LED display, hot swap battery replace)



Refer to *Safety Precautions* on page 10.

Ordering Information

Note: For details on normal stock models, contact your nearest OMRON representative.

Main body

Input voltage	Output voltage	Output current/capacity	Model
220/230/240 VAC	220/230/240 VAC	1,000 VA/700 W	BU1002SWG
		3,000 VA/2,100 W	BU3002SWG

Related products

Description	BU1002SWG	BU3002SWG
Replacement battery pack	BP100XSG	BP150XSG
Mounting bracket	BUP100SG	BUP300SG
SNMP/Web card	SC20G2G	
Contact I/O card	SC08G *	

* The standard UPS connection signal is NPN. To use a PNP connection, replace with "SC08G" included in the package.

Ratings, Characteristics, and Functions

		BU1002SWG	BU3002SWG
Method	Operation method	Full-time inverter supply method	
	Connectable devices	PC, display, and peripherals	
Input	Rated input voltage	220/230/240 VAC	
	Input voltage range	AC 185±4 to 276±4 V (with 85% or less connection load) AC 210±4 to 276±4 V (with 85% or more connection load)	
	Frequency	50/60 Hz ± 4 Hz	
	Maximum current	5.8 A	16 A
	Phase	Single-phase, two-wire	
	Input plug shape	Schuko CEE 7/7 P	Schuko CEE 7/7 P
	Input protection	Reset-type overcurrent protection device	
	Input protection capacity	10 A	20 A
Output	Allowable connection capacity *1	1000 VA/700 W	3000 VA/2100 W
	Voltage (effective value) *2	220 V mode AC 220 V ± 3% 230 V mode AC 230 V ± 3% 240 V mode AC 240 V ± 3%	
	Peak voltage value (In Commercial Power Mode)	220 V mode: AC 310 V ± 6% 230 V mode: AC 324 V ± 6% 240 V mode: AC 338 V ± 6%	
	Peak voltage value (In Battery Mode)	220 V mode: AC 310 V +6%/-10% 230 V mode: AC 324 V +6%/-10% 240 V mode: AC 338 V +6%/-12%	
	Frequency	50/60 Hz ± 1 Hz	
	Phase	Single-phase, two-wire	
	Output waveform	Sine wave	
	Waveform distortion rate (Rectified load, at rated output)	220V mode: 10% max. 230V mode: 10% max. 240V mode: 12% max.	
	Number of output receptacles	IEC60320 C13: 3 pcs. Terminal block: 2 lines	IEC60320 C19: 1 pcs. C13: 5 pcs. Terminal block: 2 lines
	Power failure switching time	Uninterrupted	
	Commercial direct shipment (switching time)	4 m sec. max.	
Backup time *3	Minimum 5 minutes		
Battery	Type	Compact sealed lead battery	
	Sealed lead battery life expectancy	4 to 5 years (long operating life) *At ambient temperature of 20°C	
	Battery capacity (V/Ah) (x Quantity)	12V DC/ 7.2 Ah (x 3)	12V DC/ 8 Ah (x 6)
	Charging time	8 hours *4	
Environment	Operating ambient temperature	0 to 40°C (during operation)/ -15 to 50°C (during storage)	
	Operating ambient humidity	25 to 85% RH (during use)/10 to 90% RH (during storage)	
Dimensions (W x H x D mm)		145 x 395 x 224 (±1) mm *5	213 x 537 x 432 (±1) mm *6
Weight of unit		Approx. 15.5 kg	Approx. 35 kg
Internal power consumption (max.)		50 W (100 W max.)	55 W (155 W max.) *7
Noise regulation (compliance standard)		VCCI Class A	
Safety standards / RoHS directive compliance		CE / RoHS compliance	
Noise		50 dB max.	55 dB max.
Serial communication (RS-232C) (Interface)		D-Sub 9 pin	
Serial communication (USB) (Interface)		B type *8	
Contact signal (Interface)		D-Sub 9 pin *9	

*1. Make sure that both the VA value and the W value of the load capacity connected to the UPS are within the range specified here.

*2. Check the operation beforehand if the unit is used in any mode other than "220V AC mode". In some cases, the maximum voltage of output in Battery Mode may be lower than the maximum voltage in usual operation (commercial power supply).

*3. The backup times shown here are for when rated load is connected, at 20°C, and for initial characteristics.

*4. When an additional battery unit is connected, the charging time is 24 hours.

*5. The height includes the 13 mm height of the rubber feet.

*6. The height includes the 56 mm height of the casters.

*7. 170 W max when and additional battery unit is connected.

*8. USB or RS-232C either is available. (unusable at the same time)

*9. The standard UPS connection signal is NPN. To use a PNP connection, replace with "SC08G" included in the package.

Connections

Block Diagrams

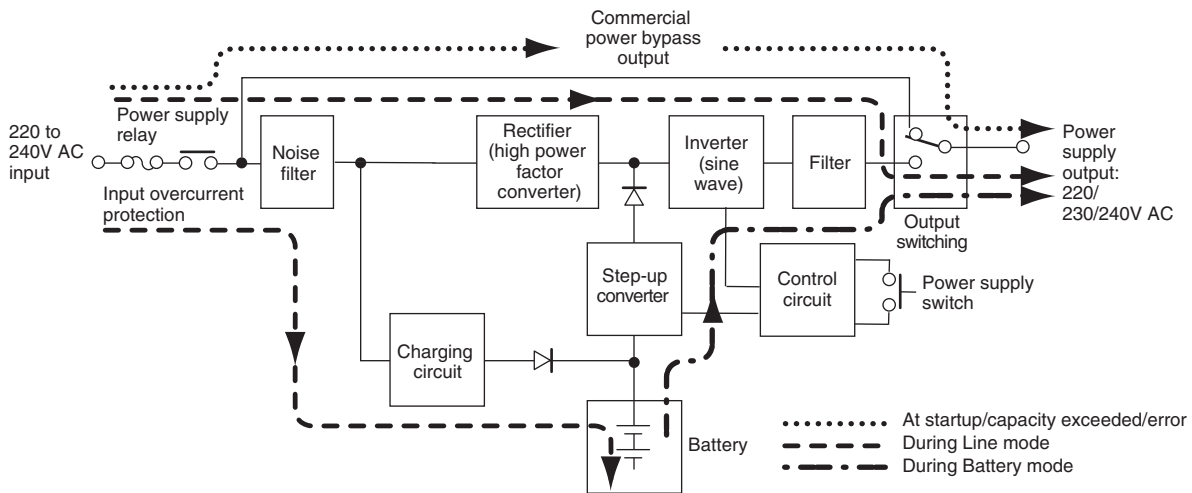

I/O signal functions

The standard UPS connection signal is NPN. To use a PNP connection, replace with "SC08G" included in the package.

Type of output signals

Signal	Description
Backup signal output (BU)	Stays ON during backup operation at a power failure.
Low battery level signal output (BL)	Goes ON when the battery becomes Low level during backup operation at a power failure.
Trouble signal output (TR)	Goes ON when an internal failure of the UPS occurs.
Battery replacement signal output (WB)	Goes ON when the test determines that battery replacement is necessary due to deterioration or when the battery life counter reaches the replacement period. (The life counter operates while input power is being supplied.)

Type of input signals

Signal	Description
Input of the UPS stop signal (BS)	When the BS signal is ON (High), the output of the UPS is stopped after the time period specified in advance has elapsed. The time period can be set using the LCD. *
Remote ON/OFF signal	Remote ON/OFF signals can be used to start and stop the UPS, by using either an externally connected contact or the ON/OFF status of the open collector circuit.

* BS signal delay time

It is possible to set the period of time from when a BS signal is received until the output of the UPS is stopped.

Jumper settings (SC08G)

The jumper settings on the SC08G board are used to invert output signal.

Use the jumper setting on the SC08G board to set the input voltage range 12 V to 24 V for the High state of the backup power stop signal. (BS signal)

Use the jumper setting on the SC08G board to set how an uninterruptible power supply (UPS) is turned on/off by a remote ON/OFF signal.

Contact signal I/O connector (female DSUB9P)

Pin assignments	Pin number	Item (main unit)	Signal name (SC08G)
<p>Front view Screw size: inch screw #4-40 UNC</p>	1	Battery LOW signal output (BL)	Backup signal output-1 (BU-1)
	2	Trouble signal output (TR)	Backup signal output-2 (BU-2)
	3	Backup stop signal input (BS)	Battery LOW signal output-1 (BL-1)
	4	NC	Battery LOW signal output-2 (BL-2)
	5	COMMON (COM)	Trouble signal output (TR)
	6	Remote ON/OFF input (-)	TR signal and WB signal COMMON (TR/WB-COM)
	7	Remote ON/OFF input (+)	Deteriorated battery signal output (WB)
	8	Backup signal output (BU)	Backup stop signal input + (BS+)
	9	Deteriorated battery signal output (WB)	Backup stop signal input - (BS-)

Dedicated connector for remote ON/OFF (SC08G)

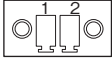
Pin assignments	Pin number	Signal name
 <p>Front view Screw size: inch screw #4-40 UNC</p>	1	Remote ON/OFF input (+)
	2	Remote ON/OFF input (-)

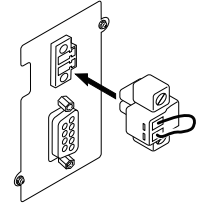

Contact signal ratings (main unit)

Signal	Description
Signal output (BL, TR, BU, WB)	<ul style="list-style-type: none"> Photo coupler ratings Applicable voltage: 35 VDC or less Maximum current: 50 mA
Remote ON/OFF	<ul style="list-style-type: none"> Voltage between terminals: 5 VDC Current when closed: 10 mA max.
UPS Stop Signal input (BS)	<ul style="list-style-type: none"> Input voltage: HIGH (ON) 5 to 24 VDC LOW (OFF) 0.7 VDC or less

Contact signal ratings (SC08G)

Signal	Description
Signal output (<u>BU</u> , BU, <u>BL</u> , BL, <u>TR</u> , TR, <u>WB</u> , WB)	<ul style="list-style-type: none"> Relay rating Applicable voltage: 30 VDC or less Maximum current: 2 A (resistive load) 1 A (inductive load)
Remote ON/OFF	<ul style="list-style-type: none"> Voltage between terminals: 5 VDC Current when closed: 10 mA max.
UPS Stop Signal input (BS, BS)	<ul style="list-style-type: none"> Input voltage: HIGH (ON) 8 to 24 VDC (when set to 24 V) 5 to 12 VDC (when set to 24 V) LOW (OFF) 0.7 VDC or less Sink current when High signal is input: 20 mA max.

Signal I/O circuit (main unit)

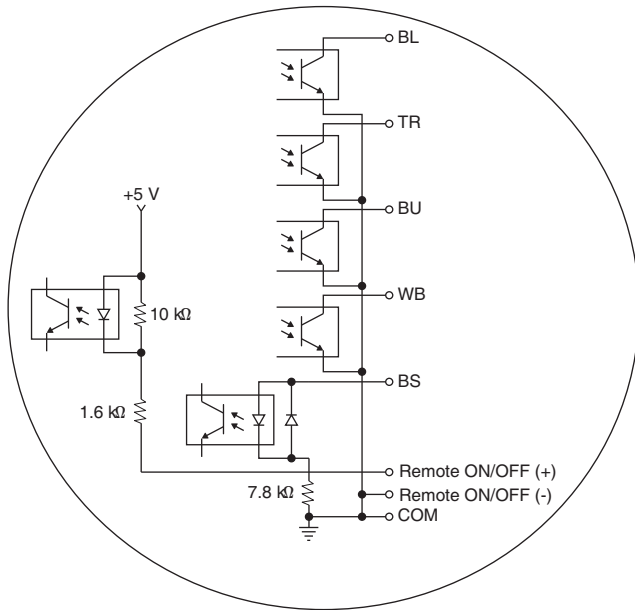

Signal I/O circuit (SC08G)

Output signal circuit

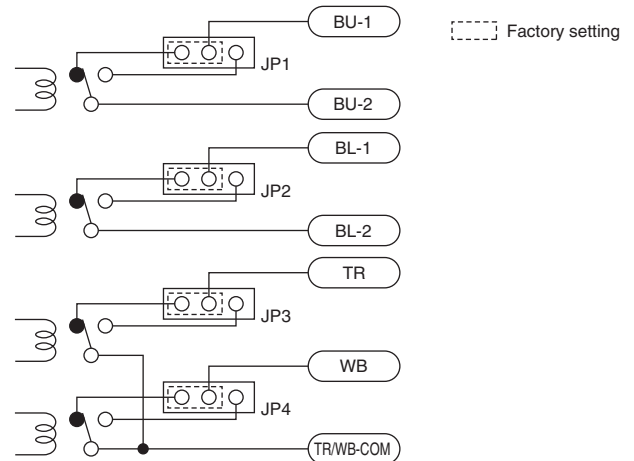

Input signal circuit

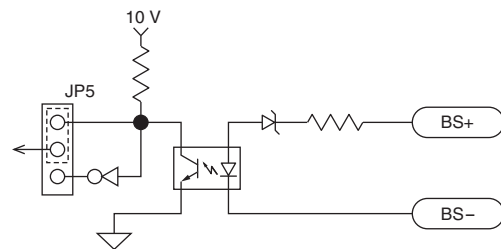

Remote ON/OFF signal circuit

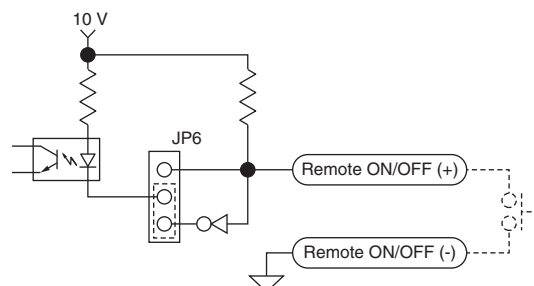

Example of the use of the Contact Signal circuit (main unit)

Example of BU signal output circuit and the connected circuit

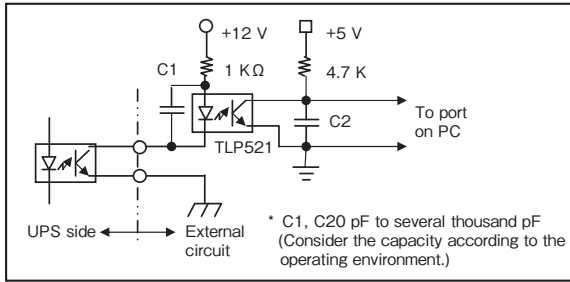

Example of BS signal input circuit and the connected circuit

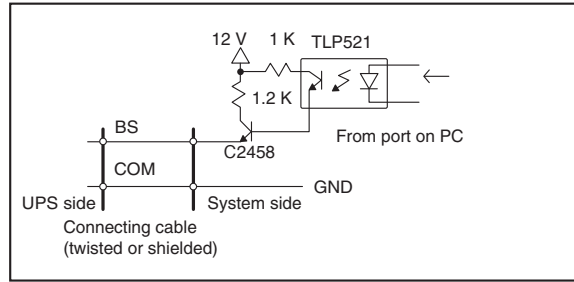

Remote ON/OFF circuit

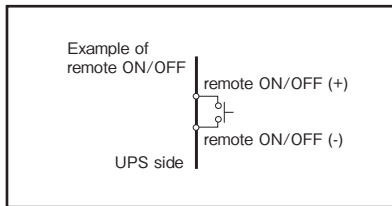

Example of the use of the Contact Signal circuit (SC08G)

Example of BU signal output circuit and the connected circuit

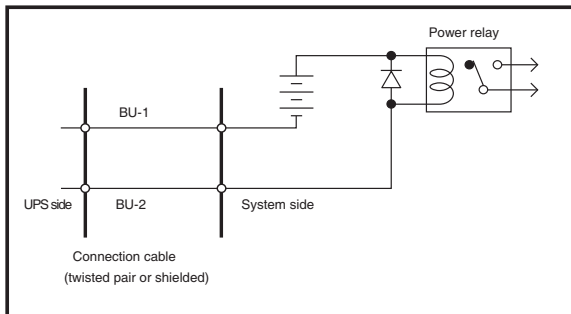

Example of BS signal input circuit and the connected circuit

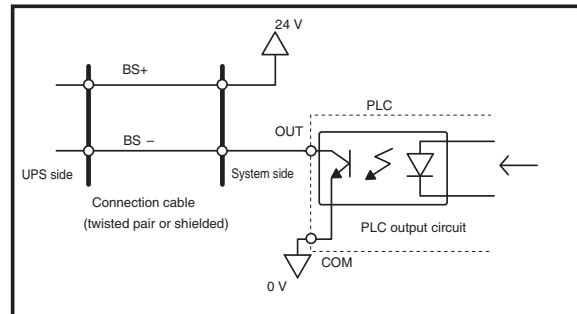

Remote ON/OFF signal circuit

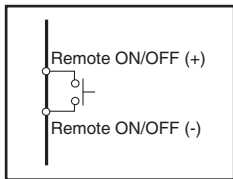

BU□002SWG

Nomenclature

Front view

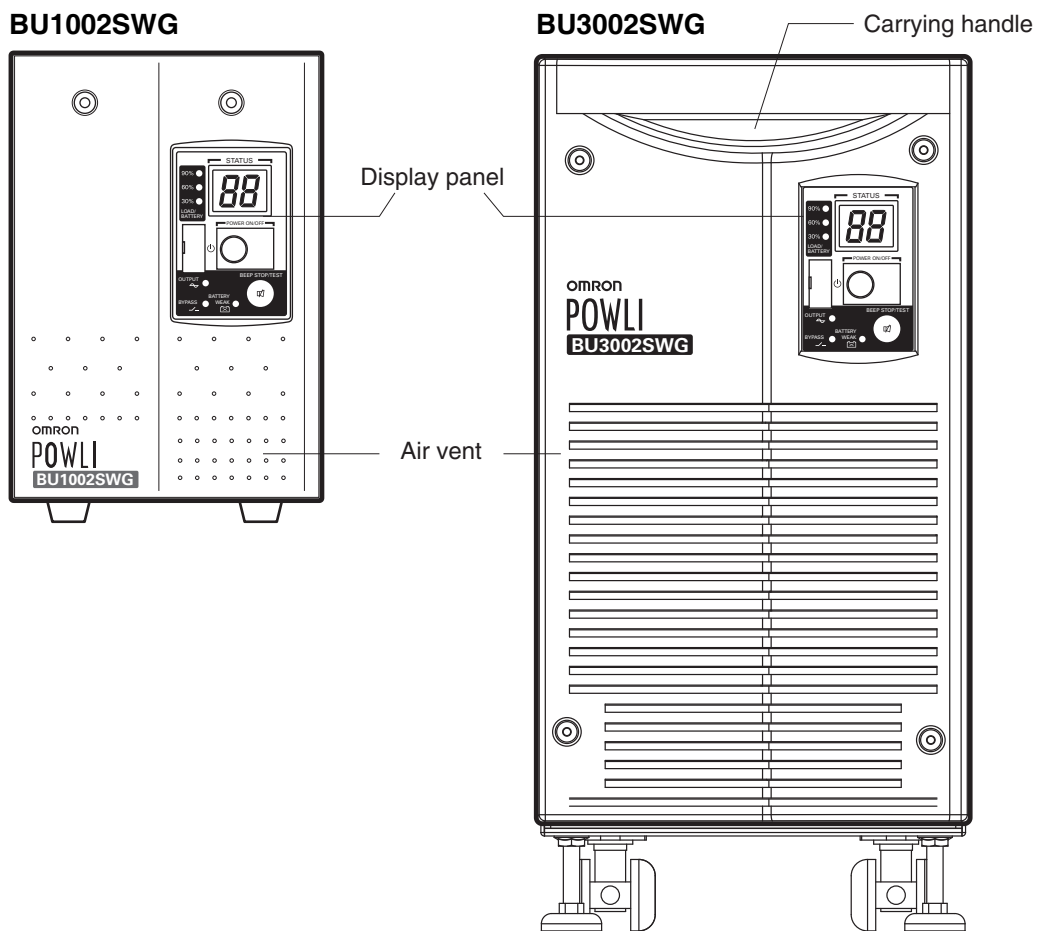

Enlarged view of the operation panel

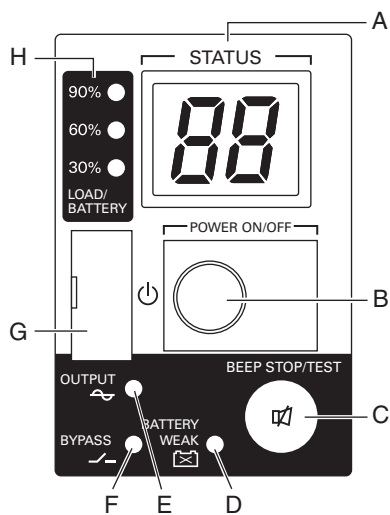

A.	Status indicator digital display
B.	Power switch
C.	Beep stop/test switch
D.	Battery replacement lamp
E.	Power supply output lamp
F.	Bypass operation lamp (The input power supply is output as is.)
G.	Setting switch cover
H.	Connection capacity/battery level meter

Rear view
BU1002SWG

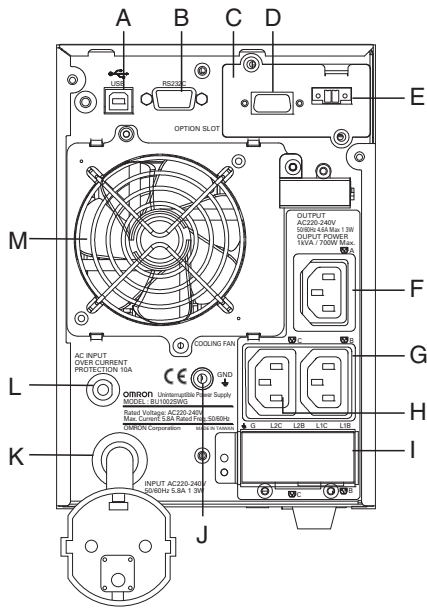

A.	USB connector
B.	RS-232C connector
C.	Contact signal card
D.	Contact signal connector
E.	Remote ON/OFF connector
F.	Power supply output receptacle A (IEC60320 C13)
G.	Power supply output receptacle B (IEC60320 C13)
H.	Power supply output receptacle C (IEC60320 C13)
I.	Terminal block for output
J.	Grounding terminal
K.	AC input cable
L.	AC input overcurrent protection
M.	Cooling fan

BU3002SWG

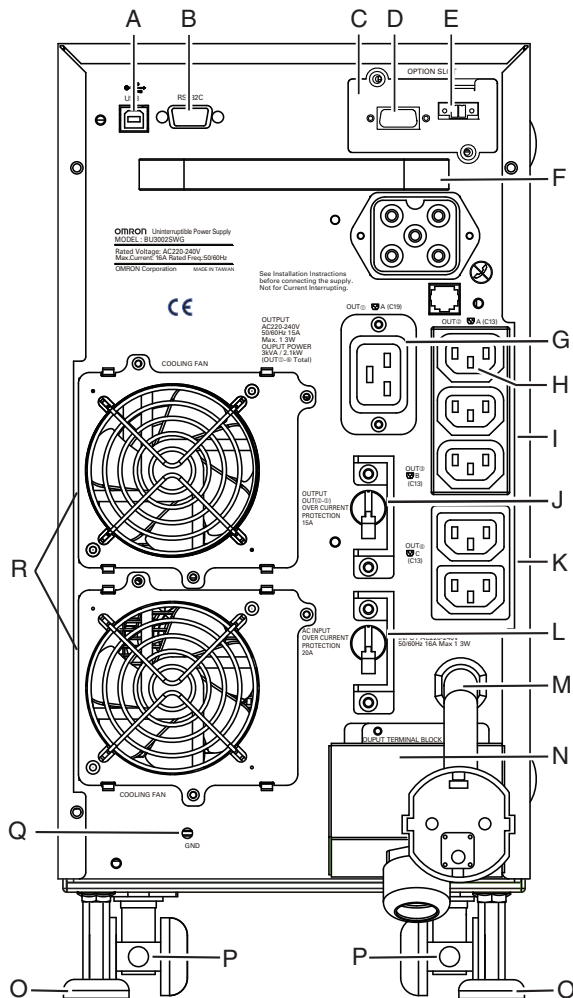

A.	USB connector
B.	RS-232C connector
C.	Contact signal card
D.	Contact signal connector
E.	Remote ON/OFF connector
F.	Handle
G.	Power supply output receptacle A (IEC60320 C19)
H.	Power supply output receptacle A (IEC60320 C13)
I.	Power supply output receptacle B (IEC60320 C13)
J.	Overcurrent protection switch for output 15 A
K.	Power supply output receptacle C (IEC60320 C13)
L.	AC input overcurrent protection switch 20 A
M.	AC input cable
N.	Terminal block for output
O.	Fixed stand
P.	Castors
Q.	Grounding terminal
R.	Cooling fan

Engineering Data

The backup time varies depending on the capacity of connected devices.
 After calculating the total capacity of connected devices, refer to the graph of the backup time to obtain an estimation of the initial value of the backup time. (This is also applied to checking the battery.)

- Convert the total capacity (power consumption) of the connected devices to watts (W).
 For the indication of connected devices, check your computer and the rear of the display.
 The indicator can show values in three different ways: volt-amperes (VA), amperes (A), and watts (W).

Example 1) 220 VAC, 50/60 Hz, 185 W
 Example 2) 220 VAC, 50/60 Hz, 1.8 A
 Example 3) 220 VAC, 50/60 Hz, 190 VA

Indication	Value
VA	× power factor = W
A	× power factor × 220 = W

For devices that use the VA or A indication, convert the capacity into W. Multiply the value indicated on devices by the value in the right table for conversion.

(When the power factor is unknown, enter "1". The power factor usually ranges between 0.6 and 1.)

- Add the values converted into W to obtain the total capacity of the connected devices.
- Calculate the initial value of the backup time for the total capacity of the connected devices from the graph below.
 - Graph of backup time (graph of initial values for products that have not been used)
 - The smaller the capacity of connected devices becomes, the longer the backup time becomes.

Estimated backup time

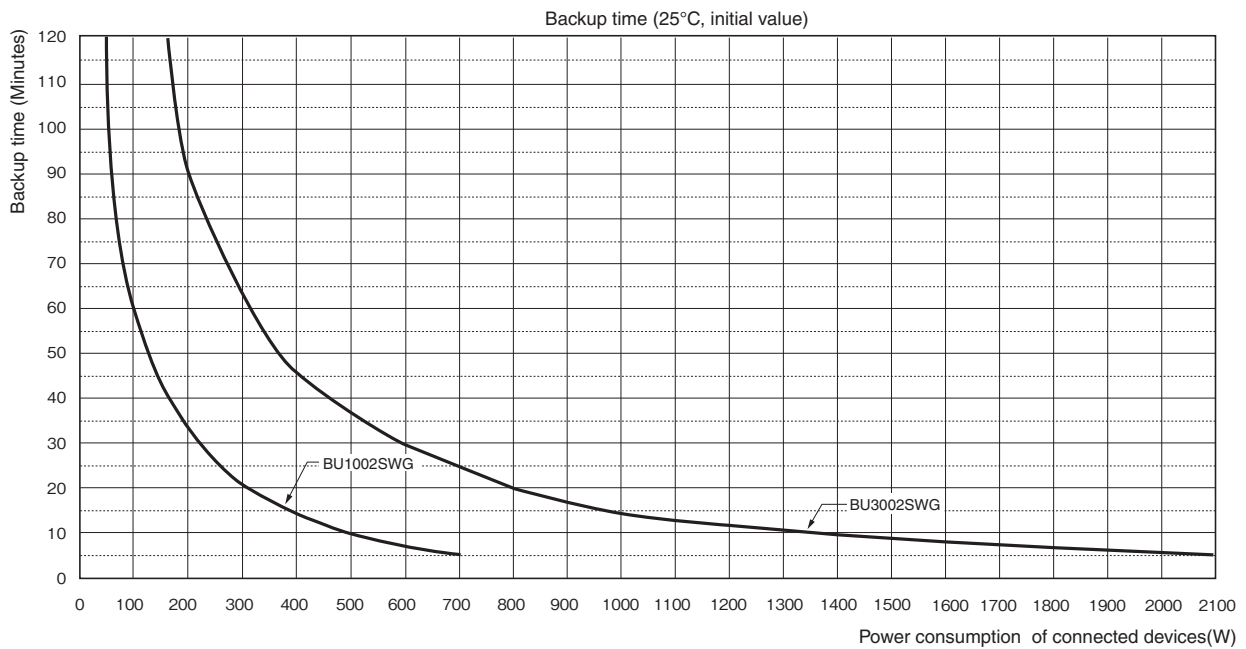

Backup time table

(Time unit: minutes)

BU1002SWG

Connection capacity (W)	20	50	100	200	300	400	500	700	1000	1400
Backup time (Minutes)	180	120	60	35	20	15	10	5	-	-

BU3002SWG

Connection capacity (W)	200	400	600	800	1000	1200	1400	1600	1800	2000	2100
Backup time (Minutes)	9.2	4.6	3.0	2.0	1.5	1.2	1.0	0.8	0.7	0.55	0.5

* These backup times are for reference only. Times may vary according to battery life and external environmental conditions (temperature, etc.).

Dimensions

((unit : mm / Tolerance : ±1mm))

BU1002SWG

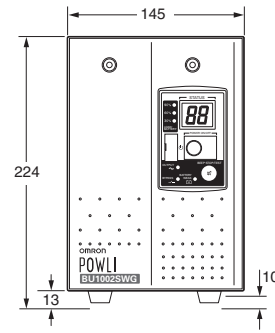
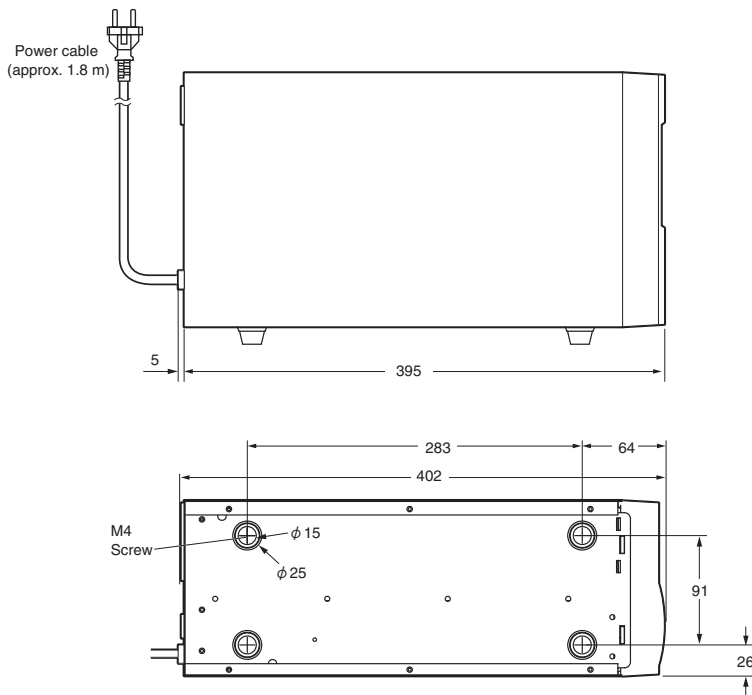

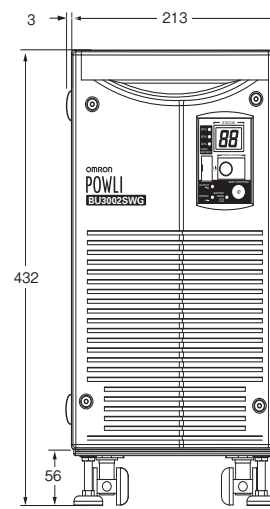
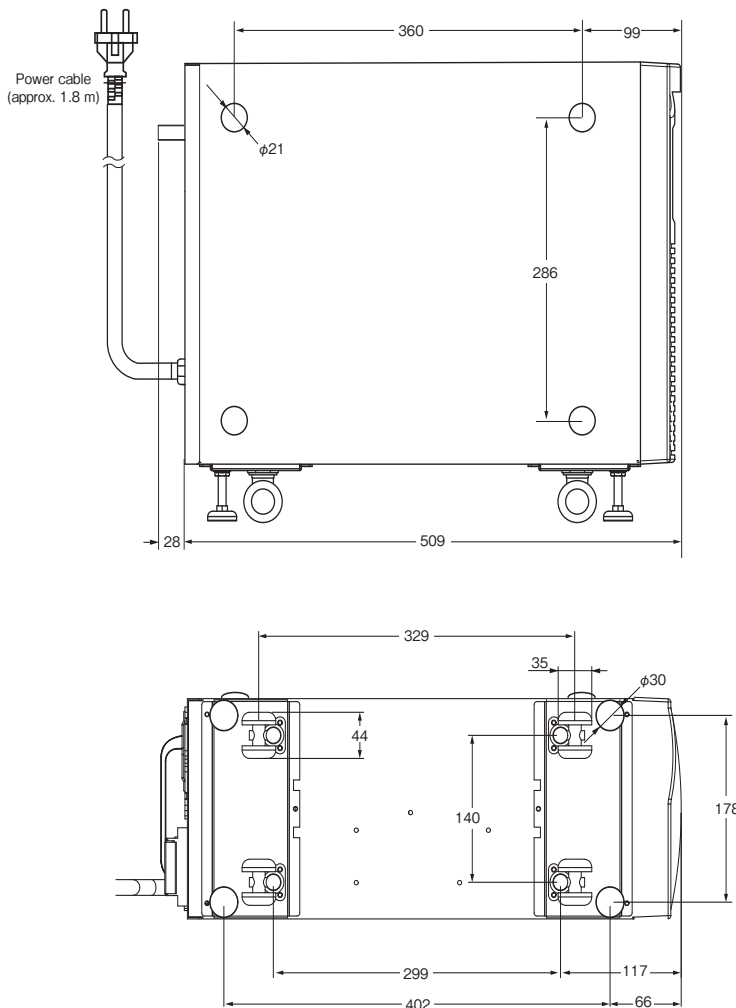

BU3002SWG









Safety Precautions

Warning Indications

 Warning	Indicates a potentially hazardous situation that, if not avoided, could result in serious injury or death. Additionally there may be significant property damage.
 Caution	Indicates a potentially hazardous situation that, if not avoided, could result in minor or moderate injury or property damage.

Meaning of Product Safety Symbols

	General inhibition Notice prohibiting an unspecified general action.
	General instruction Notice instructing an unspecified general action.
	Be sure to connect an earth cable. For a device equipped with a safe earth terminal, indicates instructions to the user for the sure connection of an earth cable.
	Do-not-disassemble prohibition Notice prohibiting disassembly because disassembling the device may cause such an accident as an electric shock.
	Prohibition of use in locations subject to water such as a bathroom and shower room Notice prohibiting installation of the device in locations subject to water, because if a device not made water-proof is used in such locations, injury may occur due to an electric leak.
	Do-not-touch prohibition Notice prohibiting disassembly because disassembling the device may cause such an accident as an electric shock.

 **Warning**

Do not use this unit when very high reliability and safety are required as listed below. This unit is designed and manufactured for use with FA, OA equipment such as personal computers. 

- Medical equipment or system that may cause death directly.
- Applications that directly affect the safety of people (For example, the operation and control of cars and elevators).
- Applications in which a failure of the unit may cause significant damage to the society and public (For example, essential computer systems and main communication equipment.)
- Applications with the same level of importance.

 **Caution**

(for installation and connection)

Two or more people should work together to carry, unpack and install the BU3002SWG. 

- Because the unit is heavy, you may injure yourself or drop the unit, or it may fall over.

Carry the unit considering its weight and balance, and place it on a stable and robust base. 

- Dropping or toppling the unit may cause injury.
- Approximate weight of the unit:
15.5 kg (BU1002SWG)
35 kg (BU3002SWG)
- If you drop the unit, stop using it and have it inspected and repaired. For repair, contact OMRON representatives.

Keep plastic package bags out of reach of children. 

- Children may suffocate if they place their heads into plastic bags.

Make sure to connect the AC input plug of the unit into a wall outlet (commercial power) with rated input voltage (220 to 240V AC). 

- Connecting to a wall outlet (commercial power) of a different rated input voltage may result in fire.
- The unit may fail.

When an abnormality (unusual sound or smell) occurs, turn OFF the unit's power switch and disconnect the AC input plug from the wall outlet. 

Install the unit soon after the AC input plug is disconnected from the wall outlet.

- When performing maintenance on the connected devices, follow the above instructions to ensure safety.

Do not connect devices such as dryers, some solenoid valves, etc. , which have a half-wave rectifier that allows only half-cycle AC power to flow through. 

- Overcurrent may damage the UPS.

Connect the BU1002SWG to a wall outlet (commercial power) with a capacity of 5.8 A or more, and connect the BU3002SWG to a wall outlet (commercial power) with a capacity of 16 A or more. 

- Otherwise, the power cord may be heated.
- When equipment with the maximum output capacity is connected, a maximum current of 5.8 A (BU1002SWG) or 16 A (BU3002SWG) flows.

Provide secure grounding. 

- After checking the plug shape of the wall outlet, directly connect the AC input plug of the unit to it. A failure or leak that occurs when the unit is not properly grounded may result in electric shock.

Do not disassemble, repair, or modify the unit. 

- Doing so may cause an electric shock or a fire.

Do not install the unit in other than specified orientations. 

- Dropping or toppling the unit may cause injury.
- If you install the unit in an orientation other than specified, the unit cannot be protected from a battery fluid leakage.

Do not use the unit where the maximum temperature exceeds 40°C. 

- The battery becomes weak rapidly, which may cause a fire.
- Doing so may cause a failure or malfunction of the unit.

Do not exceed the ranges specified for environmental conditions during use/storage.

Do not install or store the unit in the places listed below.

- Do not store in places where the humidity is lower than 10% or higher than 90%.
- Do not use in places where the humidity is lower than 25% or higher than 85%.
- Do not install/store the unit in closed places such as cabinets with no clearance, places where there is flammable or corrosive gas, places with large amounts of dust, places exposed to direct sunlight, places exposed to shock or vibration, or outdoors.
- Installation or storing the unit in such a place may cause a fire.



Do not block the air vents on the unit. The BU1002SWG has air vents on the front, side and back, while the BU3002SWG has air vents on the front and back.

- Doing so will cause the internal temperature to rise, which may cause the unit to fail and the battery to deteriorate.
- Leave at least 5 cm of space between the vent and the wall.



Do not connect equipment that exceeds the output capacity of the unit. You can use a 220 V plug strip to connect additional devices, but do not connect devices that exceed the current capacity of the plug strip.

- The current protection of the unit may operate, which may stop the output.
- The wiring of the plug strip heats up, which may cause a fire.



Do not connect a standalone transformer such as a voltage transformer or isolating transformer to the output side.

- Overcurrent may damage the UPS.
- There is no problem in connecting a transformer to the input side.



Do not pinch or sharply bend the cable. Do not fold or knot the cable.

- Doing so may cause the cable to be damaged or heated, which may cause an electric shock or a fire.
- If the cable is damaged, stop using the unit and have the cable repaired.

For repair, contact OMRON representatives.



Do not connect devices that cannot be used with commercial power supply.

- When the unit's power switch is turned ON and an error occurs with the connected device, bypass operation is performed and commercial power supply is supplied as is to the connected devices.



All of the included accessories are designed to be used exclusively with the unit. Do not use the accessories with other devices.

- Doing so may compromise the safety of devices.



Do not connect devices with rated voltage of 220 to 240 VAC or higher.

- The rated output voltage of this device is 220 to 240 VAC.
- Overcurrent may damage the connected devices.



- This UPS utilizes voltages that may be hazardous. Do not attempt to disassemble the unit. The unit contains no user serviceable parts. Only factory service personnel may perform repairs.



When in use, make sure the output terminal block cover is attached.

Do not turn ON the power switch when it is detached.

- Voltage is applied to the output terminal block when the power switch is ON, which can result in electric shock.



- Connection to any other type of receptacle other than a two-pole, three-wire grounded receptacle may result in shock hazard as well as violate local electrical codes.



For PLUGGABLE EQUIPMENT, the socket-outlet shall be installed near the equipment and shall be easily accessible.



(for use)

- Do not allow liquids or any foreign object to enter the UPS. DO not place beverages or any other liquid-containing vessels on or near the unit.



Never touch the metal part of the input plug if it is disconnected while the unit is operating.

- Doing so may result in electric shock.
- The leak current of this product itself is less than the value of the safety standard (leak current: 1 mA). However, because connected equipment causes the leak current to increase, you must never touch the metal part of the input plug.
- When the unit is operating, voltage is generated in the metal parts of the input plug via capacitors in the internal circuit, regardless of the elapsed time.



- This unit intended for installation in a controlled environment (temperature controlled, indoor area free of conductive contaminants). Avoid installing the UPS in locations where there is standing or running water, or excessive humidity.



Do not allow the unit to come in contact with water.

- Doing so may cause an electric shock or a fire.
- If the unit becomes wet, stop using it and have it inspected and/or repaired.

For repair, contact OMRON representatives.



- Do not attach a power strip or surge suppressor to the UPS.



When the battery is dead, replace it immediately or stop using the unit.

- Continuing the use of it may cause a fire.



- Do not attach non-computer-related items, such as medical equipment, life-support equipment, microwave ovens, or vacuum cleaners to UPS.



Ambient temperature	Expected life
20°C	4 to 5 years
30°C	2 to 2.5 years

- With the installation of the equipment it should be prevented, that the sum of the leakage current of the UPS and the connected consumer does not exceed 3.5 mA.



*The values in the table are the expected life under standard use conditions and are not guaranteed.

Using a dry cloth, periodically wipe the dust from the AC input plug, power supply output receptacles and output terminal block.

- Accumulated dust may cause a fire.



Do not use the unit in a closed place and do not cover the unit.
 • Doing so may cause abnormal heating or a fire.



If you notice abnormal sound or smell, smoke, or leakage from the inside, immediately turn off the power switch and disconnect the AC input plug from a wall outlet (commercial power).
 • Using the unit under such conditions may cause a fire.
 • If you notice such a condition, stop using the unit and contact OMRON representatives for inspection and repairs.
 • Use the unit under the conditions in which you can immediately disconnect the AC input plug from a wall outlet (commercial power) in the case of an abnormal event.



If fluid leaks from the unit, do not touch the fluid.
 • Doing so may cause blindness or burns.
 • If the fluid contacts your eyes or skin, wash it out with lots of clean water and consult your doctor.



Do not place objects heavier than 25 kg on the unit, and do not drop heavy objects onto the unit.
 • Doing so may cause distortion/damage to the case or a failure of the internal circuit, which may cause a fire.



(for maintenance)

When maintaining the connected equipment, turn OFF the power switch and disconnect the AC input plug.
 • Even if you disconnect the AC input plug while the UPS is operating, the power output of this unit does not stop and power is supplied from the outlet during a power failure.



Do not disassemble, repair, or modify the unit.
 • Doing so may cause an electric shock or a fire.



If fluid leaks from the unit, do not touch the fluid.
 • Doing so may cause blindness or burns.
 • If the fluid contacts your eyes or skin, wash it out with lots of clean water and consult your doctor.



Do not throw the unit into fire.
 • The lead battery in the unit may explode, or leak dilute sulfuric acid.



Do not insert metal objects into the power supply output receptacle or terminal block of the UPS.
 • Doing so may result in electric shock.



Do not insert metal objects into the battery connectors.
 • Doing so may result in electric shock.



(for battery replacement)

Perform replacement on a stable and flat place.
 • Handle the battery carefully so that you do not drop it.
 • Not doing so could cause injury or burns due to liquid (acid) leakage.



Use a specified battery for replacement.
 • Not doing so may cause a fire.
 • Product model:
 BP100XSG: (Replacement battery pack for BU1002SWG)
 BP150XSG: Two required (Replacement battery pack for BU3002SWG)



Do not replace the battery in a place where there is flammable gas.
 • Spark may occur when connecting the battery, which may cause an explosion or fire.



If fluid (dilute sulfuric acid) leaks from the battery, do not touch the fluid.
 • Doing so may cause blindness or burns.
 • If it contacts your eyes or skin, wash it out with lots of clean water and consult your doctor.



Do not disassemble or modify the battery.
 • Doing so could cause dilute sulfuric acid leak, which could cause blindness and burns.



Do not drop the battery and do not expose it to strong impact.
 • Dilute sulfuric acid may leak.



Do not short the battery with metal objects.
 • Doing so could cause an electric shock, fire or burn.
 • Some electrical energy still remains inside the spent battery.



Do not put the battery into fire and do not break it.
 • The battery may explode or leak dilute sulfuric acid.



Do not use a new battery and an old battery at the same time.
 • Dilute sulfuric acid may leak.



• A battery can present a risk of electrical shock and high short circuit current. The following precautions should be observed when working on batteries:
 1) Remove watches, rings, or other metal objects from the hands.
 2) Use tools with insulated handles.
 3) Wear rubber gloves and boots.
 4) Do not lay tools or metal parts on top of batteries.
 5) Disconnect charging source prior to connecting or disconnecting batteries terminals.
 • Servicing of batteries should be performed or supervised by personnel knowledgeable of batteries and the required precautions. Keep unauthorized personnel away from batteries.



Precautions for Safe Use

When moving the unit from a cold place to a warm place, leave it for several hours before using it.

- If the unit is promptly turned ON after being moved to a warmer place, condensation may form inside the unit and cause it to fail.

Charge the battery for at least 8 hours soon after purchasing the unit.

- If you do not use the unit for a long time after the purchase, the battery may deteriorate and the battery may become unusable.
- To charge a battery, connect the AC input plug of the unit to a wall outlet (commercial power).

When storing the unit, charge the battery for at least 8 hours and turn OFF the power switch.

- Even if the unit is not used, the battery gradually discharges, and if it is left for a long time, it goes into an over discharge state. The backup time may become shorter or the battery may become unusable.
- We recommend keeping the temperature 25°C or less when storing the unit for long periods of time. Connect the unit's AC input plug to a wall outlet (commercial power) for at least 8 hours at the following intervals:
 - Every 6 months when storage temperature is 25°C or less
 - Every 2 months when storage temperature is 40°C or less
- Turn off the power switch of the unit during storage.

Do not short the output lines of the unit to each other, and do not short the output lines to the ground.

- The unit may fail.

Do not connect the AC input plug of the unit to its Power Supply Output Receptacle during the Battery Mode.

- The unit may fail.

Do not connect a page printer (such as a laser printer) to the unit.

- The unit repeatedly and frequently switches between Commercial Power Mode and Battery Mode, which may shorten the life of the battery.
- The page printer has a large peak current, so an excess of the connection capacity or a power failure due to instantaneous voltage drop may be detected.

Check system operation beforehand if the unit is used in combination with a device whose power supply frequency fluctuates widely, such as a personal electric generator.

- The unit automatically recognizes the input power frequency when input power is supplied. If the unit is connected when the input power frequency is not stable at the rated level, the unit may misidentify the power supply frequency and may fail to operate normally. (If the unit is in operation, changing from commercial power supply to another power supply source, such as generating equipment, will cause no problem. Set the generator's frequency to the same level as that of the commercial power supply.)

Do not install or store the unit in a place exposed to direct sunlight.

- The rise of temperature may cause the built-in battery to deteriorate rapidly and become unusable.

Do not perform a withstand voltage test.

- The input circuit has a built-in surge absorption device. A withstand voltage test may break it.
- When performing an insulation resistance test, use the 400 V DC range.

Before stopping the commercial power to the unit, turn OFF the power switch of the unit.

- The unit enters Battery Mode when commercial power is stopped. If you frequently use the unit in Battery Mode, the battery life may be significantly shortened.

Check the operation beforehand if the unit is used in any mode other than "Output 220 V mode".

- In Battery Mode, the maximum voltage (peak voltage) of output (rectangular wave) may be lower than the maximum voltage in Commercial Power Mode. For this reason, some connected devices may fail to operate normally.

If this unit is used with an inductive device such as a coil or motor, check the operation beforehand.

- With some types of devices, the effect of inrush current may cause this unit to stop operating properly.

In the event you transfer or sell this unit to a third party, please include all of the documentation that came with the unit. This is to ensure that the unit is used in line with the conditions described in the included documentation.

- This manual contains important safety-related information. Please read and understand the contents of the manual before beginning operation.

Take measures for handling unforeseen accidents, such as data backup and system redundancy.

- The output may stop when there is a circuit failure in the UPS.

This unit uses lead acid batteries,

- Which are a valuable recyclable resource. Please recycle.



Precautions for Correct Use

Usual operation

- You may either leave the power switch of the unit ON (operation status) or turn it OFF each time when stopping the connected system. Choose whichever operation method is more convenient. We recommend turning OFF the power switch when you do not use connected devices for a long time.
- The battery can be charged once the AC input plug of the unit is connected to a wall outlet (commercial power).

Quitting Battery Mode

- If a power failure lasts for an extended period of time, the battery discharges and power output from the unit stops. Shut down your computer after performing appropriate procedures (for example, saving data) while the unit is still supplying power.

Rebooting

- If the battery discharges completely during a power failure, the unit stops. After recovery from the power failure, the unit automatically restarts and supplies power. If you do not want to restart the connected devices, turn OFF the power switch of either the unit or the connected devices.

Scheduled operation using the UPS monitoring software

- When performing scheduled operation in which the UPS is stopped and a device such as a breaker is used to stop the UPS at the same time that commercial power stops, specify a period of no more than 3 months for the start of the next operation. If you specify a period longer than 3 months, the internal timer is reset and the scheduled operation does not start. Note that this period reduces to approximately half when the battery is dead. If a period of 3 months is exceeded, you start operation by supplying commercial power and pressing the start switch. However, if the battery is dead, you may not be able to start operation. In this case, replace the battery.

Installation Method

This section describes how to install the UPS. Do not use this unit in any position other than the correct positions indicated in the illustration below.

Note: Before installing this device, make a record of the serial number of this device.
The serial number is required when contacting us about the device.
The serial number is written in the label on the unit's top side.

< BU1002SWG >

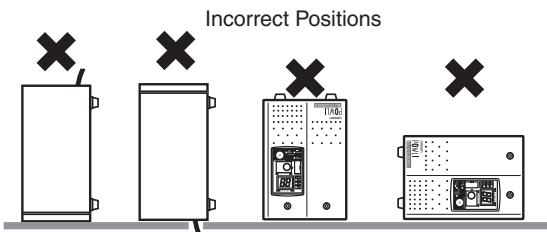
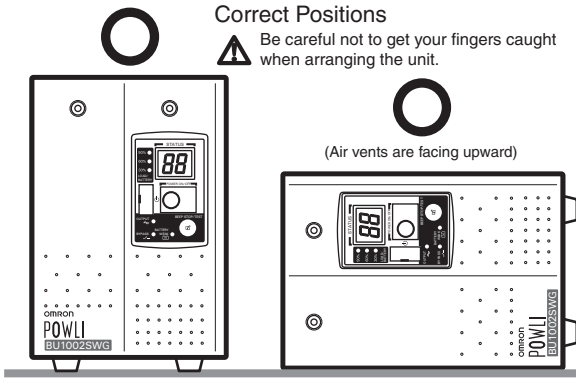

Note: The feet can also be anchored to the floor with screws if you use BUP100SG mounting brackets (sold separately). Refer to the BUP100SG instruction manual for more details.

< BU3002SWG >

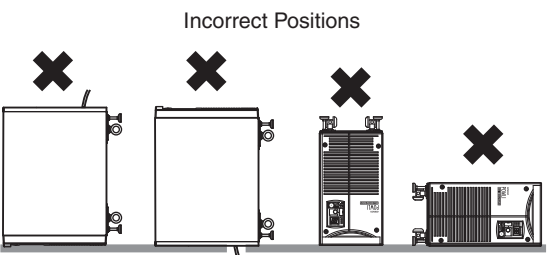
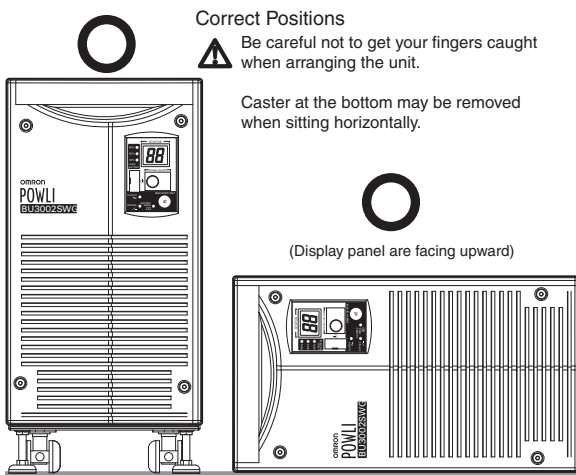

<Installing the BU3002SWG vertically>

Stabilize the casters

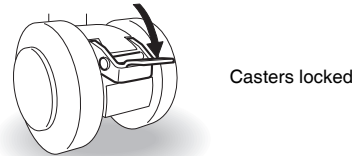
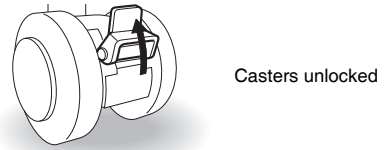

How to stabilize the fixed stand

Use a monkey wrench or spanner to loosen the fixed stand nuts. Unscrew the feet of the fixed stand until they reach the floor. Continue to unscrew the feet of the fixed stand until the casters no longer touch the floor.

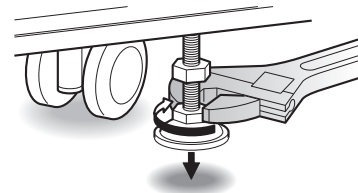

Once the fixed stand feet are firmly on the floor, turn the nuts counter-clockwise to tighten them and lock the feet in place.

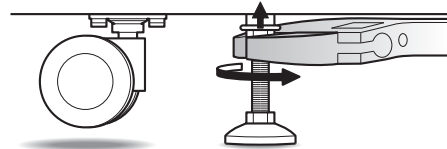

Note: The feet can be anchored to the floor with screws if you use BUP300SG mounting brackets (sold separately). Refer to the BUP300SG instruction manual for more details.

<Installing the BU3002SWG horizontally>

How to remove the bottom casters

Install the BU3002SWG so that the control panel is facing upward. Loosen the screws in the 6 locations shown in the diagram below. Remove caster mounting plate.

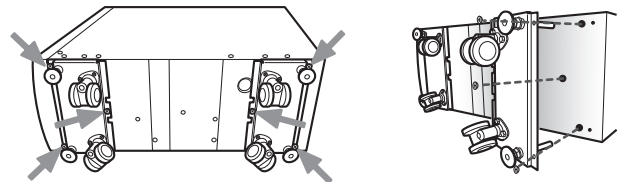

Note: BUP300SG mounting brackets (sold separately) can be used for easy mounting on an EIA/JIS 19-inch rack. Refer to the BUP300SG instruction manual for more details.

Terms and Conditions Agreement

Read and understand this catalog.

Please read and understand this catalog before purchasing the products. Please consult your OMRON representative if you have any questions or comments.

Warranties.

(a) Exclusive Warranty. Omron's exclusive warranty is that the Products will be free from defects in materials and workmanship for a period of twelve months from the date of sale by Omron (or such other period expressed in writing by Omron). Omron disclaims all other warranties, express or implied.

(b) Limitations. OMRON MAKES NO WARRANTY OR REPRESENTATION, EXPRESS OR IMPLIED, ABOUT NON-INFRINGEMENT, MERCHANTABILITY OR FITNESS FOR A PARTICULAR PURPOSE OF THE PRODUCTS. BUYER ACKNOWLEDGES THAT IT ALONE HAS DETERMINED THAT THE PRODUCTS WILL SUITABLY MEET THE REQUIREMENTS OF THEIR INTENDED USE.

Omron further disclaims all warranties and responsibility of any type for claims or expenses based on infringement by the Products or otherwise of any intellectual property right. (c) Buyer Remedy. Omron's sole obligation hereunder shall be, at Omron's election, to (i) replace (in the form originally shipped with Buyer responsible for labor charges for removal or replacement thereof) the non-complying Product, (ii) repair the non-complying Product, or (iii) repay or credit Buyer an amount equal to the purchase price of the non-complying Product; provided that in no event shall Omron be responsible for warranty, repair, indemnity or any other claims or expenses regarding the Products unless Omron's analysis confirms that the Products were properly handled, stored, installed and maintained and not subject to contamination, abuse, misuse or inappropriate modification. Return of any Products by Buyer must be approved in writing by Omron before shipment. Omron Companies shall not be liable for the suitability or unsuitability or the results from the use of Products in combination with any electrical or electronic components, circuits, system assemblies or any other materials or substances or environments. Any advice, recommendations or information given orally or in writing, are not to be construed as an amendment or addition to the above warranty.

See <http://www.omron.com/global/> or contact your Omron representative for published information.

Limitation on Liability; Etc.

OMRON COMPANIES SHALL NOT BE LIABLE FOR SPECIAL, INDIRECT, INCIDENTAL, OR CONSEQUENTIAL DAMAGES, LOSS OF PROFITS OR PRODUCTION OR COMMERCIAL LOSS IN ANY WAY CONNECTED WITH THE PRODUCTS, WHETHER SUCH CLAIM IS BASED IN CONTRACT, WARRANTY, NEGLIGENCE OR STRICT LIABILITY.

Further, in no event shall liability of Omron Companies exceed the individual price of the Product on which liability is asserted.

Suitability of Use.

Omron Companies shall not be responsible for conformity with any standards, codes or regulations which apply to the combination of the Product in the Buyer's application or use of the Product. At Buyer's request, Omron will provide applicable third party certification documents identifying ratings and limitations of use which apply to the Product. This information by itself is not sufficient for a complete determination of the suitability of the Product in combination with the end product, machine, system, or other application or use. Buyer shall be solely responsible for determining appropriateness of the particular Product with respect to Buyer's application, product or system. Buyer shall take application responsibility in all cases.

NEVER USE THE PRODUCT FOR AN APPLICATION INVOLVING SERIOUS RISK TO LIFE OR PROPERTY OR IN LARGE QUANTITIES WITHOUT ENSURING THAT THE SYSTEM AS A WHOLE HAS BEEN DESIGNED TO ADDRESS THE RISKS, AND THAT THE OMRON PRODUCT(S) IS PROPERLY RATED AND INSTALLED FOR THE INTENDED USE WITHIN THE OVERALL EQUIPMENT OR SYSTEM.

Programmable Products.

Omron Companies shall not be responsible for the user's programming of a programmable Product, or any consequence thereof.

Performance Data.

Data presented in Omron Company websites, catalogs and other materials is provided as a guide for the user in determining suitability and does not constitute a warranty. It may represent the result of Omron's test conditions, and the user must correlate it to actual application requirements. Actual performance is subject to the Omron's Warranty and Limitations of Liability.

Change in Specifications.

Product specifications and accessories may be changed at any time based on improvements and other reasons. It is our practice to change part numbers when published ratings or features are changed, or when significant construction changes are made. However, some specifications of the Product may be changed without any notice. When in doubt, special part numbers may be assigned to fix or establish key specifications for your application. Please consult with your Omron's representative at any time to confirm actual specifications of purchased Product.

Errors and Omissions.

Information presented by Omron Companies has been checked and is believed to be accurate; however, no responsibility is assumed for clerical, typographical or proofreading errors or omissions.

OMRON Corporation Industrial Automation Company
Kyoto, JAPAN

Contact: www.ia.omron.com

Regional Headquarters

OMRON EUROPE B.V.

Wegalaan 67-69, 2132 JD Hoofddorp
The Netherlands
Tel: (31)2356-81-300/Fax: (31)2356-81-388

OMRON ELECTRONICS LLC

2895 Greenspoint Parkway, Suite 200
Hoffman Estates, IL 60169 U.S.A.
Tel: (1) 847-843-7900/Fax: (1) 847-843-7787

OMRON ASIA PACIFIC PTE. LTD.

No. 438A Alexandra Road # 05-05/08 (Lobby 2),
Alexandra Technopark,
Singapore 119967
Tel: (65) 6835-3011/Fax: (65) 6835-2711

OMRON (CHINA) CO., LTD.

Room 2211, Bank of China Tower,
200 Yin Cheng Zhong Road,
PuDong New Area, Shanghai, 200120, China
Tel: (86) 21-5037-2222/Fax: (86) 21-5037-2200

Authorized Distributor:

© OMRON Corporation 2017-2019 All Rights Reserved.
In the interest of product improvement,
specifications are subject to change without notice.

Cat. No. U705-E1-02

1119(0517)