



Item No:

3650 00 12 (ultra-white)

3650 05 22 (aluminium)

With your purchase of a **Troll Comfort**, you have chosen a quality product manufactured by RADEMACHER. Thank you for the trust you have placed in us.

The **Troll Comfort** has been designed in order to provide optimal convenience and operability as well as to ensure solidity and durability. Having applied uncompromising quality standards and thorough testing, we are proud to be able to present this innovative product to you.

It is brought to you by all the highly-qualified personnel here at RADEMACHER.



These instructions...

...describe how to install, connect the electrical system and operate your **Troll Comfort**.



Before you begin, please read these instructions through completely and follow all the safety instructions.

Please store these instructions in a safe place and pass them on to any future owners.

Damage resulting from non-compliance with these instructions and safety instructions will void the guarantee. We assume no liability for any resulting damage.

1. Included in delivery	6	13.2 Connecting a light	23	18.5 Connecting a light sensor [6]	44
2. General view - operating unit	7	14. Assembly	24	18.5.1 Light sensor connection when using the supplied frame [2]..	45
3. Key functions	8	15. Brief description of the standard display and main menu	25	18.5.2 Light sensor connection when using a frame supplied by a third-party manufacturer	46
4. Display symbol legend	9	15.1 Opening and closing the menus (example: activating the random function)	26	18.5.3 Dismantling the light sensor [6]	48
5. Menu overview - main menu and system settings	10	16. Initial commissioning with the help of the installation wizard	27	18.6 Automatic dusk function; brief description	49
5.1 Menu overview - menu 9.8 device settings	11	17. Manual operation	31	18.6.1 Menu 3 - Customising the automatic dusk function [☾]	51
6. Key to symbols	12	17.1 Moving to a target position	32	18.7 Automated solar function; brief description	53
7. General safety information	13	18. Menu overview / main menu	33	18.7.1 Menu 4 - Configuring the automatic solar function [☀] ...	55
8. Proper use	14	18.1 [AUTO] Automatic mode; brief description	34	18.8 Automatic dawn function [☀]; brief description	57
9. Improper use	14	18.2 Menu 1- Automatic mode on/off	35		
10. Brief description	15	18.3 Switching times (opening and closing times) [▲/▼]; brief description.....	36		
10.1 Compatible switch ranges	16	18.4 Menu 2 - Configuration of opening and closing times [▲/▼]	41		
11. Overview of features	17				
12. Important information prior to electrical installation and mounting	19				
13. Safety instructions for electrical connection ...	21				
13.1 Connecting a tubular motor	22				

18.8.1 Menu 5 - Customising the automatic dawn time [☀] 57	19.4 Menu 9.4 - Set postcode 70	19.8.5 Menu 9.8.5 - Switch key lock on/off 82
18.9 Menu 6 - Configuring the random function [🎲] 59	19.5 Select Menu 9.5 - Switching time programme [🕒] 71	19.8.6 Menu 9.8.6 - Configuration of inputs E1 / E2 83
18.10 Automatic wind function [🌬]; brief description 60	19.6 Menu 9.6 - Configuration of blockage detection [🚫] 73	19.8.7 Menu 9.8.7 - Switch reversal of rotation direction on/off 85
18.10.1 Menu 7 - Configuration of the automatic wind function [🌬] .. 61	19.7 Menu 9.7 - Venetian blinds mode [🏠 / T]; brief description 76	19.8.8 Menu 9.8.8 - Light function; brief description 86
18.11 Rain function [☁]; brief description .. 62	19.8 Menu 9.8 - Device settings [🔧]; menu overview 78	19.8.9 Menu 9.8.9 - Configuration of end points for the tubular motor 89
18.11.1 Menu 8 - Configuring the automatic rain function [☁].. 63	19.8.1 Menu 9.8.1 - Automatic summer/winter changeover on/off 79	19.8.10 Menu 9.8.10 - Display software version 92
19. Menu 9 - System settings [🔧]; brief description 64	19.8.2 Menu 9.8.2 - Set display contrast 80	20. Software reset (restore factory settings) 93
19.1 Menu 9.1 - Set time and date [🕒] 65	19.8.3 Menu 9.8.3 - Configure continuous display backlighting 80	21. Hardware reset 94
19.2 Menu 9.2 - Configure motor running time 66	19.8.4 Menu 9.8.4 - Set clock mode ... 81	22. Dismantling 95
19.3 Menu 9.3 - Configure ventilation position [▼] 68		23. CE Mark and EC Conformity 96
		24. Technical Specifications 97

25. Works Settings	98
26. Time zone table	99
27. Accessories	101
28. Warranty conditions	102

i 1. Included in delivery

EN

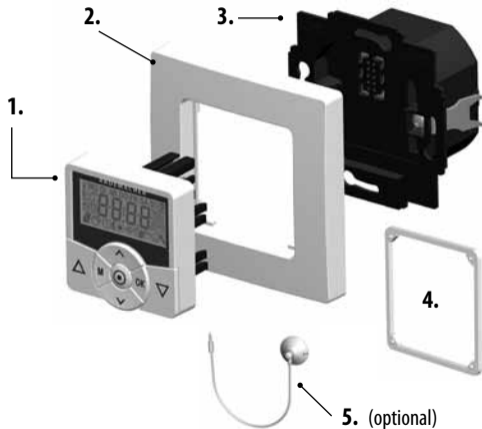

Legend

1. Control unit (50 x 50 mm)
2. Frame
3. Installation housing
4. Spacer frame, see page 47
5. Light sensor (optional), accessories, see page 101
6. 1 x operating manual (not illustrated)





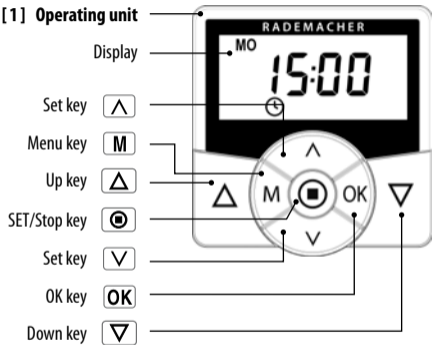

i 2. General view - operating unit





EN

[1] Operating unit



Connection socket for the light sensor.
Installation, see page 45

-  **Operating keys [Up / Down]**
- ◆ Manual operation [**Up**  / **Down** ].
-  **SET/Stop key, []**
- ◆ Manual roller shutter stop.
 - ◆ Configuration (setting) of various functions.
-  **Menu key, [M]**
- ◆ Call up the main menu.
 - ◆ Go back or return to the standard display.

-  **Set keys, [ / ]**
- ◆ Select the desired menu item.
 - ◆ Setting the parameters (increase / decrease) / pressing and holding a key for an extended period causes the digits to change more quickly.
-  **[OK] key**
- ◆ Confirm and open the selected menu.
 - ◆ Confirm entry.
 - ◆ Continue to next entry.

i 4. Display symbol legend

EN



[MO ... SO] (MON...SUN) Week days

88:88 Time / setting parameters

i Information

 Switching programme

[OFFSET] OFFSET (for Astro time)

[SET] Setting

[AUTO] Automatic operation

[PLZ] Postcode

[IST] ACTUAL value

 Direction of travel - up / down

 Automatic mode off

 Timer periods

 Automatic dusk function

 Automated solar function

 Automatic dawn function

 Random function

 Automatic wind function

 Rain function

 System settings

[SOLL] SET value

 Automatic slat adjustment

[T] Jog mode

[L] Light function

[NORMAL] Switching modes

[ASTRO]

[SENSOR]

[%] Dimension (percent)

 Blockage detection

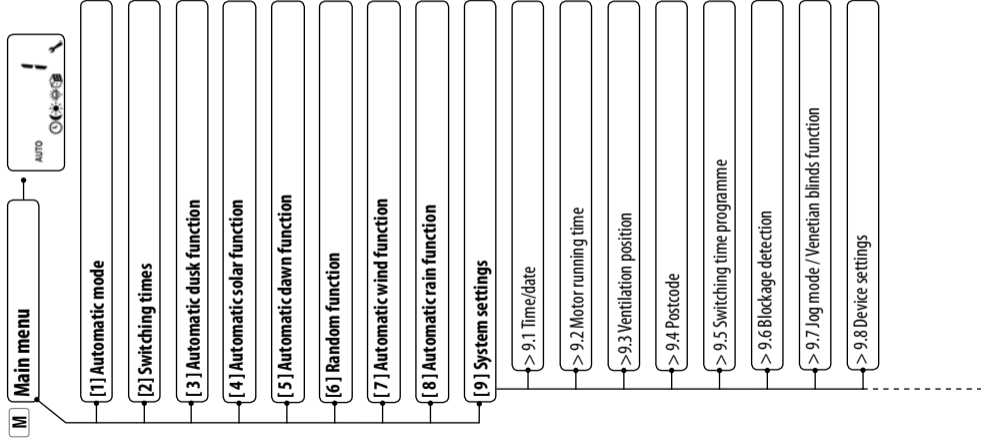

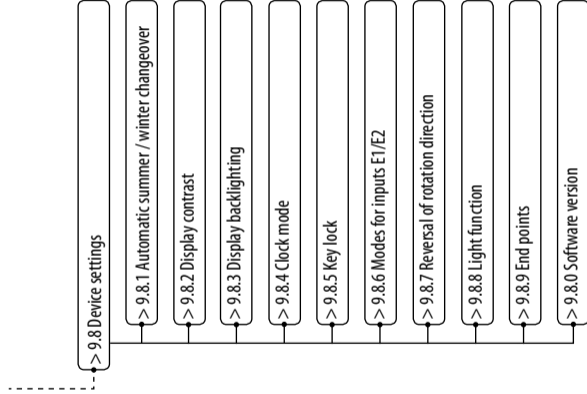

i 6. Key to symbols

EN



Risk of fatal electric shock.

This symbol warns of danger when working on electrical connections, components, etc. It requires that safety precautions be taken to protect the life and health of the person concerned.



This concerns your safety.



Please pay particular attention and carefully follow all instructions marked with this symbol.

NOTE / IMPORTANT / CAUTION

In this way, we wish to make you aware of the following content in order to ensure optimal functionality.



Please read the operating instructions for external devices described at this point, (e.g. a tubular motor).



Danger due to electric shock when working on all electrical systems.

- ◆ The electrical connection and all work on electrical systems must only be carried out by a qualified electrician in accordance with the connection diagram in these operating instructions, see page 22.
- ◆ Carry out all installation and connection work only in an isolated, de-energised state.



The use of defective equipment can lead to personal injury and damage to property (electric shocks, short circuiting).

- ◆ Never use defective or damaged equipment. Please contact our Customer Service department in the event of faults, see page 104.



Incorrect use leads to an increased risk of injury.

- ◆ Children must not be permitted to play with the Troll Comfort.
- ◆ Train all personnel to use the Troll Comfort safely.
- ◆ Avoid allowing persons with limited abilities to operate the equipment and prevent children from playing with fixed controllers.
- ◆ Never remove the operating unit from the installation housing during operation.

i 8. Proper use

EN

Only use the **Troll Comfort** for connecting and controlling a tubular motor for:

- ◆ Roller shutters
- ◆ Venetian blinds and slats
- ◆ Awnings
or
- ◆ Controlling lights or other electrical appliances

Operating conditions:

- ◆ The tubular motor must be fitted with a mechanical or electronic end position switch.
- ◆ Only operate the Troll Comfort in dry rooms.
- ◆ A 230V / 50 Hz power supply, together with a site-provided disconnecting device (fuse, MCB), must be available at the installation location.

i 9. Improper use

Using the Troll Comfort for purposes other than those previously mentioned is impermissible.

- ◆ Do not install the Troll Comfort outside.

The **Troll Comfort** controller is designed for controlling roller shutters, Venetian blinds, slats or awnings by connecting a corresponding tubular motor as well as lights (or other electrical appliances).



Roller shutter control

The system enables roller shutters to be automated.

Manual operation

It is possible to manually control the connected tubular motor at any time by using the controls.

Central control of several Troll Standard controllers

The Troll Comfort can also be used as a central controller for several Troll Standard controllers, as an alternative to connecting a tubular motor. You can obtain additional connection and circuit examples from our website at www.rademacher.de

External controller via the two inputs E1 and E2.

The Troll Comfort features two configurable inputs **E1** and **E2** (230 V / 50 Hz) for connecting external signal transducers (e.g. Venetian blinds switch / environmental sensor, etc.), see page 83.

Brief description of the blockage detection function

The Troll Comfort is able to monitor the torque of motors equipped with a **mechanical end point setting**. This enables the controller to switch off the motor in the event of overloading or blockage, see page 73.

Assembly

The Troll Comfort can be integrated into most commercially available switch ranges with the help of a corresponding intermediate frame 50 x 50 (DIN 49075). Suitable switch ranges are detailed on the following page.

i 10.1 Compatible switch ranges (please also refer to www.rademacher.de)

EN

Manufacturer	switch range
BERKER	Arsys / K1 / S1
BUSCH-JAEGER	Busch-Duro 2000 Si / Reflex Si / alpha exclusive / alpha nea / solo / impuls
GIRA	Standard-System / S-Color System / stainless steel range / Standard 55
JUNG	CD 500 / ST 550 / LS 990 / CDplus and CD, however, with coloured rings
MERTEN	M1 / Atelier / Artec / Tracent / Antique New
PEHA	Standard / Dialog / Aura
LEGRAND	Creo / Tenara
VEDDER	Alessa (plus)

NOTE

- ◆ It may be necessary to use an intermediate frame 50 x 50 * (DIN 49075), depending on the switch range used.
- ◆ Certain switches require the supplied spacer frame [8] to be installed when using the RADEMACHER light sensor **.

* not included

** accessories, see page 101.

- ◆ Display background illumination
- ◆ Installation wizard for easy commissioning
- ◆ Configurable blockage detection for mechanical tubular motors
- ◆ Manual operation on site
- ◆ Direct configuration and movement to a target position
- ◆ Switching automatic mode on/off
- ◆ Easy configuration with menu-driven operation
- ◆ Timer periods
 - Configuration of opening [▲] and closing times [▼] for your roller shutters
- ◆ Switching programme:
 - Weekly switching times
 - One switching time pair [▲/▼] for (MON...SUN) [MO...SO]
 - Weekday and weekend switching times
 - One switching time pair [▲/▼] for (MON...FRI) [MO...FR]
 - One switching time pair [▲/▼] for (SAT + SUN) [SA + SO]
 - Individual day switching times
 - One switching time pair [▲/▼] for every day of the week (MO / TU / WE / TH / FR / SA / SU) [MO / DI / MI / DO / FR / SA / SO]
 - Activate a second switching time block
 - Double switching times (see page 37/71)
- ◆ Automatic dusk function
 - Automatic darkness function with the Astro program
 - Automatic darkness function with connected light sensor

- ◆ Automatic solar function (with light sensor)
- ◆ Automatic dawn function with the Astro program
- ◆ Random function (random delay of 0 to 30 minutes)
- ◆ Ventilation position
- ◆ End point setting
- ◆ Key lock
- ◆ Blinds mode
 - Automatic slat adjustment
 - Jog mode
 - Setting the running time
- ◆ Automatic wind function
- ◆ Rain function
- ◆ Light function (controlling electrical appliances)
- ◆ Switching reversal of rotation direction on/off

- ◆ Automatic summer / winter changeover
- ◆ Permanent storage of the settings
- ◆ External control via the two configurable inputs **E1 / E2**

Description and configuration of the individual functions

A precise description of the individual functions and settings is included starting on page 25.

i 12. Important information prior to electrical installation and mounting

EN



Installation and electrical connection of the Troll Comfort may only be undertaken with the supplied installation housing [3].

The connecting terminals [4] are located at the bottom of the installation housing [3].

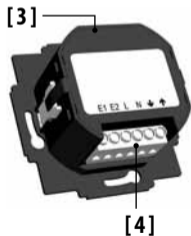

NOTE

Installation housings for other variants of the Troll controller are not compatible.



You must configure the end stops for the tubular motor before using for the first time and making the final electrical connection.

- ◆ If no end stops are configured, then it is vital that both end points are configured for the tubular motor, as failure to do so can lead to malfunctions.
- ◆ In order to do so, follow the information provided in the operating manual for the appropriate tubular motor.



Parallel connection of electronic tubular motors

A maximum of 3 tubular motors can be connected in parallel to the Troll Comfort (e.g. RADEMACHER electronic tubular motors).



To do so, please refer to the operating manual for the corresponding tubular motor.

Parallel connection of mechanical tubular motors

A cut-off relay is required in order to connect mechanical tubular motors in parallel.

Requirements for blockage detection

Blockage detection is only operational if a **mechanical tubular motor** is connected.

Function of inputs E1 and E2

Both inputs can be configured independently of each other. You can configure the functions of the inputs in menu **9.8.6**, depending on the required purpose of the connected signal transducers, see page 83.

You can obtain connection and circuit examples from our website at **www.rademacher.de**

i 13. Safety instructions for electrical connection



Danger due to electric shock when working on all electrical systems.

- ◆ The electrical connection and all work on electrical systems must only be carried out by a qualified electrician in accordance with the connection instructions in these operating instructions.
- ◆ Carry out all installation and connection work only in an isolated, zero-volt state.
- ◆ Disconnect all phases of the mains power supply cable and secure it to prevent any reconnection.
- ◆ Check the system for a zero-voltage status.
- ◆ Prior to connecting, compare the information about voltage / frequency on the device with that of the local electrical grid operator.



Incorrect wiring may lead to short-circuits and destroy the device.

- ◆ Follow the pin assignment detailed in the wiring diagram.
- ◆ Follow all the electrical connection specifications in the operating instructions of your tubular motor and that of the external controller (when using E1/E2).



Connection of a second phase to E1 or E2 will cause the Troll Comfort to be damaged.

- ◆ When **inputs E1 / E2** are used, they must always be connected to the **same phase**.
- ◆ If another phase is connected, the **incorrect mains voltage (380 V / 50 Hz)** will be applied to the inputs and damage the Troll Comfort.

i 13.1 Connecting a tubular motor

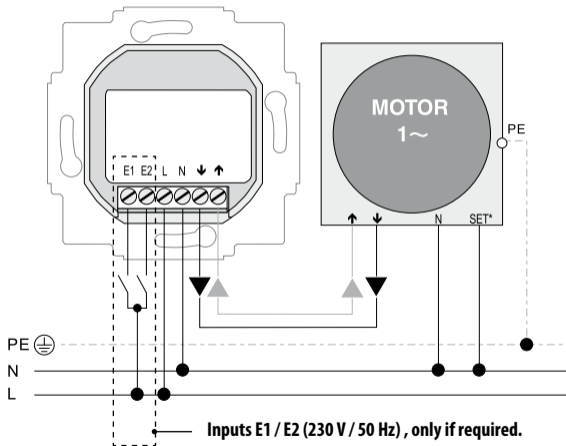

Connecting the white set cord (SET) from RADEMACHER tubular motors

- * The **white set cord (SET)** from RADEMACHER tubular motors must be connected to the **neutral terminal [N]** to ensure trouble-free operation of the tubular motor.

i 13.2 Connecting a light

If required, you can connect a garden light (or other electrical appliance) to the controller instead of a tubular motor and use the light function to control it, see page 86, menu **9.8.8 [light function configuration]**.

NOTE:

The maximum switching capacity is 500 W.

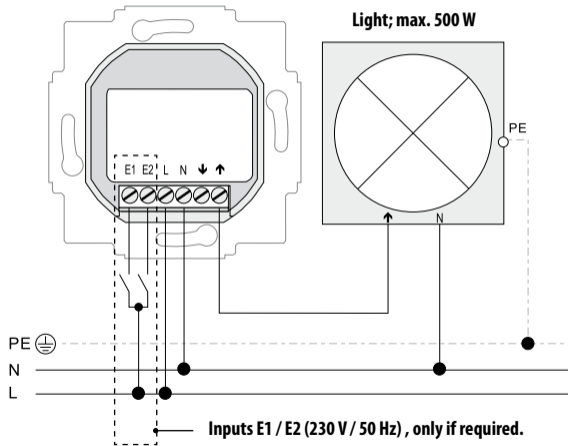

i 14. Assembly

EN

The Troll Comfort is designed for flush-mounted installation. For this, you require a **58-mm flush-mounted** box. We recommend using a deep box.

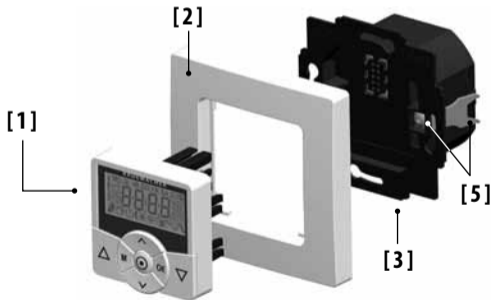

Installation procedure:

1. Switch off the mains.
2. Make the electrical connection according to the wiring diagram (see page 22 / 23).
3. Route the power cables to the flush-mounted box.
4. Slide the installation housing [3] into the flush-mounted box and clamp the claws [5] in place with the screws provided.
5. Fit the frame [2].
6. Carefully insert the operating unit [1] into the installation housing [3].
7. Switch the mains power back on again.

Mounting the light sensor, see page 44.

i 15. Brief description of the standard display and main menu

The standard display (example)



- ◆ Displays the current day of the week and time.
- ◆ Displays the activated functions.
- ◆ Manual operation of the Troll Comfort is only possible from the standard display.

The main menu

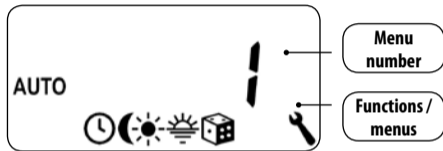

- ◆ Enables display and selection of the individual functions and menus.
- ◆ Manual operation is not possible from the main menu.
- ◆ No automatic control commands will be executed during the configuration process.
- ◆ If no key is pressed within 120 seconds, the display automatically changes from the active menu back to the standard display. Changes to settings are nevertheless saved.

i 15.1 Opening and closing the menu (example: activating the random function)

EN

1. Call up the **main menu**.
By pressing the [M]-key in the standard display.



2. Select the desired **menu** or menu number.



The selected menu is indicated by a **flashing icon**.

3. Open the menu by pressing the [OK] button.



4. Select the desired setting and confirm with [OK].



5. Subsequently the **main menu** will be displayed again.



NOTE

Pressing the [M]-key from any of the menus will return you to **the standard display**.



approx.
1 sec.

i 16. Initial commissioning with the help of the installation wizard

An installation wizard is available in order to help you configure the Troll Comfort quickly and easily. The wizard automatically guides you through the configuration process **for initial commissioning or after a software reset (see page 93)**.

Quitting the installation wizard

Pressing the [M] key for one second causes the installation wizard to be cancelled prematurely.

Readiness for operation

The Troll Comfort is ready for use as soon as the installation wizard has finished.

In addition, you can individually customise your settings and make changes at any time from the main menu and the system settings menu.

1. Set and confirm the **time**.



NOTE

Pressing a set key for an extended period causes the numbers to progress more quickly.

2. Set and confirm the **date**.



3. Set and confirm the **year**.

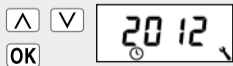

i 16. Initial commissioning with the help of the installation wizard

EN

4. Set and confirm the first two digits of your **German postcode [PLZ]** or the desired **international time zone**.

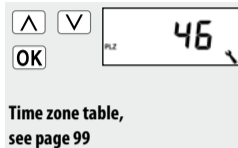

5. Set and confirm the **opening time [▲]**.

Pre-setting:

This closing time mode applies to the entire week (MON...SUN) [**MO...SO**].

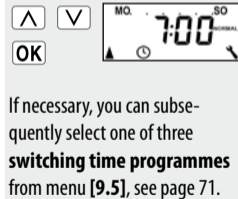

- a) Configure the **switching time mode for the opening time [▲]**.

NORMAL

The roller shutters open at the configured opening time.

ASTRO

The roller shutters open at the daily calculated dawn time.

Switching time mode

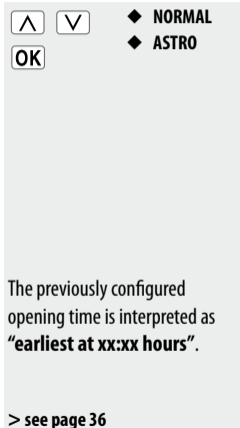

i 16. Initial commissioning with the help of the installation wizard

b) If [ASTRO] is selected, then the calculated opening time for the current day is displayed.



c) Continue to set the closing time.



6. Set and confirm the closing time [▼].



If necessary, you can subsequently select one of three **switching time programmes** from menu [9.5], see page 71.

Pre-setting:

This closing time mode applies to the entire week (MON...SUN) [MO...SO].

a) Configure the **switching time mode for the closing time [▼]**.

NORMAL

The roller shutters close at the configured closing time.

ASTRO

The roller shutters close at the daily calculated dusk time.



- ◆ NORMAL
- ◆ ASTRO
- ◆ SENSOR

The previously configured closing time is interpreted as "**latest at xx:xx hours**".

i 16. Initial commissioning with the help of the installation wizard

EN

SENSOR

The roller shutters close every day at dusk, as measured by the light sensor.

Switching time mode

- b) If **[ASTRO]** is selected, then the calculated closing time for the current day is displayed.
- c) Confirm the setting.

The previously configured closing time is interpreted as “**latest at xx:xx hours**”.

> See page 36

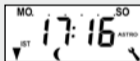

OK

- 7. **The standard display** is shown as soon as the final setting is confirmed.

The Troll Comfort is now ready for operation.

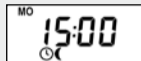





Example

NOTE

You have the option of deactivating individual switching times as required. In order to do so, the value **[OFF]** can be selected after the value **[23:59]**.

Manual operation is possible from the standard display at any time and has priority over the programmed automatic functions.

Example for manual control of a roller shutter

1.  **Open the roller shutters.**
Briefly pressing the button causes the roller shutters to move to the **upper end point**.
2.  /  or  **Causes the roller shutters to stop in the interim.**
3.  **Closing the roller shutters.**
Briefly pressing the button causes the roller shutters to move to the **configured ventilation position** or to the **lower end point**.



Ventilation position, see page 68

If the ventilation position is configured, the roller shutters will first roll down to this position.

Pressing the [**Down**] key once more causes the roller shutters to continue downwards.

If necessary, you can enter an arbitrary **target position** for your roller shutters which you can then move to directly. The Troll Comfort is able to move to the target position and stop the roller shutters fully independently and automatically. It is not necessary to give an additional manual movement or stop command.

Automatic movement after approx. two seconds.

The system will initiate movement to the configured target position automatically if no button is pressed for approx. two seconds.

NOTE

- ◆ In order to use this function, it is necessary to previously determine and configure the **running time** for the connected tubular motor, see page 66.
- ◆ The ventilation position is ignored when moving to the target position.

1. Display the current position of the roller shutters by briefly pressing one of the buttons.



The current position is given as a **percentage** [%].

2. Enter the desired target position by repeatedly pressing the key (e.g. 20 %).



The arrows [▲/▼] indicate the resulting direction of travel.









3. The roller shutters will automatically move to the target position and stop after approx. two seconds.

Value = roller shutter position:

0 % = fully opened

100 % = fully closed

Main menu

Icon	Menu	Page
AUTO	1 Automatic mode	34
	2 Switching times	36
	3 Automatic dusk control	49
	4 Automatic solar function	53
	5 Automatic dawn control	57
	6 Random function	59
	7 Automatic wind function	60
	8 Automatic rain function	62
	9 System settings	64

Standardised menu structure for Troll range

A standardised, cross-variant menu structure has been developed for all Troll models, featuring an identical set of menu numbers for each of the menus.

Menu items 7 and 8 are only available if inputs E1 and E2 have been correspondingly configured, see page 83.

Automatic mode on

All of the activated automatic functions will be executed if the automatic mode is switched on. The corresponding icon is then shown in the standard display.

NOTE

- ◆ Manual operation is also possible in automatic mode.
-

Automatic mode off



Icon in standard display

- ◆ All automatic functions are deactivated; only manual operation is possible.
- ◆ All automatic icons are switched off in the standard display.
- ◆ Inputs E1 and E2 will not be taken into consideration, unless the automatic wind function is activated.

OK Toggle directly to the standard display

- To do so, press and hold [OK] for approx. one second.

OK
approx.
1 sec.

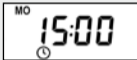

Automatic mode
on

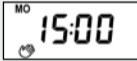

Automatic mode
off

Switch on/off in menu 1

- Call up the main menu.
 - Select and open menu 1 [AUTO].
 - Select and confirm the desired setting.
- On** = Automatic mode on
OFF = Automatic mode off

M

^ V
OK



^ V
OK



MO 15:00

18.3 Switching times (opening and closing times) [▲/▼]; brief description

EN

You can configure various **opening [▲] and closing times [▼]** for the Troll Comfort in order to open or close your roller shutters at your preferred times.

For this purpose, there are three switching time programmes available in menu 9.5 [] see page 71:

[1] Weekly switching times (factory setting)

- ◆ One switching time pair [▲/▼] for (MON...SUN) [**MO...SO**]

[2] Working day and weekend switching times

- ◆ One switching time pair [▲/▼] for (MON...FRI) [**MO...FR**]
- ◆ One switching time pair [▲/▼] for (SAT + SUN) [**SA + SO**]

[3] Individual day switching times

- ◆ One switching time pair [▲/▼] for every day of the week (MO / TU / WE / TH / FR / SA / SU)
[**MO / DI / MI / DO / FR / SA / SO**]

🕒 18.3 Switching times (opening and closing times) [▲/▼]; brief description

EN

Double the amount of switching times by activating a second switching time block:

If necessary you can double the amount of available opening and closing times. In order to do so, a second **switching time block (n = 2)** must be activated in **menu 9.5** [🔑], see page 71.

IMPORTANT

If a second switching time block has been activated [n 2], you can select the desired switching time block (1,2) prior to setting the opening and closing times.

NOTE

The switching times in the second switching time block [2] cannot be linked to a **switching time mode [NORMAL / ASTRO / SENSOR]**.

Application example for a second switching time.

You can use a second switching time, for example, to darken a child's bedroom at midday:

- The **first opening time** has been set to 8:00 hours.
- The roller shutters will open at 8:00 hours.
- The roller shutters should close again at 12:00 hours and open again at 14:30 hours.
- In order to do so, a **second switching time block** must be selected and the appropriate **second opening and closing time** must be set.
- The **first closing time** was set to 20:00 hours.
- The roller shutters close at 20:00 hours.

Selecting a switching time mode.

Various **switch time modes** can be selected when configuring the opening and closing times.

The following switching time modes are possible:

- ◆ **NORMAL**
- ◆ **ASTRO**
- ◆ **SENSOR (only for closing times)**

Brief description of the switching time modes.

- ◆ **NORMAL**
The roller shutters move at the configured switching time.

◆ **ASTRO**

Calculation of the appropriate switching time by means of an “Astro” programme.

The opening and closing times are calculated in relation to the date and postcode. Subsequently they are linked to the previously configured switching times.

■ **Link to the opening time [▲]**

The roller shutters open at the daily calculated dawn time. The configured **opening time** is interpreted as “**earliest at xx:xx hours**”.

■ **Example a:**

- Dawn begins at 5:00 hours.
- The opening time has been set to 7:00 hours.
- Your roller shutters will open at 7:00 hours.

■ Example b:

- Dawn begins at 08:00 hours.
- The opening time has been set to 7:00 hours.
- Your roller shutters will open at 08:00 hours.

■ Link to the closing time [▼]

The roller shutters close at the daily calculated dusk time. The previously configured closing time is interpreted as **“latest at xx:xx hours”**.

■ Example a:

- Dusk begins at 17:00 hours.
- The closing time has been set to 20:00 hours.
- Your roller shutters will close at 17:00 hours.

■ Example b:

- Dusk begins at 22:00 hours.
- The closing time has been set to 20:00 hours.
- Your roller shutters will close at 20:00 hours.

◆ SENSOR (only for closing times [▼])

The closing time is controlled by a light sensor in relation to the level of brightness.

In addition, the measured twilight value is linked to the previously configured closing time. The configured closing time is interpreted as **“latest at xx:xx hours”**.

■ Example a:

- In winter dusk begins, for example, at approx. 17:00 hours.
- The closing time has been set to 20:00 hours.
- Your roller shutters will close at 17:00 hours.

■ Example b:

- In summer dusk begins, for example, at approx. 22:00 hours.
- The closing time has been set to 20:00 hours.
- Your roller shutters will close at 20:00 hours.

NOTE

You have the option of deactivating individual switching times as required. In order to do so, the value [**OFF**] can be selected after the value [**23:59**].

Subsequently the switching time will not be executed (even in ASTRO or SENSOR modes).



18.4 Menu 2 - Configuration of opening and closing times [▲/▼].

1. Please check to see whether the desired switching time programme is configured.

See menu [9.5], page 71

2. Call up the main menu.

M

3. Select and open menu 2 [🕒] **Switching times.**

▲

▼

OK



Weekly switching times



Weekday / weekend switching times



The display header indicates which switching programme is currently active.

The following serves to describe the procedure for setting an **opening and closing time [▲/▼] as a weekly switching time.**

4. Activate and confirm the switching times.

On = Switching times on
OFF = Switching times off

Individual day switching times



▲

▼

OK





18.4 Menu 2 - Configuration of opening and closing times [▲/▼].

EN

5. Set and confirm an **opening time** [▲].



- a) Configure the **switching time mode for the opening time** [▲].



NORMAL

The roller shutters open at the configured opening time.

ASTRO

The roller shutters open at the daily calculated dawn time.

The previously configured opening time is interpreted as **“earliest at xx:xx hours”**.

Switching time mode >

See page 36

- b) If [ASTRO] is selected, then the calculated opening time for the current day is displayed.



- c) Continue to set the closing time.



6. Set and confirm a **closing time** [▼].

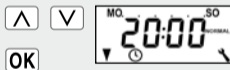

- a) Configure the **switching time mode for the closing time** [▼].





18.4 Menu 2 - Configuration of opening and closing times [▲/▼].

EN

NORMAL

The roller shutters close at the configured closing time.

ASTRO *

The roller shutters close at the daily calculated dusk time.

SENSOR*

The roller shutters close every day at dusk, as measured by the light sensor.

Switch time mode,
see page 36.

*

The previously configured closing time is interpreted as “**latest at xx:xx hours**”.

b) If [ASTRO] is selected, then the calculated closing time for the current day is displayed.

c) Return to main menu.

OK

7. Return to standard display after making the final setting.

M

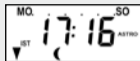



18.4 Menu 2 - Configuration of opening and closing times [▲/▼].

EN

INFORMATION ABOUT THE [ASTRO] SWITCHING TIME MODE

- ◆ If [ASTRO] is selected as the switching time mode, the calculated darkness time can be individually customised by means of an offset between **-60** and **+60** minutes.
 - Dusk can be configured in **menu 3**, see page 49.
 - Dawn can be configured in **menu 5**, see page 57.

INFORMATION ABOUT THE [SENSOR] SWITCHING TIME

MODE

- ◆ If [SENSOR] is selected as the switching time mode, then the desired **twilight limit value** can be configured in **menu 3**, see page 49.



18.5 Connecting a light sensor [6]

If you intend to operate your Troll Comfort and the connected tubular motor according to brightness levels, then you must connect the optionally available RADEMACHER light sensor [6] to the Troll Comfort.



Excessive bending can damage the sensor cable.

The sensor cable is a fibre optic cable. Avoid excessive bending or crushing of the sensor cable.

i 18.5.1 Light sensor connection when using the supplied frame [2].

EN

1. Carefully pull the operating unit [1] away from the installation housing [3].
2. Insert the light sensor plug * [6] into the socket [7] on the rear of the operating unit [1].
3. Feed the sensor cable into the cable bushing in the frame [2] and guide it out.
4. Carefully replace the operating unit [1] with frame [2] back onto the installation housing [3].

* Accessories, see page 101.

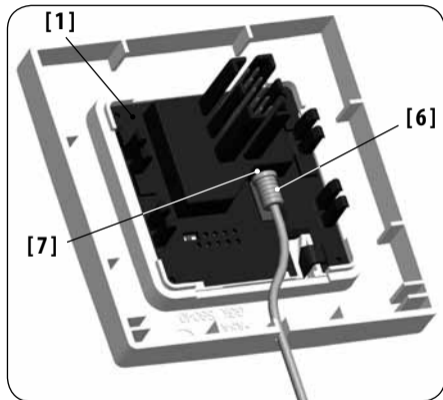

i 18.5.2 Light sensor connection when using a frame supplied by a third-party manufacturer.

EN

1. Carefully pull the operating unit [1] away from the installation housing [3].
2. Insert the light sensor plug [6] into the socket [7] on the rear of the operating unit [1].
3. Lay the sensor cable in the cable bushing of the operating unit. The sensor cable can be pressed into the engagement hooks with the help of a rounded object (for example, a 50 cent coin).
4. Carefully replace the operating unit [1] together with the frame back onto the installation housing [3].

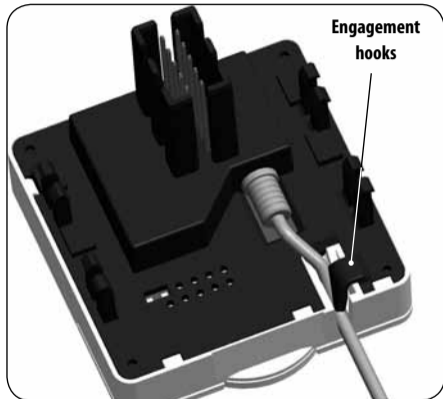

i 18.5.2 Light sensor connection when using a frame supplied by a third-party manufacturer.

EN

NOTE

- ◆ If the cable bushing of the operating unit [1] is covered by the frame, then it will be necessary to fit the additionally provided spacer frame [8] onto the rear of the operating unit [1].
- ◆ It may also be necessary to use an intermediate frame [9] 50 x 50 * (DIN 49075), depending on the respective switch range used.

* not included

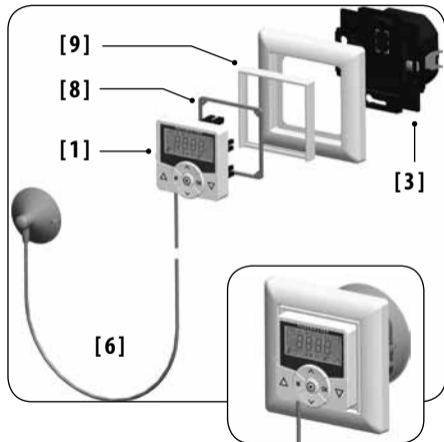

i 18.5.3 Dismantling the light sensor [6].

1. Carefully pull the operating unit [1] away from the installation housing [3].
2. If the sensor cable has been fixed in place by means of the operating unit's [1] engagement hooks, then it must first be released, for example, with the help of a 50 cent coin.
3. Pull the light sensor plug [6] out of the socket [7].
4. Replace the operating unit [1] back onto the installation housing [3].

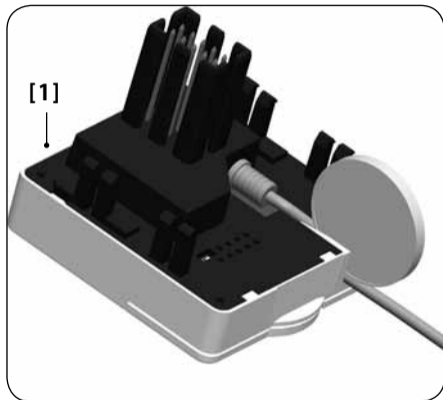

The automatic dusk function causes the roller shutters to automatically close to the lower end point or to the configured ventilation position.

You can choose between two automatic dusk functions:

- ◆ Automatic dusk function with “Astro” programme
= switching time mode [**ASTRO**]
- ◆ Automatic dusk function with light sensor
= switching time mode [**SENSOR**]

Automatic dusk function with “Astro” programme

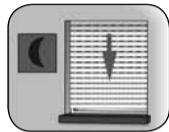

The twilight time is recalculated every day based on the geographical location and the current date (defined by the configured postcode). This means that it is not necessary to continuously readjust the closing time throughout the year.

Configure a custom offset period

An offset can be configured between **-60** and **+60 minutes** in order to customise the calculated dusk time to your personal preferences.

A light sensor is not required for this function.



Automatic dusk function with connected light sensor

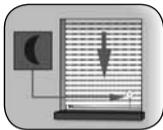

At twilight, the roller shutters will lower to the lower end limit or to the configured ventilation position after approx. 10 seconds. The roller shutters will open again once the configured opening time is reached or in the event of a manual command.

The required twilight limit is configurable.

NOTE

The automatic dusk function via light sensor is only executed once per day.

Mounting the light sensor, see page 44.

☾ 18.6.1 Menu 3 - Customising the automatic dusk function [☾].

1. Call up the main menu.

M

2. Select and open menu 3
[☾] **Automatic dusk
function.**



3. Customise the automatic
dusk function in accord-
ance with the selected
switching time mode.

- 3.1. [NORMAL]

No customisation is possi-
ble in this mode.

- a) Return to main menu.

OK

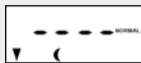

- 3.2. [ASTRO]

Setting an offset.

The offset function can
be used to modify the
calculated Astro time by
+/- 60 minutes.

^ v
OK

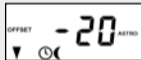

Example

With a negative offset e.g. **"- 10"**,
the calculated Astro time is trig-
gered 10 minutes earlier.

18.6.1 Menu 3 - Customising the automatic dusk function [C].

EN

- a) Subsequently, the resulting closing time is displayed.
- b) Return to main menu.

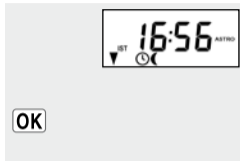

- 3.3. [SENSOR]
Customisation of the **twilight limit value** in switch time mode [SENSOR].

If the set limit value is not met due to the onset of twilight, the roller shutters will close.

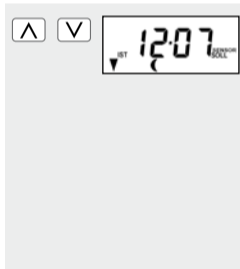

Actual value [IST]

Currently measured brightness (e.g. 12).

"- -" = too bright

SET value [SOLL]

Configurable set limit

- 01 = very dark,
approx. 2 Lux
- 15 = less dark,
approx. 50 Lux

- a) Return to main menu.

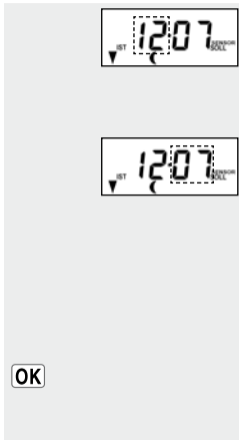



18.7 Automated solar function; brief description

EN

The automated solar function enables brightness-dependent control of your roller shutters. To do this, the light sensor is secured to the window pane with a sucker and then plugged into the Troll Comfort.

Automated solar function

Automatic moving of the roller shutter once a set limit is exceeded. The roller shutter end position can be freely selected by changing the light sensor position.



Please note the state of the sun icon on the standard display.

When the automated solar function is active, the sun icon flashes in the standard display as soon as the configured set limit is exceeded.

Automatic lowering

If the sensor detects uninterrupted sunlight for 10 minutes, the shutter will descend until its shadow covers the light sensor.

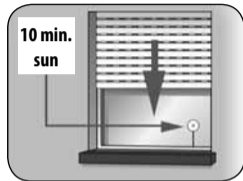



Automatic clearing

After approx. 20 minutes, the roller shutter is automatically raised a small amount to uncover the sensor. If the sun continues to shine, then the roller shutter remains in this position. If the brightness decreases below the set limit, it returns to the upper end point.

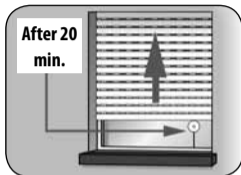

NOTE



The above mentioned delay times can be exceeded in the event of changing weather conditions.

The automated solar function will be terminated and must be reactivated if required after the following events:

- ◆ After manual activation.
- ◆ After execution of an automatic function.
- ◆ After the upper end point is reached.

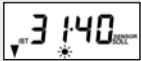

18.7.1 Menu 4 - Configuring the automatic solar function [☀].

- | | |
|--|--|
| 1. Call up the main menu. | M |
| 2. Select and open menu 4 [☀] Automatic solar function. | <div style="display: flex; justify-content: space-around; align-items: center;"> ▲ ▼  </div> <div style="margin-top: 5px;">OK</div> |
| 3. Activate and confirm the automated solar function. | <div style="display: flex; justify-content: space-around; align-items: center;"> ▲ ▼  </div> <div style="margin-top: 5px;">OK</div> |
| On = on
OFF = off | |
| 4. Customising the solar set limit. | <div style="display: flex; justify-content: space-around; align-items: center;"> ▲ ▼  </div> |

Actual value [IST]

Currently measured brightness (e.g. 31).

"- -" = too dark

SET value [SOLL]

Configurable set limit

31 = minimal sun,
approx. 2000 Lux

45 = bright sunlight
approx. 20000 Lux

- a) Return to main menu or continue with point 5.

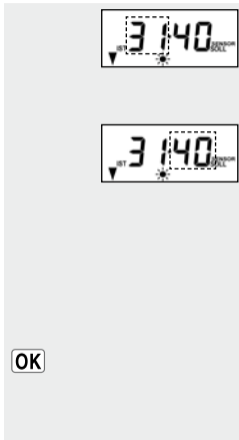



18.7.1 Menu 4 - Configuring the automatic solar function [☀].

EN

If the automatic slat adjustment function is activated (see page 76), then the sunshine position must be configured in the next stage.

5. Move the roller shutters to the desired sunshine position.



or

5. Enter the desired sunshine position by modifying the percentage value.



Example

0 % = the roller shutters are fully opened.

100 % = the roller shutters are fully closed.

6. Confirm the sunshine position and return to the main menu.

OK

NOTE

The light sensor must be mounted underneath the configured sunshine position.



18.8 Automatic dawn function [☀]; brief description

EN

The automatic dawn function causes the roller shutters to open automatically to the upper end point.

When configuring opening times [▲], it is possible to link them to a switch time mode, see page 38. The calculated dawn time can be customised by linking the opening times with the [ASTRO] switch time mode. This means that it is not necessary to continuously readjust the closing time throughout the year.

Link to the opening time [▲]

The previously configured **opening time** is interpreted as “**earliest at xx:xx hours**”.

Configure a custom offset period

The calculated dawn time can be customised to personal preferences by means of an offset between **-60 and +60 minutes**. An application example for the [ASTRO] switch time mode is included on page 38.



18.8.1 Menu 5 - Customising the automatic dawn time [☀].

1. Call up the main menu.

2. Select and open menu 5 [☀] dawn function.





18.8.1 Menu 5 - Customising the automatic dawn time [☀].

EN

3. Customise the automatic dawn function in accordance with the selected switching time mode.

- 3.1. **[NORMAL]**
No customisation is possible in **[NORMAL]** switch time mode.

- a) Return to main menu.

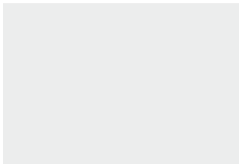
**OK**

- 3.2. **[ASTRO]**
Setting an offset.

The offset function can be used to modify the calculated Astro time by +/- **60 minutes**.

- a) Subsequently, the resulting opening time is displayed.
- b) Return to main menu.

**OK**



18.9 Menu 6 - Configuring the random function []

The random function enables a random delay of the set timer periods ranging between 0 and 30 minutes.

The random function is executed for:

- ◆ all automatic opening and closing times.

NOTE



When the random function is activated, the corresponding icon flashes in the standard display during the period that the movement command is being delayed.

1. Call up the main menu.

2. Select and open menu 6 [] **Random function.**



3. Select and confirm the desired setting.



- On** = random function on
OFF = random function off

Subsequently the main menu will be displayed again.



18.10 Automatic wind function []; brief description

EN

This function enables you to use the Troll Comfort to operate, for example, connected Venetian blinds in relation to the weather conditions.

As soon as an external “**wind**” signal transducer is detected, the control signal is transferred to the Troll Comfort via one of the correspondingly configured inputs (**E1** or **E2**).

The direction of rotation in the event of wind can be configured.

The wind can be used to retract the Venetian blinds or close them as a draught stop.

If the automatic wind function is active ...

- ◆ the [] icon flashes.
- ◆ Manual operation is no longer possible.
- ◆ Automatic movement commands are no longer carried out but will be resumed as soon as the wind subsides. In each case, only the last automatic movement command is subsequently executed.

NOTE

- ◆ In manual mode, the automatic wind function remains active, for example, in order to keep an awning protected from wind at all times.
- ◆ If the direction of rotation for wind is set to DOWN and wind is detected when the drive is at the upper end position, then the drive moves back to the upper end position as soon as no more wind is detected.
- ◆ In the main menu, the **wind icon** [] is only displayed if an external input (**E1** or **E2**) is configured for the automatic wind function.

Configuration of inputs E1 / E2

see page 83, menu 9.8.6

1. Call up the main menu.



2. Select and open menu 7 [] **automatic wind function.**



3. Select and confirm the desired setting.



On = Function on

OFF = Function off

4. Configure **the direction of rotation** in the event of wind.

1 = Up

2 = Down

Subsequently the main menu will be displayed again.





18.11 Rain function []; brief description

EN

This function enables you to use the Troll Comfort to operate, for example, a connected awning in relation to the weather conditions.

As soon as an external “rain” signal transducer is detected, the control signal is transferred to the Troll Comfort via one of the correspondingly configured inputs (**E1 or E2**).

The direction of rotation in the event of rain can be configured.

The awning can be retracted (**up**) or used as a rain cover (**down**) in the event of rain.

Once the automatic rain function is active ...

- ◆ The [] icon flashes.
- ◆ Manual operation is still possible.
- ◆ Automatic movement commands are no longer carried out but will be resumed as soon as the rain subsides. In each case, only the last automatic movement command is subsequently executed.

NOTE

- ◆ The automatic rain function is switched off in manual mode.
- ◆ If the direction of rotation for rain is set to **DOWN** and rain is detected when the drive is at the upper end position, then the drive moves back to the upper end position as soon as no more rain is detected.
- ◆ In the main menu, **the rain icon** [] is only displayed if an external input (**E1 or E2**) is configured for the automatic rain function.

Configuration of inputs E1 / E2

see page 83, menu 9.8.6



18.11.1 Menu 8 - Configuring the automatic rain function [☁].

EN

1. Call up the main menu.

M

2. Select and open menu 8 [☁] **automatic rain function.**

▲

▼

OK



3. Select and confirm the desired setting.

▲

▼

OK



On = Function on

OFF = Function off

4. Configure and confirm the **direction of rotation in the event of rain.**

1 = Up

2 = Down

Subsequently the main menu will be displayed again.

▲

▼

OK









19. Menu 9 - System settings []; brief description

EN

This menu enables you to configure additional devices and system settings to customise your Troll Comfort to your individual preferences.



Menu 9 - System settings

Icon	Menu	Page
	9.1 Time and date.....	65
-	9.2 Motor running time.....	66
	9.3 Ventilation position.....	68
[PLZ]	9.4 Postcode.....	70
	9.5 Switching time program.....	71
	9.6 Blockage detection.....	73
⌘ [T]	9.7 Venetian blinds mode.....	76
-	9.8 Device settings.....	78



19.1 Menu 9.1 - Set time and date [🕒]

EN

1. Select and open menu
9.1 Time and date.



Setting order

2. Time



NOTE

Pressing a set key for an extended period causes the numbers to progress more quickly.

3. Date



4. Year

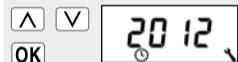



19.2 Menu 9.2 - Configure motor running time

EN

Configuring the running time allows specific targeted positions to be assumed based on the running time and roller shutter position.

The run time setting must be configured if:

- ◆ you intend to use the ventilation position function, see page 68.
- ◆ you intend to use the sunshine position function (only if automatic slat function is activated, see page 76).
- ◆ you intend to configure and have the system move to an arbitrary position, see page 32.







The running time can be detected directly by the Troll Comfort or you may, for example, measure and configure it with the help of a stopwatch.

NOTE

- ◆ Tubular motor running times can vary depending on temperature. For this reason, targeted movement to a specific position is subject to certain tolerances.
- ◆ The running time must be configured as precisely as possible in order for the desired position to be reliably assumed.
- ◆ The running time must be reconfigured if the end points are changed.
- ◆ If the running time is configured, for example, with the help of a stopwatch, then the speed should be measured in the up direction and approx. 10% should be added.

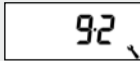

19.2 Menu 9.2 - Configure motor running time

- | | |
|---|---|
| 1. Select and open menu 9.2 motor running time . |    |
| 2. Press and hold the [Down] -key... |  ...until the roller shutters stop at the lower end point. |
| 3. Press and hold the [Up] -key... |  ...until the roller shutters stop at the upper end point. |
| 4. Release the [Up] -key. | The running time will be timed and stored during the up cycle. |
| 5. Back to system menu. |  |

Manually setting the running time

- Fully close the roller shutters.
- Subsequently move the roller shutters to the upper end point and make a note of the time required.
- Enter and confirm the measured running time in menu **9.2**.

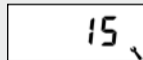

e.g. 15 sec.



19.3 Menu 9.3 - Configure ventilation position [▼]

EN

If you do not want the roller shutters to close fully to the lower end point, you can use this function to configure an arbitrary position (**e.g. as ventilation position**).

When closing automatically, the roller shutters will stop at the ventilation position, however, they can subsequently be closed completely via manual operation.

NOTE

The running time must be configured prior to setting the ventilation position, see page 66.

1. Select and open menu **9.3 - Ventilation position**.



2. Activate or deactivate the ventilation position.



On = Ventilation position on

> **continue with b)**

OFF = Ventilation position off

> **Return to menu System settings**

3. First fully open the roller shutters.





19.3 Menu 9.3 - Configure ventilation position [▼]

EN

4. Subsequently move the roller shutters to the desired position.



or

4. Enter the desired ventilation position by modifying the percentage value.



Example

0 % = the roller shutters are fully opened.

100 % = the roller shutters are fully closed.

5. Confirm the ventilation position and return to the system settings menu.

OK

NOTE

If the position in point 4 is set to 0% or 100%, then the ventilation position will be deactivated.



19.4 Menu 9.4 - Set postcode [PLZ]

EN

1. Select and open menu **9.4 - postcode.**



2. Set and confirm the **postcode.**



NOTE:

- ◆ Only the first two digits of the code are entered for German cities.
- ◆ Please refer to the time zone table on page 99 for various European cities.
- ◆ If the Troll Comfort is not being used in Germany, it may be necessary to switch off the automatic summer/winter changeover function. In order to do so, please refer to page 79 **“Activate/deactivate automatic summer/winter changeover”**.



19.5 Select Menu 9.5 - Switching time programme []

EN

The number of opening and closing times that can be configured depends on the desired **switching programme selected in this menu.**

There are three switching time programs available:

[1] Weekly switching times (factory setting)

- ◆ One switching time pair [▲ / ▼] for (MON...SUN) [**MO...SO**]

[2] Working day and weekend switching times

- ◆ One switching time pair [▲ / ▼] for (MON...FRI) [**MO...FR**]
- ◆ One switching time pair [▲ / ▼] for (SAT + SUN) [**SA + SO**]

[3] Individual day switching times

- ◆ One switching time pair [▲ / ▼] for every day of the week
(MO / TU / WE / TH / FR / SA / SU)
[**MO / DI / MI / DO / FR / SA / SO**]

Double the amount of switching times by activating a second switching time block:

If you want to double the number of configurable opening and closing times, then you must activate a second **switch time block (n=2)** here.

After this has been activated, you can configure opening and closing times for both switch time blocks, see page 37.



19.5 Select Menu 9.5 - Switching time programme []

EN

1. Select and open menu **9.5 Switching time** programme.



2. Select and confirm the desired **switching time programme**.



1 = Weekly switching times

2 = Weekend switching times

3 = Individual day switching times

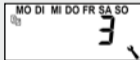

3. Configure and confirm the number of **switching time blocks**.

n 1 = one switching time block is active.

n 2 = two switching time blocks are active.

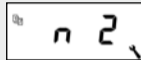

> **Recommended setting**

NOTE

The switching times are configured in menu [2], see page 41.



19.6 Menu 9.6 - Configuration of blockage detection []

EN

The Troll Comfort is able to monitor the torque of motors equipped with a mechanical end point setting. This enables the controller to switch off the motor in the event of overloading or blockage. As a result, the roller shutters are protected from damage.

NOTE

Blockage detection can only be used in combination with a tubular motor which has **a mechanical end point setting**.

1. Select and open menu **9.6 Blockage detection**.



2. Activate / deactivate and confirm **blockage detection**.



On = blockage detection on

> **Continue with point 3**

OFF = blockage detection off

> **Back to system menu**



19.6 Menu 9.6 - Configuration of blockage detection []

EN

3. Select and confirm the suitable **motor type**.



In order to do so, please refer to the operating manual for the appropriate tubular motor.

Motor types

Diameter / Power

1:06	35 mm / 6 Nm
1:10	35 mm / up to 10 Nm
2:10	45 mm / up to 10 Nm
2:20	45 mm / up to 20 Nm
2:30	45 mm / up to 30 Nm
2:40	45 mm / up to 40 Nm
2:50	45 mm / up to 50 Nm



If the installed motor type is unknown, please select:

- 1:06** for roller shutters with an area up to 1.5 m²
- 2:30** for larger roller shutters

4. Set and confirm the **sensitivity** level.

Sensitivity:

- 1** = low
- 6** = high



NOTE

- ◆ Test runs should be made to ascertain the highest possible level of sensitivity, in order to protect the roller shutters in the event of blockage.
- ◆ It may be necessary to customise the **cut-off sensitivity** depending on the properties of the roller shutters (weight, running characteristics, etc.).



19.6 Menu 9.6 - Configuration of blockage detection []

EN

5. Activate / deactivate
**reversing after block-
age detection.**

On = reversing on
OFF = reversing off

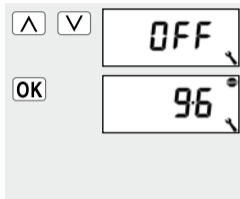

Automatic reversing in the event of meeting an obstacle.

In the event of blockage, the motor runs in the opposite direction for approx. 2 seconds to relieve the roller shutters.

More information about blockage detection:

- ◆ If long connecting leads are used (>5 m), it is possible that the blockage detection system will fail to work correctly due to external interference.

- ◆ It is possible that the motor will be switched off by the blockage detection system when moving out of the end points when using mechanical motors with high switching hysteresis. Blockage detection must be deactivated for this type of motor.

NOTE:

- ◆ Some motors can trigger undesired reversing when reaching the end positions (e.g. atypical internal motor wiring, long cables, etc.) In such cases it is recommended to deactivate the reversing function.
 - ◆ If the motor type cannot be precisely determined, then a suitable setting for motor type and sensitivity must be determined by trial and error.
-

This function enables you to use the Troll Comfort to control Venetian blinds.

The following configurations are possible:

- ◆ Jog mode
- ◆ Automatic slat adjustment
- ◆ Tilting time

Brief description of jog mode

Jog mode enables Venetian blinds slats to be conveniently configured. Briefly tapping the operating buttons enables the slats to be conveniently configured.

In order to conveniently move the Venetian blinds to the end points, activate the control key for 1 second longer than the configured tilting time. Once the key is released, the Venetian blinds will move to the end point without stopping.

Brief description of automatic slat adjustment function

If the Troll Comfort controls the motor in the down-direction until the total running time has elapsed or the Venetian blinds motor is stopped manually, then the motor reverses automatically for a brief period (automatic slat adjustment). This serves to position the slats to the desired angle, in order to provide sun shading to the room.

NOTE

- ◆ If the motor is actuated by the automated solar function to the sunshine position, then automatic slat adjustment is not executed.
 - ◆ The light sensor must be mounted as low as possible under the configured sunshine position.
-

19.7 Menu 9.7 - Venetian blinds mode [# / T]; brief description

EN

1. Select and open menu **9.7 - Venetian blinds mode**.



2. Activate or deactivate **jog mode** and confirm.



On = on
OFF = off

3. Activate/deactivate and confirm automatic slat adjustment.



On = on
OFF = off

> **Continue with point 4**
> **Back to system menu**

4. Set and confirm the tilting time.



Setting range:

OFF or





0.1 to 5.00 seconds

5. Confirm the previous setting and return to the "System settings" menu.





Menu 9.8 - Device settings

Icon	Menu	Page
	<i>9.8.1</i> Automatic summer / winter changeover.....	79
	<i>9.8.2</i> Display contrast	80
	<i>9.8.3</i> Display backlighting	80
	<i>9.8.4</i> Clock mode.....	81
	<i>9.8.5</i> Key lock.....	82
	<i>9.8.6</i> Inputs E1/E2	83
	<i>9.8.7</i> Reversal of rotation direction..	85
[L]	<i>9.8.8</i> Light function.....	86
	<i>9.8.9</i> End points	89
	<i>9.8.0</i> Software version	92

19.8.1 Menu 9.8.1 - Automatic summer/winter changeover on/off

The Troll Comfort features an automatic summer/winter changeover function.

NOTE

If the controller is not being used in Germany, it may be necessary to switch off the automatic summer / winter clock change function.

1. Select and open menu **9.8.1 Summer/winter changeover.**



2. Activate/deactivate **summer/winter changeover** and confirm.



On = Function on

OFF = Function off



19.8.2 Menu 9.8.2 - Set display contrast

EN

1. Select and open menu **9.8.2 - Display contrast**.

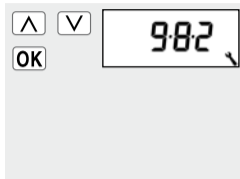

2. Set and confirm the desired display contrast.

- 1** = low contrast
- 10** = high contrast

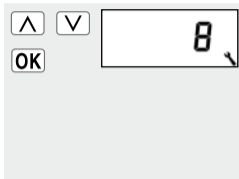

19.8.3 Menu 9.8.3 - Configure continuous display backlighting

Pressing one of the operating keys causes the backlighting in the standard display to switch on at full intensity.

Subsequently the brightness gradually fades down to the configured value.

1. Select and open menu **9.8.3 - Display backlighting**.

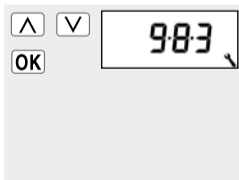

19.8.3 Menu 9.8.3 - Configure continuous display backlighting

EN

2. Configure and confirm the desired brightness.

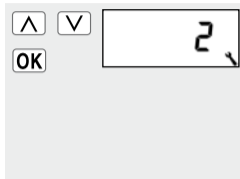

The display backlighting remains permanently switched on at the configured setting.

0 = off

1-3 = brightness levels

19.8.4 Menu 9.8.4 - Set clock mode

This menu enables you to configure the time base for the internal clock (depending on the local power supply).

1. Select and open menu **9.8.4 Clock mode.**

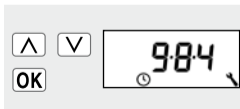

2. Set and confirm the clock mode.

1 = 50 Hz mode

2 = 60 Hz mode

3 = quartz mode

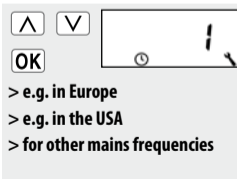



19.8.5 Menu 9.8.5 - Switch key lock on/off

EN

You can activate the key lock to protect against unintentional input.

Automatic activation after approx. two minutes.

If the key lock is activated and no keys are pressed within a period of two minutes, the key lock is activated automatically.

1. Select and open menu **9.8.5 - Key lock.**



2. Activate or deactivate the key lock.

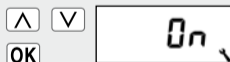

On = on

OFF = off

Press and hold the [**SET/Stop**] key for four seconds in order to remove or activate the key lock in the standard display.

NOTE

The roller shutters can be moved manually, even with the key lock activated.



approx.
4 sec.

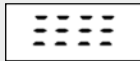

Display:

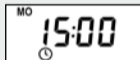

Display for active
key lock.

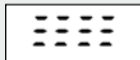

When pressing the
menu key.



19.8.6 Menu 9.8.6 - Configuration of inputs E1 / E2

EN

External controller via the two inputs E1 and E2.

The Troll Comfort features two configurable inputs **E1** and **E2** (230 V / 50 Hz) for connecting external signal transducers (e.g. Venetian blinds switch / environmental sensor, etc.).

The following configurations are possible:

- [0] Off
- [1] UP (roller shutter mode)
- [2] DOWN (roller shutter mode)
- [3] UP (Venetian blinds mode)
- [4] DOWN (Venetian blinds mode)
- [5] UP / Stop / Down
- [6] Automatic mode on/off (closer, NO)
- [7] Automatic mode on/off (opener, NC)
- [8] External wind signal, NO
- [9] External rain signal, NO

NOTE

- ◆ If manual mode is active, the inputs are not taken into consideration by the controller (except in the case of the wind function).
 - ◆ Both inputs can be configured independently of each other.
-



19.8.6 Menu 9.8.6 - Configuration of inputs E1 / E2

EN

1. Select and open menu **9.8.6 - Inputs.**



2. Enter and confirm the function for input 1 (**E1**).



3. Enter and confirm the function for input 2 (**E2**).



4. Subsequently the system menu will be displayed again.

NOTE

You can obtain application examples for inputs E1 / E2 from our website at www.rademacher.de

19.8.7 Menu 9.8.7 - Switch reversal of rotation direction on/off

EN

It is not necessary to re-wire the motor if the direction of rotation for the connected motor is wrong ([**Up**] key moves the roller shutters downwards and [**Down**] key moves the roller shutters upwards). The direction of the motor can be easily changed using the reversal of **rotation direction function**.

1. Select and open menu **9.8.7 - Reversal of rotation direction**



2. Activate or deactivate reversal of rotation direction.

On = on

OFF = off

NOTE

The following settings apply to the activated light function.

On = Appliance mode

OFF = Light mode



Light function,
see page 86

See table on
page 87



19.8.8 Menu 9.8.8 - Light function; brief description

EN

The light function makes it possible to control a connected light (or other electrical appliance) instead of a roller shutter motor with the help of the automated functions.

In addition, it is also possible to manually control the light with the buttons **[up/down and SET/stop]**.

The underlying functions of the Troll Comfort change when the light mode is activated.

When a light (or other electrical appliance) is controlled instead of a motor, the motor-related functions on the Troll Comfort are meaningless and no longer function:



- ◆ Running time
- ◆ End point setting
- ◆ Jog mode
- ◆ All Venetian blinds functions
- ◆ Automatic wind and rain functions
- ◆ Position of the sun and ventilation position



19.8.8 Menu 9.8.8 - Light function; brief description

EN

Switch over between lighting function and appliance modes

Command and signal	Light function off	Light function on	
	Tubular motor mode	Light mode Reversal of rotation direction [OFF]	Appliance mode Reversal of rotation direction [On]
	Up	Off	On
	Stop	Off	Off
	Down	On	Off
Dusk	Down	On	Off
Dawn	Up	Off	Off
Sun	Down	Off	No function



19.8.8 Menu 9.8.8 - Configure light function

EN

1. Select and open menu **9.8.8 - light function.**



2. Activate or deactivate the light function.



- On** = on
OFF = off

3. Return to main menu.



Select between lighting function and device function

If the lighting function is activated, menu **9.8.7 - reversal of rotation direction** (see page 85) can be used to select between [**light mode**] and [**appliance mode**].

You can use your Troll Comfort to configure the end points for an electronic RADEMACHER tubular motor.

NOTE

- ◆ **[SET]** is additionally displayed during the end point setting configuration process.
- ◆ The end point setting function is only available for RADEMACHER electronic tubular motors from 2000 onwards.
- ◆ The end point setting cannot be adjusted for tubular motors connected in parallel.
- ◆ The end point function is not available when the light function is activated.

19.8.9 Menu 9.8.9 - Configuration of end points for the tubular motor

EN

1. Select and open menu 9.8.9 - End points.



2. Allow the motor to run for at least two seconds for at least two seconds to enable the motor type to be detected.



3. Pay attention to the display:

The tubular motor type has not been detected, proceed to point 6.

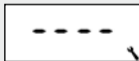

The tubular motor type has been detected, proceed to point 4.

4. Set the upper end point.
 - a) Press and hold the set button. The roller shutters travel upwards.
 - b) Release the button as soon as the desired end point is reached.

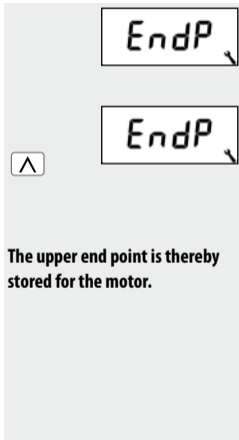

The upper end point is thereby stored for the motor.

5. Set the lower end point.

 - a) Press and hold the set button. The roller shutters travel downwards.

 - b) Release the button as soon as the desired end point is reached.

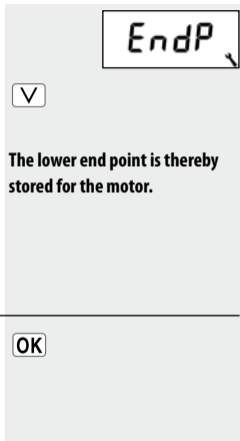

6. Back to system menu.

NOTE

The end points will only be stored if:

- ◆ The tubular motor is allowed to run for at least four seconds before an end point is reached.
- ◆ The configuration process is undertaken starting from the end point that is to be changed.
- ◆ Check the correct setting of the end points directly after completing the configuration process with the help of the operating keys.



19.8.10 Menu 9.8.0 - Display software version

EN

This menu enables the current Troll Comfort software version to be displayed.

1. Select and open menu **9.8.0 - Software version**.



2. Subsequently **the current software version** will be displayed.

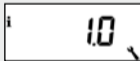

3. Pressing once more causes **the device type** to be displayed.



4. Pressing once more causes a **display test** to be carried out.



5. Back to system menu.



R 20. Software reset (restore factory settings).

EN

If necessary, you can erase all of your settings and return the Troll Comfort system to its original factory settings.

1. Simultaneously press and hold all four keys for 5 seconds, until all of the icons are shown on the display.



approx.
5 sec.

2. Next, the device type (**C = Comfort**) and software version will be displayed for a few seconds.

All settings will be erased and reset to the default factory settings. Carry out the settings again as specified from page 27 onwards (installation wizard).

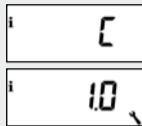

A hardware reset can be carried out in the event that the Troll Comfort fails to react to commands. To do so, pull the control unit [1] out of the installation housing [3].

The centre section on the rear of the control unit [1] contains **two contacts** which should be carefully **bridged** for a few seconds, for example, with the help of a flat-head screwdriver.

The control unit [1] can be replaced into the installation housing [3] as soon as the screwdriver has been removed from the contacts.

The time and date will be lost during a hardware reset. All other settings are retained.

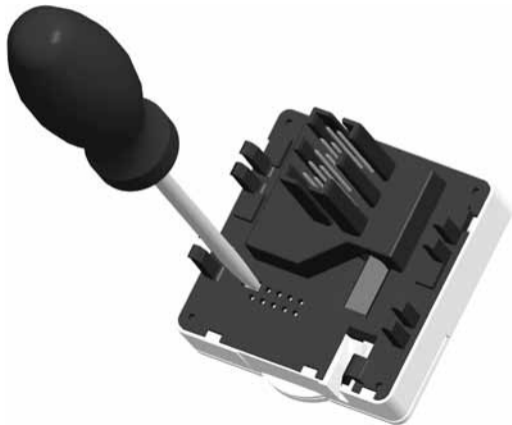



There is a risk of fatal electric shocks when dismantling the Troll Comfort.

Follow the safety instructions for electrical connection on page 21.

Procedure for dismantling:

1. Switch off the mains.
2. Secure the connector against reconnection and check that the system is de-energised.
3. Carefully remove the operating unit [1] from the installation housing [3].
4. Remove the frame [2].
5. Release the installation housing [3] from the flush-mounted box and disconnect from the mains lead.
6. Leave the connector so that it is secured against reconnection or fit with a new unit if required.

The Troll Comfort (item no. 3650 00 12 / 3650 05 22) complies with the requirements of the following European and national directives:



**2006/95/EC
Low-voltage directive**
**2004/108 EC
EMC directive**

Conformity has been verified. The corresponding declarations and documentation are available on file at the manufacturer's premises.

RADEMACHER Geräte-Elektronik GmbH & Co. KG
Buschkamp 7
46414 Rhede
Germany

i 24. Technical Specifications

External dimensions control unit [1]: 50 x 50 mm x 12 (according to DIN 49075)

Colour: ultra-white / aluminium

Nominal voltage: 230 V / 50 Hz

Max. switching capacity: 8 (4) A μ (Type 1B)

Standby consumption: <0.3 W

Extension inputs: 2 (E1 and E2), configurable

Connection diameter: 1.5 mm²

Installation depth: 32 mm

Permissible ambient temperature: 0 to 40°C

Power reserve for clock in the
event of power failure: max. 8 hours

Protection class: II (only for use in dry areas)

i 25. Works Settings

EN

Automatic:	On
Timer periods:	On
Up-time and mode:	7:00 hours / NORMAL
Down-time and mode:	20:00 hours / NORMAL
Random function:	OFF
Automatic solar function:	OFF
Motor running time:	150 seconds
Ventilating position:	OFF / 80 %
Postcode:	46
Switching programme:	1
Blockage detection:	OFF
- Motor type:	2 (45 mm / 30 Nm)
- Sensitivity:	2:30
- Reversing:	OFF

Jog mode:	OFF
Automatic slat adjustment:	OFF
Tilting time:	1.5 seconds
Automatic summer / winter changeover:	On
Display contrast:	8
Display backlighting:	0
Clock mode:	1 (50 Hz)
Key lock:	OFF
Inputs E1 / E2:	OFF / OFF
Reversal of direction of rotation:	OFF
Light function:	OFF

Belgium

- 101 Antwerp
- 102 Bruges
- 103 Brussels
- 104 Liege
- 105 Mechelen
- 106 Mons
- 107 Ostend

Denmark

- 108 Aalborg
- 109 Ringsted
- 110 Esbjerg
- 111 Horsens
- 112 Kolding
- 113 Copenhagen
- 114 Svendborg
- 115 Randers

England

- 116 Aberdeen
- 117 Birmingham
- 118 Bristol
- 119 Glasgow
- 120 London
- 121 Manchester
- 122 Newcastle

Estonia

- 123 Tallinn

Finland

- 124 Helsinki
- 125 Jyväskylä
- 126 Oulu
- 127 Tampere
- 128 Turku
- 129 Vasa

France

- 130 Bordeaux
- 131 Brest
- 132 Dijon
- 133 Le Havre
- 134 Lyon
- 135 Montpellier
- 136 Nantes
- 137 Nice
- 138 Paris
- 139 Reims
- 140 Strasbourg
- 141 Toulon

Italy

- 142 Bologna
- 143 Bolzano
- 144 Florence
- 145 Genoa

- 146 Milan
- 147 Naples
- 148 Palermo
- 149 Rome
- 150 Turin
- 151 Venice

Ireland

- 152 Cork
- 153 Dublin
- 154 Belfast

Latvia

- 155 Riga

Liechtenstein

- 156 Vaduz

Lithuania

- 157 Vilnius

Luxembourg

- 158 Luxembourg

The Netherlands

- 159 Amsterdam
- 160 Eindhoven
- 161 Enschede
- 162 Groningen
- 163 Maastricht
- 164 Rotterdam
- 165 Utrecht

Norway

- 166 Oslo
- 167 Stavanger
- 168 Bergen
- 169 Trondheim

Austria

- 170 Amstetten

- 171 Baden
- 172 Braunau
- 173 Brixen
- 174 Bruck/Mur
- 175 Eisenstadt
- 176 Graz
- 177 Innsbruck
- 178 Klagenfurt
- 179 Landeck
- 180 Linz
- 181 Nenzing
- 182 Salzburg
- 183 Vienna

Poland

- 184 Wroclaw
- 185 Bromberg
- 186 Gdansk
- 187 Kattowitz

i 26. Time zone table

EN

188 Cracow
189 Lodz
190 Lublin
191 Posen
192 Stettin
193 Warsaw

Portugal

194 Faro
195 Lisbon
196 Porto

Switzerland

197 Basel
198 Bern
199 Andermatt
200 Chur
201 Lausanne
202 Lucerne

203 Zurich

Sweden

204 Boras
205 Gavle
206 Göteborg
207 Helsingborg
208 Jönköping
209 Östersund
210 Malmö
211 Stockholm
212 Sundsvall
213 Umea

Spain

214 Almería
215 Alicante
216 Barcelona
217 Bilbao

218 Badajoz

219 Burgos

220 Cáceres

221 Castellón

222 Granada

223 Guadalajara

224 La Coruña

225 Lérida

226 León

227 Madrid

228 Murcia

229 Oviedo

230 Palma

231 Pamplona

232 San

Sebastián

233 Seville

234 Santander

235 Valencia

236 Valladolid

237 Vitoria

238 Saragossa

239 La Palma

240 Tenerife

241 Grand

Canaria

242 Fuerteventura

South-east Europe

243 Athens

244 Belgrade

245 Bratislava

246 Bucharest

247 Budapest

248 Istanbul

249 Maribor

250 Prague

251 Sarajevo

252 Sofia

253 Skopje

254 Thessaloniki

255 Zagreb

Information about our accessories is available at the following website:

www.rademacher.de/zubehoer

Light sensor:

Item no.	Cable length
7000 00 88	0.75 m
7000 00 89	1.5 m
7000 00 90	3 m
7000 00 91	5 m
7000 00 92	10 m

RADEMACHER Geräte-Elektronik GmbH & Co. KG provides a 24-month warranty for new systems that have been installed in compliance with the installation instructions. All construction faults, material defects and manufacturing defects are covered by the warranty.

The following are not covered by the warranty:

- ◆ Incorrect fitting or installation
- ◆ Non-observance of the installation and operating instructions
- ◆ Improper operation or wear and tear
- ◆ External influences, such as impacts, knocks or weathering
- ◆ Repairs and modifications by third-party, unauthorised persons
- ◆ Use of unsuitable accessories
- ◆ Damage caused by unacceptable excess voltage (e.g. lightning)
- ◆ Operational malfunctions caused by radio frequency overlapping and other such radio interference

RADEMACHER shall remedy any defects that fall under the warranty period free of charge, either by repairing or replacing the affected parts, or by supplying a new replacement unit or one of equivalent value. There is no general extension of the original warranty period upon delivery of a replacement or due to repair, as per the terms of the warranty.

RADEMACHER

Geräte-Elektronik GmbH & Co. KG

Buschkamp 7

46414 Rhede (Germany)

info@rademacher.de

www.rademacher.de

Service:

Hotline 01805 933-171*

Fax +49 2872 933-253

service@rademacher.de

* 14 cents / minute from a German landline network operated by DT AG/
Mobile charges max. 42 cents / minute (applies to Germany only)